

IP20 SELV  RoHS

### Driver LCAI 35W 900mA–1750mA ECO SR

ECO series

#### Product description

- Independent dimmable LED Driver
- Constant current LED Driver
- Output current adjustable between 900 – 1,750 mA
- Max. output power 35 W
- Nominal life-time up to 100,000 h
- 5-year guarantee
- Dimming range 1 ... 100 %

#### Properties

- Casing: polycarbonate, white
- Rapid installation of cable clamp and terminal cover, no tool required
- Large connection compartment
- Type of protection IP20
- Accessory LCF 12V FAN DRIVER fits into the secondary wiring area of the LED Driver

#### Interfaces

- DALI DEVICE Type 6
- DSI
- switchDIM (with memory function)
- corridorFUNCTION
- Input for temperature sensor (LED temperature monitoring)

#### Functions

- Adjustable output current (I-select resistor or DALI)
- Power-up fading at AC
- Intelligent Temperature Guard (overtemperature protection)
- Short-circuit proof
- Overload protection
- Constant Light Output function
- Suitable for emergency escape lighting systems acc. to EN50172

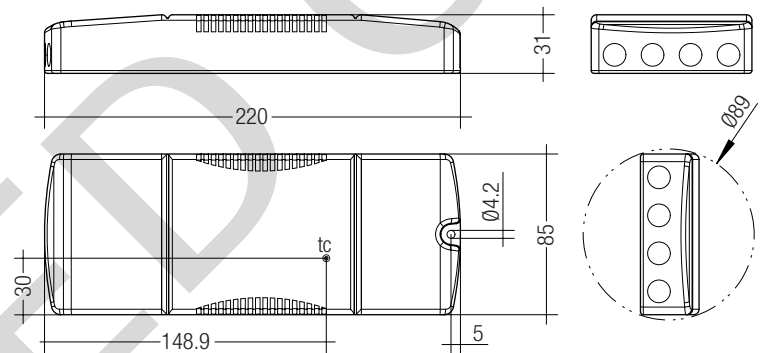

#### Ordering data

Type	Article number	Packaging carton	Packaging pallet	Weight per pc.
LCAI 35W 900mA-1750mA ECO SR	28000127	10 pc(s).	400 pc(s).	0.272 kg



**Standards**, page 5

### Technical data

Rated supply voltage	220 – 240 V
Input voltage, AC	198 – 264 V
Input voltage, DC	176 – 280 V
Mains frequency	0 / 50 / 60 Hz
Overvoltage protection	320 V AC, 48 h
Typ. current (at 230 V, 50 Hz, full load) <sup>①</sup>	173 – 184 mA
Typ. current (220 V, 0 Hz, full load, 15 % dimming level) <sup>②</sup>	32 – 37 mA
Leakage current (PE)	< 0,3 mA
Max. input power	42 W
Typ. efficiency (at 230 V / 50 Hz / full load) <sup>③</sup>	85 – 88 %
$\lambda$ (at 230 V, 50 Hz, full load) <sup>④</sup>	$\approx$ 0,98
Typ. power input on stand-by <sup>⑤</sup>	70 – 100 mW
THD (at 230 V, 50 Hz, full load)	< 5 %
Time to light (at 230 V, 50 Hz, full load, acc. to DALI)	< 0,6 s
Time to light (DC mode)	< 0,2 s
Switchover time (AC/DC)	< 0,2 s
Turn off time (at 230 V, 50 Hz, full load)	< 20 ms
Hold on time (at 230 V, 50 Hz, full load) <sup>⑥</sup>	< 14 ms
Output current tolerance <sup>⑦</sup>	$\pm$ 3 %
Output LF current ripple (< 120 Hz)	< 2 %
Max. peak output current	$\leq$ output current + 18 %
PWM frequency <sup>⑧</sup>	500 Hz
Dimming range	1 – 100 %
Max. output voltage	60 V
Burst / surge peaks output side against PE	1,2 kV
Dimensions L x W x H	220 x 85 x 31 mm

### Specific technical data

Type	Output current <sup>①</sup>	Min. forward voltage	Max. forward voltage <sup>②</sup>	Max. output power <sup>③</sup>	Typ. power consumption (at 230 V, 50 Hz, full load)	Typ. current consumption (at 230 V, 50 Hz, full load)	Max. casing temperature $t_c$	Ambient temperature $t_a$ max.	I-select resistor value
	900 mA	17 V	39,0 V	35 W	3,99 W	173 mA	70 °C	-25 ... +60 °C	Open
	950 mA	16 V	37,0 V	35 W	4,00 W	174 mA	70 °C	-25 ... +60 °C	69,80 k $\Omega$
	1,000 mA	15 V	35,0 V	35 W	4,01 W	174 mA	70 °C	-25 ... +60 °C	64,90 k $\Omega$
	1,050 mA	14 V	33,5 V	35 W	4,02 W	175 mA	70 °C	-25 ... +60 °C	56,00 k $\Omega$
	1,100 mA	14 V	32,0 V	35 W	4,03 W	175 mA	70 °C	-25 ... +60 °C	47,50 k $\Omega$
	1,150 mA	13 V	30,5 V	35 W	4,03 W	175 mA	70 °C	-25 ... +60 °C	43,20 k $\Omega$
	1,200 mA	12 V	29,5 V	35 W	4,04 W	175 mA	70 °C	-25 ... +60 °C	40,20 k $\Omega$
	1,250 mA	12 V	28,0 V	35 W	4,04 W	176 mA	70 °C	-25 ... +60 °C	36,50 k $\Omega$
	1,300 mA	12 V	27,0 V	35 W	4,05 W	176 mA	70 °C	-25 ... +60 °C	32,40 k $\Omega$
<b>LCAI 35W 900mA-1750mA ECO SR</b>	1,350 mA	11 V	26,0 V	35 W	4,05 W	176 mA	70 °C	-25 ... +60 °C	28,70 k $\Omega$
	1,400 mA	11 V	25,0 V	35 W	4,06 W	176 mA	75 °C	-25 ... +60 °C	22,00 k $\Omega$
	1,450 mA	10 V	24,5 V	35 W	4,06 W	177 mA	75 °C	-25 ... +60 °C	17,80 k $\Omega$
	1,500 mA	10 V	23,5 V	35 W	4,07 W	177 mA	75 °C	-25 ... +60 °C	15,00 k $\Omega$
	1,550 mA	10 V	23,0 V	35 W	4,08 W	177 mA	75 °C	-25 ... +60 °C	12,10 k $\Omega$
	1,600 mA	9 V	22,0 V	35 W	4,09 W	178 mA	75 °C	-25 ... +60 °C	9,31 k $\Omega$
	1,650 mA	9 V	21,5 V	35 W	4,10 W	178 mA	75 °C	-25 ... +60 °C	6,49 k $\Omega$
	1,700 mA	9 V	21,0 V	35 W	4,11 W	179 mA	80 °C	-25 ... +60 °C	3,83 k $\Omega$
	1,750 mA	9 V	20,0 V	35 W	4,12 W	179 mA	80 °C	-25 ... +60 °C	Short circuit (0 $\Omega$ )

<sup>①</sup> Valid at 100 % dimming level.

<sup>②</sup> Depending on the selected output current.

<sup>③</sup> Depending on the DALI traffic at the interface.

<sup>④</sup> At power failure.

<sup>⑤</sup>  $\pm$  20 %.

<sup>⑥</sup> At full load.

<sup>⑦</sup> Output current is mean value.

**Product description**

- Ready-for-use resistor to set output current value
- Resistor is base isolated
- Resistor power 0.25 W
- Resistor value tolerance  $\pm 1\%$

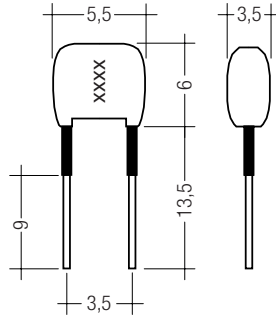

**Ordering data**

Type	Article number	Colour	Marking	Resistor value	Packaging bag	Weight per pc.
I-SELECT PLUG 950mA BR	28000370	Brown	0950	69.80 k $\Omega$	10 pc(s).	0.001 kg
I-SELECT PLUG 1000mA BR	28000459	Brown	1000	64.90 k $\Omega$	10 pc(s).	0.001 kg
I-SELECT PLUG 1050mA BR	28000279	Brown	1050	56.00 k $\Omega$	10 pc(s).	0.001 kg
I-SELECT PLUG 1100mA BR	28000460	Brown	1100	47.50 k $\Omega$	10 pc(s).	0.001 kg
I-SELECT PLUG 1200mA BR	28000461	Brown	1200	40.20 k $\Omega$	10 pc(s).	0.001 kg
I-SELECT PLUG 1300mA BR	28000462	Brown	1300	32.40 k $\Omega$	10 pc(s).	0.001 kg
I-SELECT PLUG 1400mA BR	28000280	Brown	1400	22.00 k $\Omega$	10 pc(s).	0.001 kg
I-SELECT PLUG 1500mA BR	28000464	Brown	1500	15.00 k $\Omega$	10 pc(s).	0.001 kg
I-SELECT PLUG 1600mA BR	28000464	Brown	1600	9.30 k $\Omega$	10 pc(s).	0.001 kg
I-SELECT PLUG 1700mA BR	28000464	Brown	1700	3.83 k $\Omega$	10 pc(s).	0.001 kg
I-SELECT PLUG MAX GR	28000274	Grey	MAX	0 $\Omega$	10 pc(s).	0.001 kg

**Product description**

- Fan driver module with 12.4 V output voltage
- Drives the fan permanently (independent of the optional temperature sensor)
- Terminal IN1 / IN2: stranded wires 0.2 mm<sup>2</sup>, stripped wire endings twisted and tin-plated
- Terminal FAN+ / FAN- and OUT1 / OUT2: 0.2 – 0.75 mm<sup>2</sup> solid or stranded wires twisted and tin-plated, strip wires 6 – 7 mm
- Max. output power of the LED Driver will be reduced by the power consumption of the fan and LCF 12V FAN DRIVER

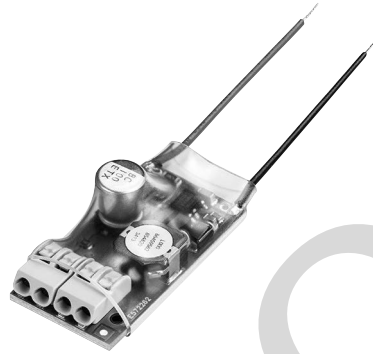

**Technical data**

Input voltage, DC	25 – 120 V
Output voltage DC	12.4 V
Max. output current (input voltage 25 – 49 V)	50 mA
Max. output current (input voltage 50 – 120 V)	70 mA
Max. power consumption incl. fan (at 30 mA)	0.55 W
Max. power consumption incl. fan (at 50 mA)	0.90 W
Max. power consumption incl. fan (at 70 mA)	1.25 W
tc point	75 °C
Ambient temperature ta (at life-time 50,000 h)	-25 ... +65 °C
Dimensions LxWxH	45 x 23 x 14 mm

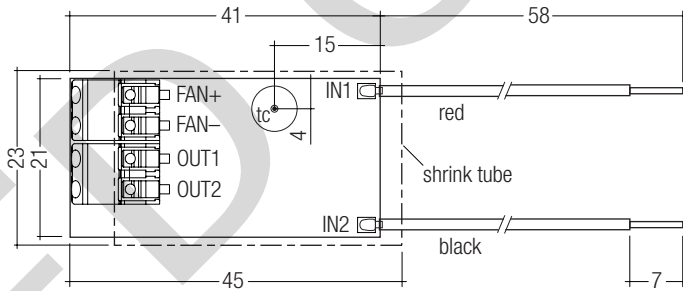

**Ordering data**

Type	Article number	Packaging carton	Packaging pallet	Weight per pc.
LCF 12V FAN DRIVER	28000932	50 pc(s).	1,200 pc(s).	0.01 kg

**Standards**

EN 55015  
 EN 61000-3-2  
 EN 61000-3-3  
 EN 61347-1  
 EN 61347-2-13  
 EN 62384  
 EN 61547  
 EN 62386-101 (according to DALI standard V1)  
 EN 62386-102  
 EN 62386-207  
 According to EN 50172 for use in central battery systems  
 According to EN 60598-2-22 suitable for emergency lighting installations

**Overload protection**

If the output voltage range is exceeded the LED Driver turns off the LED output. After restart of the LED Driver the output will be activated again. The restart can either be done via mains reset or via interface (DALI, DSI, switchDIM).

**Overtemperature protection**

The LED Driver is protected against temporary thermal overheating. If the temperature limit is exceeded the output current of the LED is reduced. The temperature protection is activated approx. +5 °C above  $t_{c\ max}$  (see page 2). On DC operation this function is deactivated to fulfill emergency requirements.

**Short-circuit behaviour**

In case of a short circuit at the LED output the LED output is switched off. After restart of the LED Driver the output will be activated again. The restart can either be done via mains reset or via interface (DALI, DSI, switchDIM).

**No-load operation**

The LED Driver will not be damaged in the no-load operation. The output will be deactivated and therefore free of voltage. If a LED load is connected the device has to be restarted before the output will be activated again.

**Hot plug-in**

Hot plug-in is not recommend within 5 s after shutdown due to output voltage of > 0 V. If a LED load is connected the device has to be restarted before the output will be activated again. This can be done with mains reset, DALI, DSI or switchDIM.

**Conditions of use and storage**

Humidity: 5 % up to max. 85 %, not condensed (max. 56 days/year at 85 %)

Storage temperature: -40 °C up to max. +80 °C

The devices have to be within the specified temperature range ( $t_a$ ) before they can be operated.

**Glow wire test**

according to EN 61347-1 with increased temperature of 850 °C passed.

**Expected life-time**

Type	Output current	$t_a$	40 °C	50 °C	55 °C	60 °C
	< 1400 mA	$t_c$	60 °C	60 °C	65 °C	70 °C
		Life-time	> 100,000 h	100,000 h	75,000 h	50,000 h
LCAI 35W 900mA-1750mA ECO SR	1400 – 1650 mA	$t_c$	60 °C	65 °C	70 °C	75 °C
		Life-time	> 100,000 h	100,000 h	75,000 h	50,000 h
	≥ 1650 mA	$t_c$	60 °C	70 °C	75 °C	80 °C
		Life-time	> 100,000 h	100,000 h	75,000 h	50,000 h

The LED Driver is designed for a life-time stated above under reference conditions and with a failure probability of less than 10 %.

**Maximum loading of automatic circuit breakers**

Automatic circuit breaker type	C10	C13	C16	C20	B10	B13	B16	B20	Inrush current
Installation Ø	1.5 mm <sup>2</sup>	1.5 mm <sup>2</sup>	2.5 mm <sup>2</sup>	4 mm <sup>2</sup>	1.5 mm <sup>2</sup>	1.5 mm <sup>2</sup>	2.5 mm <sup>2</sup>	4 mm <sup>2</sup>	$I_{max}$ time
LCAI 35W 900mA-1750mA ECO SR	26	36	42	50	13	18	21	25	4 A 22 µs

**Harmonic distortion in the mains supply (at 230 V / 50 Hz and full load) in %**

	THD	3.	5.	7.	9.	11.
LCAI 35W 900mA-1750mA ECO SR	< 5	5	1	1	1	1

### Control input (DA/N, DA/L)

Digital DALI signal or switchDIM can be wired on the same terminals (DA/N and DA/L).

### Digital signal DALI/DSI

The control input is non-polar for digital control signals (DALI, DSI). The control signal is not SELV. Control cable has to be installed in accordance to the requirements of low voltage installations.

Different functions depending on each module.

### switchDIM

Integrated switchDIM function allows a direct connection of a push to make switch for dimming and switching.

Brief push (< 0.6 s) switches LED Driver ON and OFF. The LED Drivers switch-ON at light level set at switch-OFF.

When the push to make switch is held, LED modules are dimmed. After repush the LED modules are dimmed in the opposite direction.

In installations with LED Drivers with different dimming levels or opposite dimming directions (e.g. after a system extension), all LED Drivers can be synchronized to 50 % dimming level by a 10 s push.

Use of push to make switch with indicator lamp is not permitted.

### corridorFUNCTION

The corridorFUNCTION can be programmed in two different ways.

To program the corridorFUNCTION by means of software a DALI-USB interface is needed in combination with a DALI PS. The software can be the masterCONFIGURATOR.

To activate the corridorFUNCTION without using software a voltage of 230 V simply has to be applied for five minutes at the switchDIM connection.

The unit will then switch automatically to the corridorFUNCTION.

#### Note:

If the corridorFUNCTION is wrongly activated in a switchDIM system (for example a switch is used instead of pushbutton), there is the option of installing a pushbutton and deactivating the corridorFUNCTION mode by five short pushes of the button within three seconds.

switchDIM and corridorFUNCTION are very simple tools for controlling ballasts with conventional momentary-action switches or motion sensors.

To ensure correct operation a sinusoidal mains voltage with a frequency of 50 Hz or 60 Hz is required at the control input.

Special attention must be paid to achieving clear zero crossings. Serious mains faults may impair the operation of switchDIM and corridorFUNCTION.

### Dimming

Dimming range 1 % to 100 %

Digital control with:

- DSI signal: 8 bit Manchester Code  
Speed 1 % to 100 % in 1.4 s
  - DALI signal: 16 bit Manchester Code  
Speed 1 % to 100 % in 0.2 s
- Programmable parameter:  
Minimum dimming level  
Maximum dimming level  
Default minimum = 1 %  
Programmable range  $1\% \leq \text{MIN} \leq 100\%$   
Default maximum = 100 %  
Programmable range  $100\% \geq \text{MAX} \geq 1\%$

Dimming curve is adapted to the eye sensitiveness.

Dimming is realized by a combination of analog amplitude dimming and PWM dimming.

35 ... 100 %: amplitude dimming

1 ... 34 %: PWM dimming

### Dimming characteristics

Digital dimming value

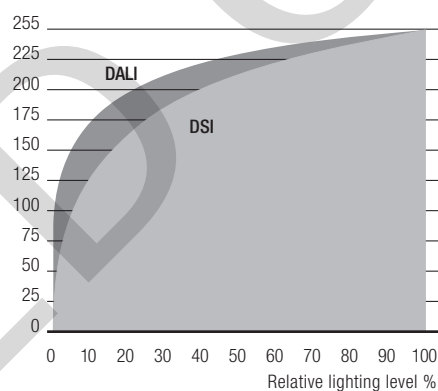

Dimming characteristics as seen by the human eye

### DC emergency operation

The LED Driver is designed for operation on DC voltage and pulsed DC voltage.

Light output level programmable from 1 – 100 %  
Programming by extended DSI or DALI signal (16 bit).  
Default value is 15 %

In DC operation dimming mode can be activated.

The voltage-dependent input current of Driver incl. LED module is depending on the used load.

The voltage-dependent no-load current of Driver (without or defect LED module) is for:

AC: 20.5 mA

DC: 5.5 mA

**Function: adjustable current (I-select)**

The output current of the LED Driver can be selected between 900 and 1,750 mA. For adjustment there are two options available.

## Option 1: „I-select resistor“

in 50 mA steps adjustable (see page 2, specific technical data, „I-select resistor value“).

Relationship between output current and resistor value can be found at the table “Specific technical data”. Resistor values specified from standardised resistor value ranges. Resistor value tolerance has to be  $\leq 1\%$ . Resistor power has to be  $\geq 0.1$  W.

If the resistor is connected with wires a max. wire length of 2 m may not be exceeded and possible interferences have to be avoided.

Resistors for the main output current values can be ordered from Tridonic (see accessories).

## Option 2: DALI

Adjustment is done by masterCONFIGURATOR (see masterCONFIGURATOR documentation).

**Constant light output (CLO)**

The luminous flux of an LED decreases constantly over the life-time. The CLO function ensures that the emitted luminous flux remains stable. For that purpose the LED current will increase continuously over the LED life-time. In masterCONFIGURATOR it is possible to select a start value (in percent) and an expected life-time. The LED Driver adjusts the current afterwards automatically.

**Intelligent temperature monitoring (ITM)**

The device offers the possibility to connect a silicon based temperature sensor (KTY81-210, KTY82-210) to monitor the LED temperature and protect the module against thermal damages.

If the temperature limit is exceeded the LED output will be dimmed or turned off. If the temperature falls below threshold the device will automatically return to the nominal operation.

The use of a NTC or PTC resistor is not possible.

The device can be operated without a sensor (default setting).

The function can be adjusted via masterCONFIGURATOR.

**Power-up fading**

The power-up fading function offers the opportunity to realise a soft start. The soft start will be applied at turning on the mains and at starts by switchDIM.

The function is programmed as a DALI fade time in the range from 0.7 to 16 seconds and dims in the selected time from 0 % to the power-on level. By factory default power-up fading is not active (0 seconds).

**Programming**

With appropriate software and a USB interface different functions can be activated and various parameters can be configured in the LED Driver. All that is needed is a DALI-USB and the software (masterCONFIGURATOR).

**masterCONFIGURATOR**

At version 2.8:

For programming functions (CLO, I-SET, ITM, power-up fading, corridorFUNCTION) and device settings (fade time, ePowerOnLevel, DC level, etc.). For further information see masterCONFIGURATOR manual.

## Installation instructions

### Mains supply wires

Wiring type and cross section

Stranded wire or solid wire up to 2.5 mm<sup>2</sup> may be used for wiring. Strip 10–11 mm of insulation from the cables to ensure perfect operation of the push terminals.

Use one wire for each terminal connector only.

Use each strain relief channel for one cable only.

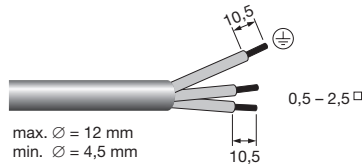

### Secondary wires (LED module)

Wiring type and cross section

The wiring can be in stranded wires with ferrules or solid with a cross section of 0.2–1.5 mm<sup>2</sup>.

Strip 8.5–9.5 mm of insulation from the cables to ensure perfect operation of the push-wire terminals.

Use one wire for each terminal connector only.

Use each strain relief channel for one cable only.

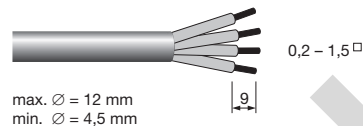

### Fixing conditions

Dry, acidfree, oilfree, fatfree. It is not allowed to exceed the maximum ambient temperature (t<sub>a</sub>) stated on the device. Minimum distances stated below are recommendations and depend on the actual luminaire.

Is not suitable for fixing in corner.

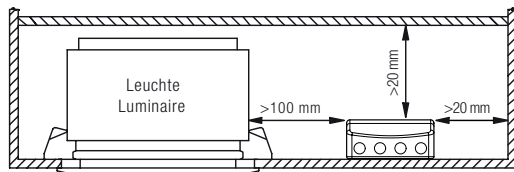

### Release of the wiring

Press down the "push button" and remove the cable from front.

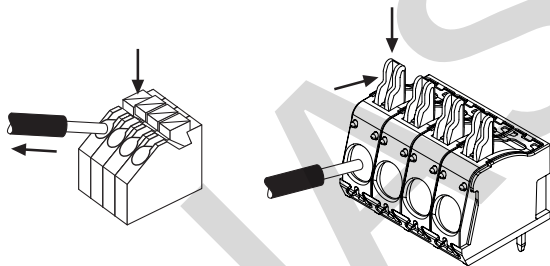

### Wiring guidelines

- The cables should be run separately from the mains connections and mains cables to ensure good EMC conditions.
- The LED wiring should be kept as short as possible to ensure good EMC. The max. secondary cable length is 2 m (4 m circuit), this applies for LED output as well as for I-SET and temperature sensor.
- The LED Driver has no inverse-polarity protection on the secondary side. Wrong polarity can damage LED modules with no inverse-polarity protection.
- Secondary switching is not permitted.
- The possibility to loop-through L, N, and PE of the input terminals is meant to wire several control gears in series. A maximum continuous current of 12 A must not be exceeded at the terminal.

### Installation note

Max. torque at the clamping screw: 0.5 Nm / M4

### Isolation and electric strength testing of luminaires

Electronic devices can be damaged by high voltage. This has to be considered during the routine testing of the luminaires in production.

According to IEC 60598-1 Annex Q (informative only!) or ENEC 303-Annex A, each luminaire should be submitted to an isolation test with 500 V<sub>DC</sub> for 1 second. This test voltage should be connected between the interconnected phase and neutral terminals and the earth terminal.

The isolation resistance must be at least 2 MΩ.

As an alternative, IEC 60598-1 Annex Q describes a test of the electrical strength with 1500 V<sub>AC</sub> (Or 1.414 x 1500 V<sub>DC</sub>). To avoid damage to the electronic devices this test must not be conducted.

### Earth connection

The earth connection is conducted as protection earth (PE). If the LED Driver will be earthed, protection earth (PE) has to be used. There is no earth connection required for the functionality of the LED Driver. Earth connection is recommended to improve following behaviour.

- Electromagnetic interferences (EMI)
- LED glowing at stand-by
- Transmission of mains transients to the LED output

In general it is recommended to earth the LED Driver if the LED module is mounted on earthed luminaire parts respectively heat sinks and thereby representing a high capacity against earth.

### Additional information

Additional technical information at [www.tridonic.com](http://www.tridonic.com) → Technical Data

Guarantee conditions at [www.tridonic.com](http://www.tridonic.com) → Services

Life-time declarations are informative and represent no warranty claim. No warranty if device was opened.



**Circuit diagram**

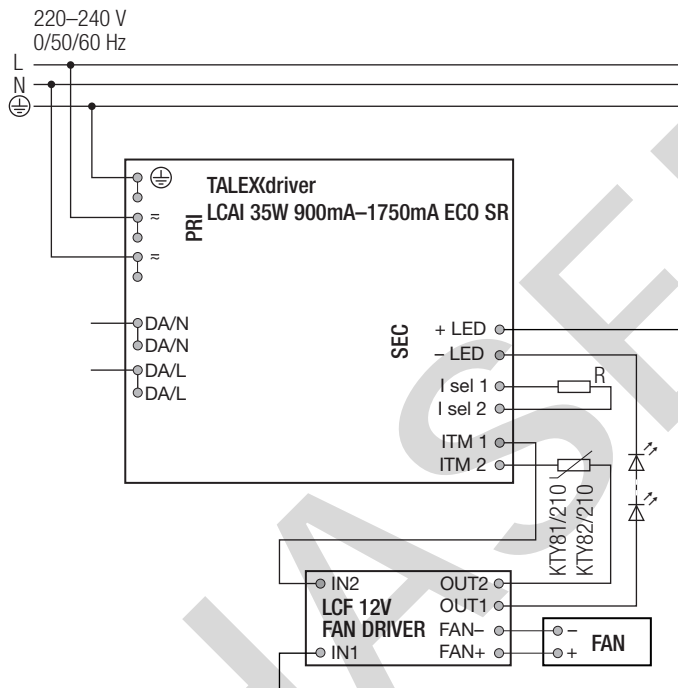
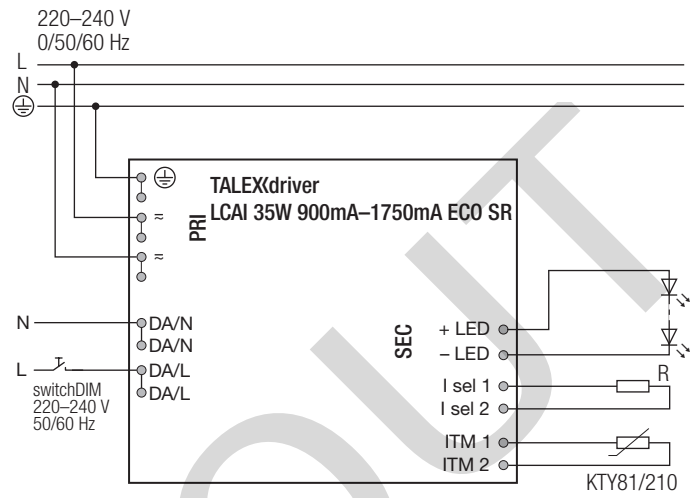
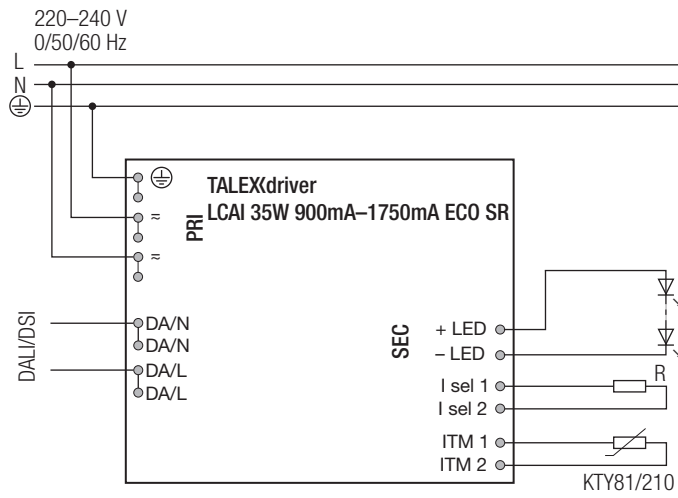

**Diagrams LCAI 35W 900mA-1750mA ECO SR**

Efficiency vs load

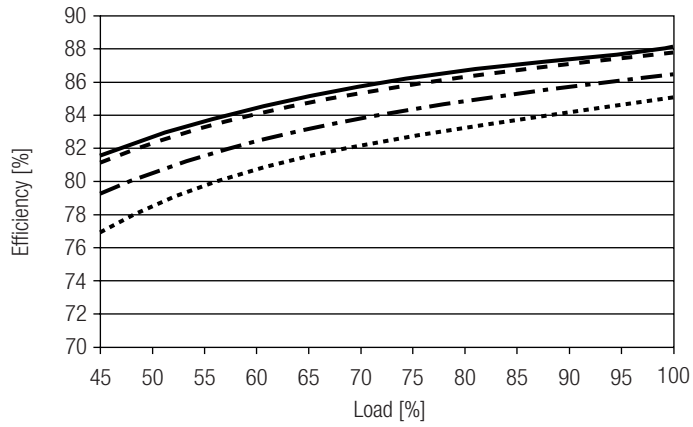

Power factor vs load

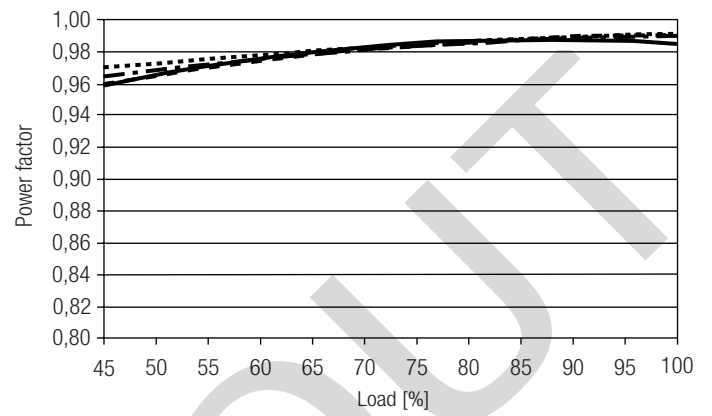

THD vs load

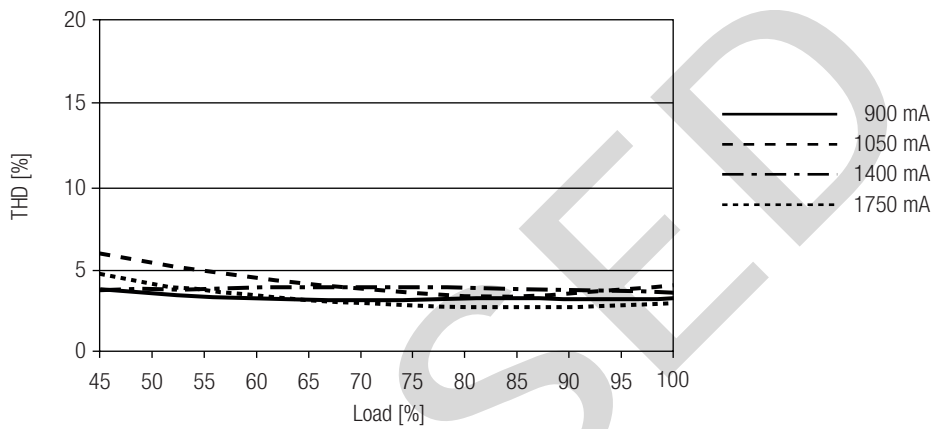

100 % load correspond to the max. output power (full load) according to the table on page 2.