

VT	Datenblatt	
	Data sheet	

Type **F 55-4-1.2**
Type **FHE 55-4-1.2**
Type **FT 55-4-1.2**
Type **FTHE 55-4-1.2**

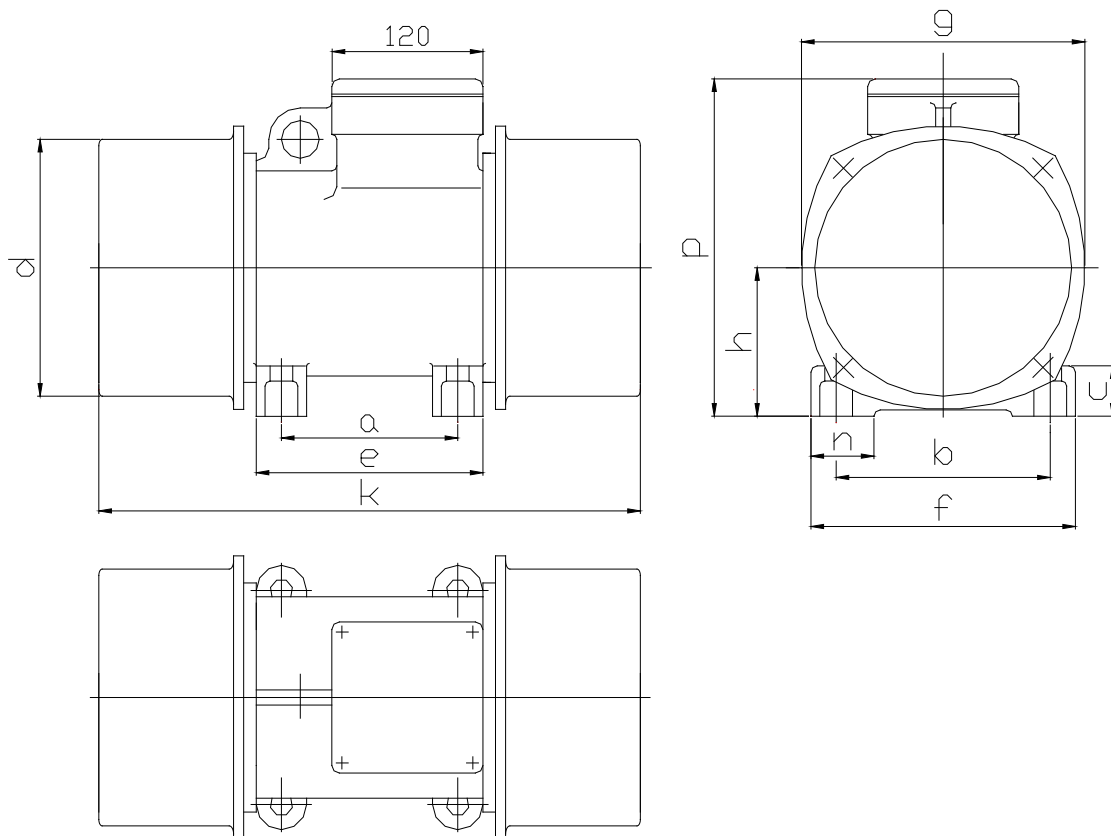

Maße / Dimensions [mm]

a	b	c	d	e	f	g	h	k	n	p
140	170	40	161	192	210	180	94	424	45	234

Technische Daten / Technical data

Spannung Voltage	Frequenz Frequency	Leistungs- aufnahme Power consumption	Nennstrom Nominal current	Leistungsfaktor Power factor	Anzugsmoment Starting current ratio
[V]	[Hz]	[kW]	[A]	cosφ	I_A / I_N
230/400	50	0,30	1,50/0,86	0,75	4,4

Fliehkraft Centrifugal force	Arbeitsmoment Working moment	Befestigungs- Schrauben Hexagon screw	Gewicht weight
[N]	[kgcm]		[kg]
6450	55	8.8 4xM16	35