



Component Systems for Lighting Applications



For Discharge Lamps

Ballasts, Control Gear Units,
Ignitors, Power Switches,
Capacitors and Lampholders

For Fluorescent Lamps

Ballasts, Capacitors, Lampholders,
Starter Lampholders, Terminal
Blocks and Accessories

For Incandescent Lamps

Transformers and Lampholders

For Emergency Lighting

Emergency lighting modules,
Rechargeable Batteries and
Supports

UPDATE!

1	Vossloh-Schwabe Projects	4-5	3	Electromagnetic ballasts for TC and T Lamps	152-163
2	Ballasts for Discharge Lamps	6-40		For compact fluorescent lamps	154-158
	Electronic ballasts, accessories	8-13		Standard ballasts	154-157
	Luminaire protection device SP 230/10K	13		Ballasts 120 V, 60 Hz	158
	Control gear units for HS and HI lamps	14-16		For tubular fluorescent lamps	159-163
	Electromagnetic ballasts	17-40		Standard ballasts	160-162
	for HS and HI lamps	17-31		Ballasts 120 V, 60 Hz	163
	for HM and HI lamps	32-34	3	Lampholders and Accessories for TC Lamps	164-182
	for power reduction	35-40		G24, GX24 lampholders	166-171
2	Ignitors and Accessories for Discharge Lamps	42-62		2G7 lampholders	172
	Electronic superimposed ignitors	44-52		G23 lampholders	173-175
	Pulse ignitors	53-54		GR8, GR10q, GRY10q-3, GRZ10d,	
	Instant restrike ignitors	55-56		GRZ10t lampholders	175-176
	Electronic power switches	57		2G10 lampholders	176
	Electronic superimposed ignitors with power switch	58		2G11/2GX11 lampholders	177-178
	Switch units for electronic operating devices with 1-10 V interface	59		Accessories	179-181
	Start-up switches	60-61	3	Lampholders and Accessories for T Lamps	184-214
	Electronic discharge units	62		G5 lampholders	186-193
2	Lampholders for Discharge Lamps	64-82		G5 lampholders, accessories	186-190
	E27 lampholders	66-68		G5 twin lampholder	191
	E40 lampholders	69-70		G5 lampholders, degree of protection IP54/IP65/IP67	191-192
	G8.5 lampholders	71		2GX13 lampholders, accessories	193
	GX8.5 lampholders, accessories	71		G13 lampholders	194-214
	GU6.5 lampholders	72		G13 push-through lampholders	194-196
	PGJ5 lampholders	73		G13 push-fit lampholders	197-199
	GX10 lampholders	74		G13 push-fit twin lampholders, accessories	200-201
	GX9.5 lampholders	75		G13 built-in lampholders	201-204
	G12, GX12-1, PG12-1, PG12-2 lampholders	75-76		G13 surface-mounted lampholders	205-206
	RX7s lampholders	77-80		Accessories for T8 and T12 lamps	206-208
	Fc2 lampholders	80-81		G13 lampholders, degree of protection IP54/IP65/IP67, accessories	209-213
	K12x30s lampholders	82		G10q lampholders, accessories	214
	K12s-7 support	82	3	Starter Holders and Terminal Blocks, Accessories	216-225
2	Technical Details for Discharge Lamps	83-123		Starter holders, accessories	218-221
3	Electronic Ballasts for TC and T Lamps	124-150		Terminal blocks, accessories	222-224
	For compact fluorescent lamps	126-141		Built-in rocker switches	225
	ELXc - Warm start - linear casing shape	126	3	Technical Details for Fluorescent Lamps	226-253
	ELXd - Dimmable - linear casing shape	127-128		Parallel capacitors	254-259
	ELXc - Warm start - compact casing shape	129-137		Technical details for parallel capacitors	260-268
	ECO EffectLine	135	4	Parallel Capacitors	254-268
	ELXd - Dimmable - compact casing shape	138-141			
	For tubular fluorescent lamps	142-149			
	ELXc - Warm start - linear casing shape	142-146			
	EffectLine and EffectLine II	144			
	New T5 EffectLine	145			
	ECO EffectLine	146			
	ELXd - Dimmable - linear casing shape	147-149			
	Accessories for dimmable electronic built-in ballasts	150			

5	Transformers for Low-voltage Halogen Incandescent Lamps	270–275	6	Emergency Lighting Modules for TC and T Lamps	358–364
	Independent electronic converters	272		Emergency lighting modules	
	Electronic built-in converters	273–274		with self-diagnosis function	348–349
	Electromagnetic safety transformers	2175		Technical details for emergency lighting modules	350–356
5	Lampholders for Low-voltage Halogen Incandescent Lamps	276–285	7	Components for UL Market	358–364
	G4, GZ4, G5.3, GX5.3, G6.35, GY6.35 lampholders, accessories	278–279		For discharge lamps	360–361
	G4 lampholders, GZ4 lamp connectors	279–281		For fluorescent lamps	361–364
	Lampholders with separate mounting spring for GU4 lamps	282	8	General Technical Details	366–374
	GX5.3 lamp connectors	283			
	GU5.3 lampholders	283–284	9	Glossary	375–377
	Lampholders with separate mounting spring for GU5.3 lamps	284–285			
	G6.35, GY6.35 lampholders, GZ6.35 lamp connectors	285	10	Table of Reference Numbers and Approval Marks	378–388
	G53 lamp connectors	285			
5	Lampholders for Mains Voltage Halogen Incandescent Lamps	286–295			
	B15d, BA15d lampholders	286			
	G9 lampholders, accessories	286–288			
	GU10, GZ10 lampholders, accessories	289–290			
	R7s thermoplastic lampholders	291–293			
	R7s ceramic lampholders	317–319			
	R7s metal lampholders	293			
	Connection boxes	294			
	Connectors	295			
5	Lampholders for General-service Incandescent and Retrofit Lamps	297–332			
	E14 lampholders	298–307			
	E14 thermoplastic lampholders, one-piece and cover caps	298–302			
	E14 table lamp set	303			
	E14 thermoplastic lampholders, three-piece	303–305			
	E14 metal lampholders, three-piece	306			
	E14 thermoplastic rocker switch lampholders	307			
	E27 lampholders	307–324			
	E27 thermoplastic lampholders, one-piece and cover caps	307–312			
	E27 table lamp set	313			
	E27 renovation kit lampholders	313			
	E27 thermoplastic lampholders, three-piece	314–316			
	E27 porcelain lampholders	317–318			
	E27 metal lampholders, three-piece	319			
	E27 thermoplastic pull-switch lampholders	320–321			
	E27 metal pull-switch lampholders	321–322			
	E27 thermoplastic rocker switch lampholders	322–323			
	E27 festoon lampholders	323–324			
	B22d lampholders, accessories	324–325			
	Accessories for E14, E27 and B22d lampholders	326–331			
	E40 porcelain lampholders	332			
5	Technical Details for Incandescent Lamps	333–345			

LIGHT TECHNOLOGY PRODUCTS



Vossloh-Schwabe is not merely a manufacturer of top-quality components for the lighting industry, but above all a competent and innovative partner when it comes to providing the growing lighting market with cost-effective all-round solutions.

Featuring a future-proof component structure that already now satisfies both the requirements of energy-efficient lighting and European standards, VS' unique product range includes magnetic and electronic ballasts, state-of-the-art control systems (LiCS), LED lighting systems and matching operating devices.

Employing in excess of 1,000 people in more than 20 countries, Vossloh-Schwabe is represented all over the world. As a subsidiary of the Japanese Panasonic Group, VS can draw on extensive resources for R&D as well as for international expansion activities. A highly motivated workforce, comprehensive market knowledge, profound industry expertise as well as eco-awareness and environmental responsibility show Vossloh-Schwabe to be a reliable partner for the provision of optimum and cost-effective lighting solutions.

Vossloh-Schwabe's dedication to delivering superior quality is reflected in its ISO 9001 certification.

Vossloh-Schwabe is ready to embark on a collaborative journey into an economically illuminated future.

LED components are just as much a part of our product range as light control systems. Our extensive range of powerful LED modules, LED drivers, LiCS controllers and sensors is presented in our separate **Innovative Systems** catalogue.

We'll be happy to help you dimension your lighting project. Contact us.





PUMA Headquarters



Porsche Museum

1

2

3

4

5

6

7

8

9

10

PUMA Headquarters, Herzogenaurach

As the secret "capital of sport", the little German town of Herzogenaurach is home to the headquarters of the sport lifestyle company PUMA. Covering a total surface area of 50,000 square metres, the complex is made up of three buildings that are positioned so as to create a large central square, the PUMA Plaza.

The main aim of the lighting concept developed for the new PUMA corporate headquarters was to deliver optimum quality of light, enable maximum flexibility in using the available space and yield the greatest possible energy savings. No less than 985 electronic DALI ballasts and 4,650 standard electronic ballasts made by Vossloh-Schwabe went into implementing the lighting system.

The inner courtyard features additional red and white effect lighting in the form of ground-level linear markings created using LEDs made by Vossloh-Schwabe. These LEDs enable digital lighting sequences to flow over the square. To complement the clear-cut, rectilinear forms that characterise the entire building complex, a number of slender light columns, made of square aluminium sections, were installed to round off the courtyard's stylish appearance.

Photos: Markus Bollen

Porsche Museum, Stuttgart

The name "Porsche" both stands for a long tradition of outstanding quality and the excitement of high-octane driving. The Porsche Museum in Stuttgart constitutes a fitting presentation venue that does the brand image every justice. The architectural flagship thus serves to make the "Porsche experience" available to everyone.

The lighting installed in the Porsche Museum forms a crucial element of the exhibition space created for around 80 vehicles. It was important to ensure every detail of these high-end cars was clearly visible. In this regard, direct and reflecting lighting had to be reduced to an absolute minimum so as to neither irritate visitors, nor detract from the brilliant gloss of the bodywork.

This forms another instance in which Vossloh-Schwabe products have helped to add to the enjoyment of each and every visitor. Built-in electronic ballasts and electronic DALI safety converters ensure flicker-free, efficient light.

ELECTRONIC AND ELECTROMAGNETIC

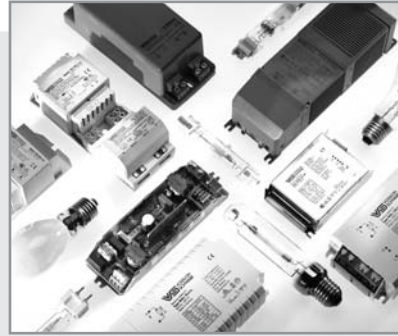

ELECTRONIC AND ELECTRO-MAGNETIC OPERATING DEVICES

For high-pressure sodium lamps (HS), metal halide lamps (HI) and mercury vapour lamps (HM)

Electronic ballasts

Modern discharge lamps operate very efficiently in combination with electronic ballasts. The numerous advantages of using electronic ballasts to operate high-pressure discharge lamps are listed in more detail on the product pages.

With the help of temperature and service-life tests, VS electronic ballasts guarantee a high degree of reliability. The quality of the electronic ballasts is ensured by continuous in-circuit tests and function tests like burn-in tests.

Magnetic ballasts

The electrical specifications of VS' range of ballasts comply with lamp-specific requirements. Vossloh-Schwabe attaches great importance to ensuring the impedance value of electromagnetic ballasts is kept within particularly narrow tolerances. This advantage, which is achieved by individual adjustment of the air gap during the automated production and testing process of every ballast, decisively contributes to optimising light output, light colour and service life of discharge lamps.

The range includes ballasts with variable voltage tapping points and varying degrees of inherent heating as well as encapsulated devices.

2

Ballasts for Discharge Lamps

For high-pressure sodium lamps (HS), metal halide lamps (HI) and mercury vapour lamps (HM)

Electronic ballasts, accessories

Luminaire protection device SP 230/10K

8-13

13

Control gear units for HS and HI lamps

14-16

Electromagnetic ballasts

For HS and HI lamps

For HM and HI lamps

For power reduction

17-40

17-31

32-34

35-40

Technical details for discharge lamps

General technical details

Glossary

83-123

366-474

375-377

1

2

3

4

5

6

7

8

9

10

Compact Electronic Ballasts for HI Lamps 20 and 35 W

Shape: K35

Casing: heat-resistant polyamide, encapsulated with polyurethane (EHXc 35G.327 B and EHXc 35G.327 I)
 For ceramic discharge tube lamps (C-HI)
 Power factor: > 0.9
 Operation frequency: 135 Hz
 Push-in terminals: 0.5-1.5 mm²
 Constant power consumption
 Protection against "no load" operation
 For luminaires of protection class I and II
 Degree of protection: IP20
 Permissible load capacity: 120 pF
 RFI-suppressed
 Fixing brackets for screws M4 for base mounting
 No flickering of defective lamps

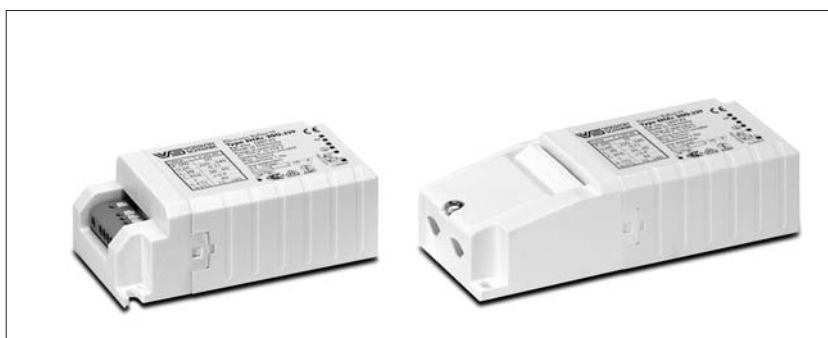

K35

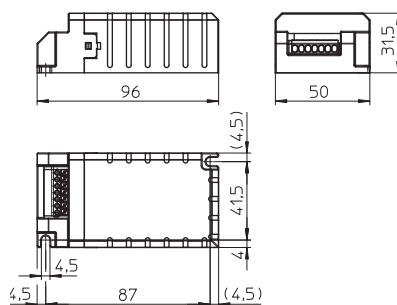

K35 with cord grip

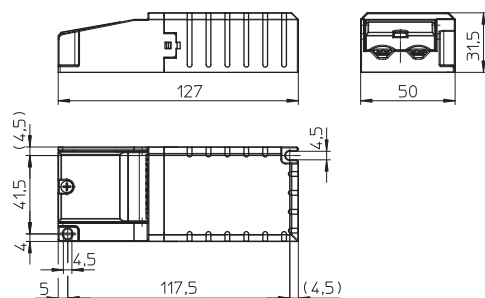

Lamp				Electronic ballast									System
Output W	Type	Base	Power consumption W	Type	Ref. No.	Voltage AC 50, 60 Hz V -10%+6%	Mains current A	Energy efficiency	Ambient temperature t _a (°C)	Casing temperature t _c (°C)	Ignition voltage kV	Weight g	Output W
Electronic built-in ballasts													
35	HI	GU6.5, G8.5, GX8.5, GX10, G12	1 x 39	EHXc 35G.327 B	188993	220-240	0.2	A2	-15 to 45	max. 80	2-4	180	43.5
Independent electronic ballasts with cord grip													
35	HI	GU6.5, G8.5, GX8.5, GX10, G12	1 x 39	EHXc 35G.327 I	188994	220-240	0.2	A2	-15 to 45	max. 80	2-4	195	43.5

Circuit diagrams see page 89

Electronic Ballasts for HI Lamps 35, 50 and 70 W

Shape: M3/K34

- Casing: aluminium (M3), heat-resistant polycarbonate (K34)
- For ceramic discharge tube lamps (C-HI)
- Power factor: ≥ 0.95
- Ignition voltage: max. 5 kV
- Operation frequency: 173 Hz
- Push-in terminals with lever opener: 0.75–2.5 mm²
- Total harmonic distortion: $< 10\%$
- Temperature protection
- Constant power consumption
- Protection against "no load" operation
- For luminaires of protection class I (metal casing)
- For luminaires of protection class I and II (plastic casing)
- Degree of protection: IP20
- Permissible load capacity: 20–120 pF
- RFI-suppressed
- Fixing brackets for screws M4 for base mounting
- No flickering of defective lamps

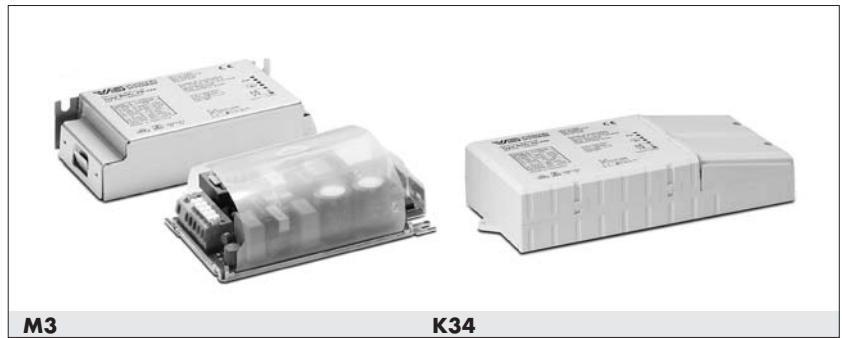

M3

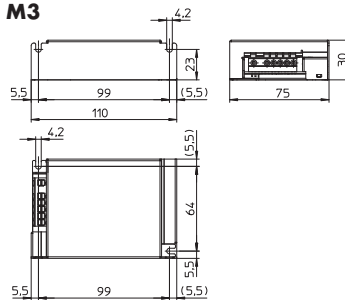

K34 with cord grip

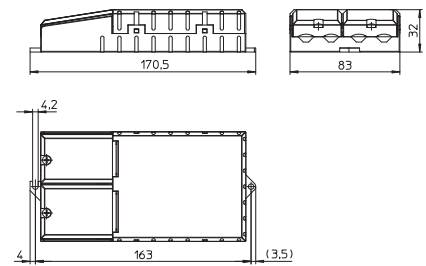

M3 built-in PCB

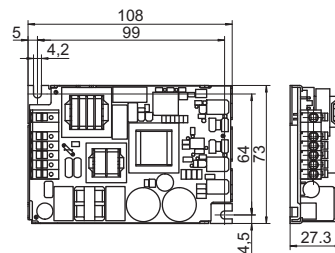

t_c point definition

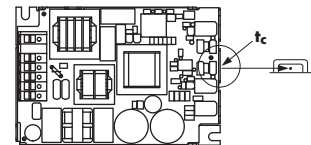

Lamp			Electronic ballast									System	
Output W	Type	Base	Power consumption W	Type	Ref. No.	Voltage AC 50, 60 Hz V $\pm 10\%$	Mains current A	Energy efficiency	Ambient temperature t _a (°C)	Casing temperature t _c (°C)	Weight g	Output W	
Electronic built-in ballast (with cap)													
35	HI	GU6.5, G8.5, GU8.5, GX8.5, G12, E27	1 x 39	EHXc 35.325	183033	220–240	0.20–0.18	A2	–20 to 65	max. 80	220	43	
50	HI	G8.5, G12	1 x 50	EHXc 50.358	183028	220–240	0.26–0.24	A2	–20 to 60	max. 80	220	55	
70	HI	G8.5, GU8.5, GX8.5, G12, PG12-2, E27, RX7s	1 x 73	EHXc 70.326	183036	220–240	0.36–0.34	A2	–20 to 55	max. 80	220	80	
Built-in PCB – Electronic built-in ballasts (without cap)													
35	HI	GU6.5, G8.5, GU8.5, GX8.5, G12, E27	1 x 39	EHXc 35.325	183034	220–240	0.20–0.18	A2	–20 to 65	max. 80	180	43	
50	HI	G8.5, G12	1 x 50	EHXc 50.358	183030	220–240	0.26–0.24	A2	–20 to 60	max. 80	180	55	
70	HI	G8.5, GU8.5, GX8.5, G12, PG12-2, E27, RX7s	1 x 73	EHXc 70.326	183037	220–240	0.36–0.34	A2	–20 to 55	max. 80	180	80	
Independent electronic ballasts with cord grip													
35	HI	GU6.5, G8.5, GU8.5, GX8.5, G12, E27	1 x 39	EHXc 35.325	183035	220–240	0.20–0.18	A2	–20 to 65	max. 75	260	43	
50	HI	G8.5, G12	1 x 50	EHXc 50.358	183029	220–240	0.26–0.24	A2	–20 to 60	max. 70	260	55	
70	HI	G8.5, GU8.5, GX8.5, G12, PG12-2, E27, RX7s	1 x 73	EHXc 70.326	183038	220–240	0.36–0.34	A2	–20 to 55	max. 75	260	80	

Circuit diagrams see page 89

Cord Grip for Electronic Built-in Ballasts

For shape K31 and K32

By using the cord grip electronic built-in ballasts for metal halide lamps become independent ballasts.

Material: heat-resistant polycarbonate

For use with electronic built-in ballasts with casing K31 and K32

For mains leads:

HO3VV-F 3X0.75 or NYM 3X1.5 mm²

For lamp leads: SIHY-Cu 3X1 mm²

or SIHSI-Cu 3X1 mm²

Weight: 50 g

Unit: 20 pcs.

By turning the cable clamp by 180° the lead diameter can be reduced to 5 mm.

Ref. No.: 188080

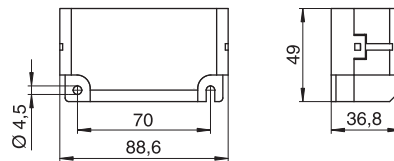
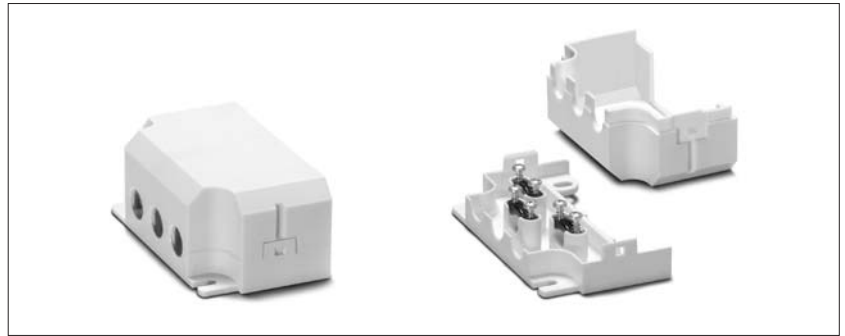

Electronic Ballasts for HI Lamps 100 and 150 W

Shape: M36/K31/K38

Casing: aluminium (M36),
heat-resistant polycarbonate (K31, K38)
For ceramic discharge tube lamps (C-HI)
Power factor: 0.98
Ignition voltage: max. 5 kV
Operation frequency: 170 Hz
Push-in terminals with lever opener: 0.75-2.5 mm²
Total harmonic distortion: < 10%
Temperature protection
Constant power consumption
Protection against "no load" operation
For luminaires of protection class I and II
Degree of protection: IP20
Permissible load capacity: 20-240 pF
RFI-suppressed
Fixing brackets for screws M4
for base mounting

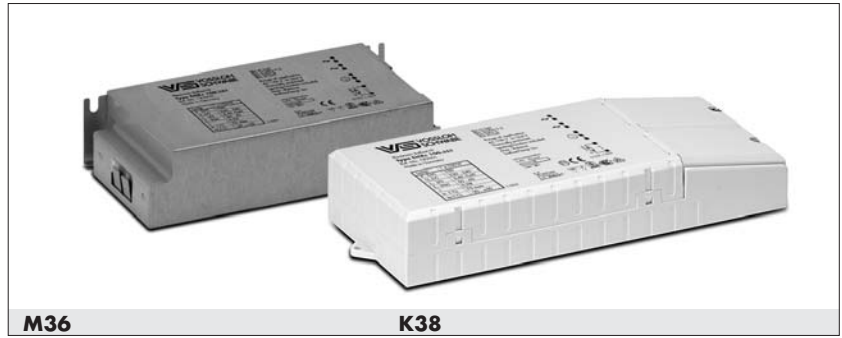

M36

K38



K31

M36

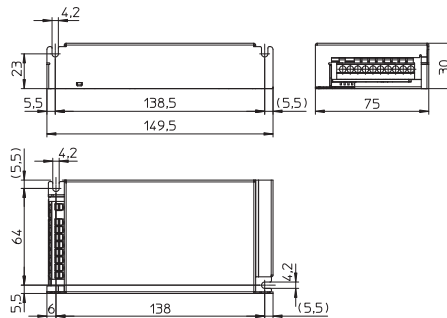

K38

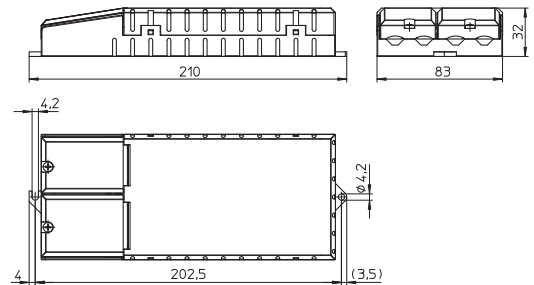

K31

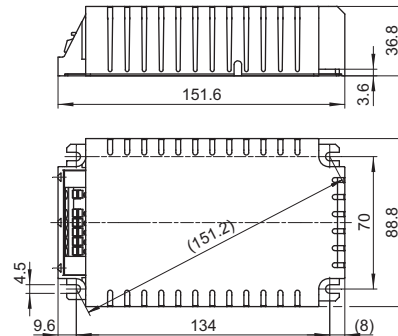

K31 with cord grip

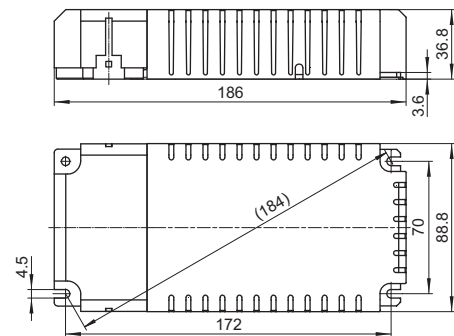

Electronic Ballasts for HI Lamps 100 and 150 W

Shape: M36 and K31, K38

Lamp				Electronic ballast									System
Output W	Type	Base	Power consumption W	Type	Ref. No.	Voltage AC 50, 60 Hz V ±10%	Mains current A	Energy efficiency	Ambient temperature t _a (°C)	Casing temperature t _c (°C)	Casing	Weight g	Output W
Electronic built-in ballasts													
100	HI	G12, E40	1 x 100	EHXc 100.353	183000	220-240	0.49-0.45	A2	-20 to 50	max. 75	M36	306	108
150	HI	G12, PGX12-2, E27, E40, RX7s	1 x 147	EHXc 150G.334	183046	220-240	0.73-0.67	A2	-20 to 45	max. 85	K31	540	160
Independent electronic ballasts with cord grip													
100	HI	G12, E40	1 x 100	EHXc 100.353	183001	220-240	0.49-0.45	A2	-20 to 45	max. 75	K38	350	108
150	HI	G12, PGX12-2, E27, E40, RX7s	1 x 147	EHXc 150G.334	183047	220-240	0.73-0.67	A2	-20 to 45	max. 85	K31	582	160

Circuit diagrams see page 89

Luminaire Protection Device SP 230/10K

For electronic devices

When electronic components form part of lighting systems, it is often necessary to protect such components against power-supply interruptions and electric overloads (power surges).

These can be caused by switching inductive loads or by atmospheric discharges such as lightning striking the mains or the ground. A further cause can be induced voltages from neighbouring cables when working with leading-edge phase-cutting controls.

Suitable for luminaires of protection class I and II
Solid connecting wire: 0.75 mm²
Lead length: 50 mm

The SP230/10K protection unit reduces over-voltages at the connection terminals of electronic components. The remaining residual voltage is then reduced to a respective protective level, based on the discharge current (see diagram below).

In our Innovative Systems catalogue you will find further products of this series.



Wiring diagram

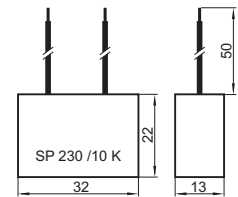
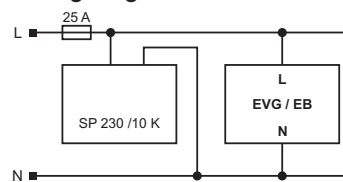

Type	Best.-Nr.	Voltage AC 50, 60 Hz V ±10%	Impulse voltage U _{OC} (V)	Impulse discharge current I _N (8/20 μs) (A)	Protection level at discharge current of 1,000 A (V)	Min. ambient temperature t _a (°C)	Casing temperature t _c (°C)	Weight g
SP 230/10 K	147230	220-240	max. 10,000	max. 10,000	≤ 850	-30		20

Bandwidth of the standard impulse: tr = 20 μs
The protection unit can withstand at least 10 spikes
of 5 kA.

Residual voltage, based on the discharge current (B)

A = Leak current | B = Protection levels

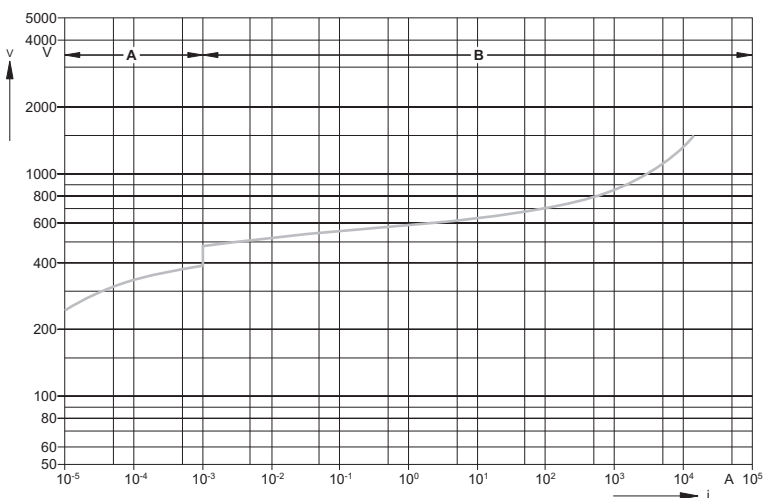

Source: Epcos Databook 2011

1

2

3

4

5

6

7

8

9

10

Control Gear Units for HS and HI Lamps 35 to 150 W

Compact plastic casing
Shape: 64 x 72 mm



For high pressure sodium lamps (HS), metal halide lamps (HI) and ceramic discharge lamps (C-HI)
Compact control gear unit with ballast with patented, intelligent thermal cut-out with automatic reset (which evaluates the temperature and current of the ballast), digital timer ignitor with IPP++ technology and compensation capacitor with thermal fuse

As individual components no longer need to be wired, there is a significant reduction in assembly time and costs.

Protection class II

- Degree of protection: IP40
- Permissible load capacity: 20-1000 pF
- Lead length to the lamp: max. 10 m
- tw 130
- Push-in terminals: 0.5-2.5 mm²
- Cord grips for mains and lamp leads
- Further outputs and voltages on request

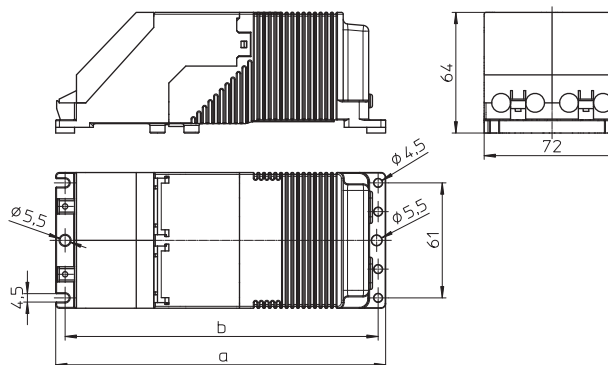

Lamp			Control gear unit									
Output W	Type	Current A	Type	Ref. No.	Voltage AC V, Hz	Mains current A	a mm	b mm	Weight kg	t _a °C	Power factor λ	Energy efficiency*
230 V, 50 Hz												
35	HS, HI	0.53	VNaHJ 35PZTG.568	536199	230, 50	0.210	175	166	1.32	55	0.92	EEI=A3
70	HS, HI	0.98	VNaHJ 70PZTG.566	535657	230, 50	0.380	175	166	1.32	45	0.91	EEI=A3
100	HS, HI	1.20	VNaHJ 100PZTG.571	536200	230, 50	0.560	214	205	1.85	45	0.85	EEI=A3
150	HS, HI	1.80	VNaHJ 150PZTG.567	535695	230, 50	0.720	214	205	2.25	45	0.91	EEI=A3
240 V, 50 Hz												
35	HS, HI	0.53	VNaHJ 35PZTG.568	536201	240, 50	0.210	175	166	1.32	55	0.94	EEI=A3
70	HS, HI	0.98	VNaHJ 70PZTG.566	536202	240, 50	0.370	175	166	1.32	40	0.94	EEI=A3
100	HS, HI	1.20	VNaHJ 100PZTG.571	536203	240, 50	0.560	214	205	1.85	40	0.86	EEI=A3
150	HS, HI	1.80	VNaHJ 150PZTG.567	536204	240, 50	0.730	214	205	2.25	40	0.91	EEI=A3
220 V, 60 Hz												
35	HS, HI	0.53	VNaHJ 35PZTG.574	536205	220, 60	0.220	175	166	1.32	60	0.98	EEI=A3
70	HS, HI	0.98	VNaHJ 70PZTG.575	536207	220, 60	0.370	175	166	1.32	50	0.97	EEI=A3
150	HS, HI	1.80	VNaHJ 150PZTG.576	536209	220, 60	0.800	214	205	2.25	45	0.98	EEI=A3

* Step 2: EEI = A3, minimum EU energy efficiency requirements as of 2012 | Step 3: A2, minimum EU energy efficiency requirements as of 2017

Control Gear Units IP65 for HS and HI Lamps 35 to 150 W

Encapsulated unit in compact plastic casing
Shape: 61 x 72 mm

For high pressure sodium lamps (HS), metal halide lamps (HI) and ceramic discharge lamps (C-HI)
Compact control gear unit with ballast with patented, intelligent thermal cut-out with automatic reset (which evaluates the temperature and current of the ballast), digital timer ignitor with IPP++ technology and compensation capacitor with thermal fuse

As individual components no longer need to be wired, there is a significant reduction in assembly time and costs.

Protection class II

Degree of protection: IP65
Permissible load capacity: 20-1000 pF
Lead length to the lamp: max. 10 m
tw 130

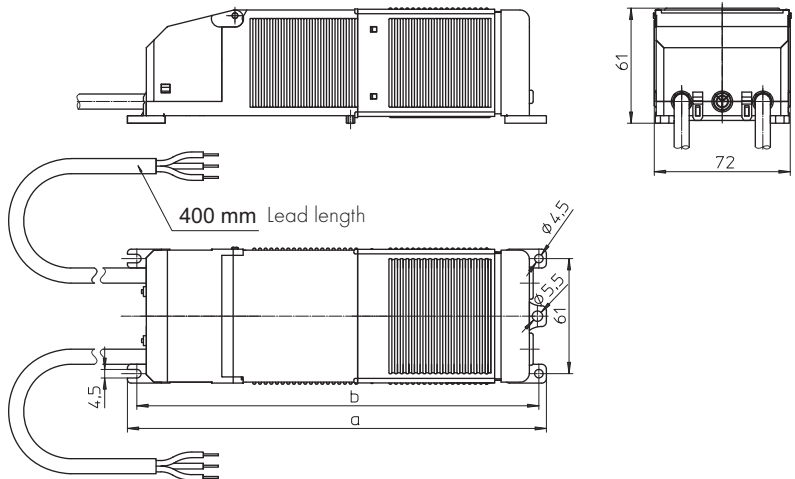

Lamp			Control gear unit									
Output W	Type	Current A	Type	Ref. No.	Voltage V, Hz	Mains current A	a mm	b mm	Weight kg	t ₀ °C	Power factor λ	Energy efficiency*
230 V, 50 Hz												
35	HS, HI	0.53	VNaHJ 35PZTG.050	533391	230, 50	0.240	222	214	1.95	60	0.96	EEI=A3
50	HS, HI	0.76	VNaH 50PZTG.058	543733	230, 50	0.290	222	214	1.95	60	0.94	EEI=A3
70	HS, HI	0.98	VNaHJ 70PZTG.051	533392	230, 50	0.370	222	214	1.95	50	0.97	EEI=A3
100	HS, HI	1.20	VNaHJ 100PZTG.078	533393	230, 50	0.560	249	240	2.25	55	0.90	EEI=A3
150	HS, HI	1.80	VNaHJ 150PZTG.052	533394	230, 50	0.740	249	240	2.75	50	0.94	EEI=A3
240 V, 50 Hz												
35	HS, HI	0.53	VNaHJ 35PZTG.053	534107	240, 50	0.240	222	214	1.95	60	0.96	EEI=A3
70	HS, HI	0.98	VNaHJ 70PZTG.054	534109	240, 50	0.370	222	214	1.95	50	0.97	EEI=A3
150	HS, HI	1.80	VNaHJ 150PZTG.055	534115	240, 50	0.730	249	240	2.75	50	0.95	EEI=A3
220 V, 60 Hz												
35	HS, HI	0.53	VNaHJ 35PZTG.041	534122	220, 60	0.220	222	214	1.95	70	0.98	EEI=A3
70	HS, HI	0.98	VNaHJ 70PZTG.067	534111	220, 60	0.370	222	214	1.95	50	0.97	EEI=A3
150	HS, HI	1.80	VNaHJ 150PZTG.068	534117	220, 60	0.800	249	240	2.25	45	0.98	EEI=A3

* Step 2: EEI = A3, minimum EU energy efficiency requirements as of 2012 | Step 3: A2, minimum EU energy efficiency requirements as of 2017

Control Gear Units for HS and HI Lamps 250 and 400 W

Shape: 76x91 mm



For high pressure sodium lamps (HS),
metal halide lamps (HI) and
ceramic discharge lamps (C-HI)
Fully wired slim, weather-proof control gear unit
with ballast with thermal cut-out with automatic reset,
capacitor, timer ignitor and connection terminal
Suitable for installation in or on pylons
Frontal cable feed using a PG thread fitting
Front access to terminals
Screw-fixed end cap
Screw terminals: 0.75-2.5 mm²
For luminaires of protection class I
Degree of protection: IP54
Permissible load capacity: 20-1000 pF
Distance to the lamp: max. 10 m
tw 130
With connection for protective earth conductor

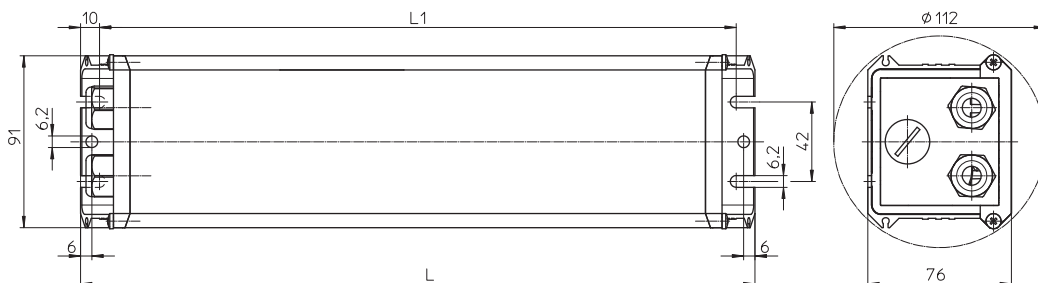

Lamp				Control gear unit							
Output W	Type	Current A	Mains current A	Type	Ref. No.	Voltage AC V, Hz	L mm	L1 mm	Weight kg	Power factor λ	Energy efficiency*
250	HS, HI	3.0	1.3	VNaHJ 250PZT.745	531476	230, 50	322	302	4.30	> 0.94	EEI=A3
400	HS, HI	4.45	2.0	VNaHJ 400PZT.743	531475	230, 50	357	337	5.62	> 0.91	A2

* Step 2: EEI = A3, minimum EU energy efficiency requirements as of 2012 | Step 3: A2, minimum EU energy efficiency requirements as of 2017

Ballast Units for HS and HI Lamps 1000 and 2000 W

Shape: 114x116 mm

For high-pressure sodium vapour lamps (HS) and metal halide lamps (HI)
Slim, weather-proof ballast unit fully wired with ballast, capacitor and connection terminal
Suitable for installation in or on pylons
With connection for protective earth conductor
Frontal cable feed using a PG thread fitting
Front access to terminals or fuses
Optional additional third PG connection for mains feed-through wiring
Screw-fixed end cap
Diverse mounting options using an assembly plate or rail
Screw terminals: 0.75 - 10 mm²
For luminaires of protection class I
tw 130

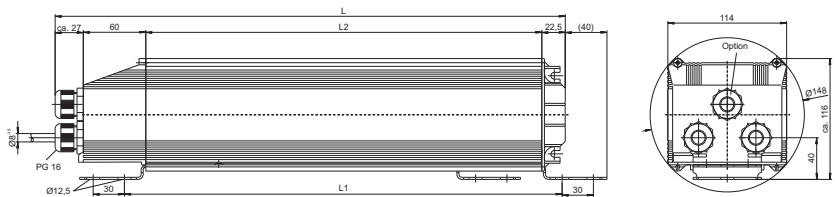

1

2

3

4

5

6

7

8

9

10

Degree of protection: IP54

Lamp				Ballast unit								
Output W	Type	Current A	Mains current A	Type	Ref. No.	Voltage AC V, Hz	L mm	L1 mm	L2 mm	Weight kg	Power factor λ	Energy efficiency*
1000	HS	10.3	5.0	VNaHJ 1000.61	531472	230 - 240, 50	487	410	370	11.6	> 0.90	A2
	HI	9.5	4.9									A2
2000	HI	10.3	6.0	VJD 2000.63	531474	380 - 400, 50	627	550	510	20.2	> 0.90	A2

* Step 2: EEI = A3, minimum EU energy efficiency requirements as of 2012 | Step 3: A2, minimum EU energy efficiency requirements as of 2017

Degree of protection: IP65

Fully encapsulated ballast unit with leads

Lamp				Ballast unit								
Output W	Type	Current A	Mains current A	Type	Ref. No.	Voltage AC V, Hz	L mm	L1 mm	L2 mm	Weight kg	Power factor λ	Energy efficiency*
1000	HS	10.3	5.0	VNaHJ 1000.61	531480	220, 50	487	410	370	11.6	> 0.90	A2
	HI	9.5	4.9									A2
2000	HI	10.3	6.0	VJD 2000.63	531481	380, 50	627	550	510	20.2	> 0.90	A2

* Step 2: EEI = A3, minimum EU energy efficiency requirements as of 2012 | Step 3: A2, minimum EU energy efficiency requirements as of 2017

Ballast Units for HS and HI Lamps 1000 to 2000 W

Encapsulated in a plastic casing

For high-pressure sodium vapour lamps (HS) and metal halide lamps (HI)
Fully encapsulated ballast unit in a self-extinguishing, fibre-glass-reinforced polyamide casing consisting of a ballast, capacitor, fuse and a ready-to-use, pre-wired connection terminal.
Cable feed using a PG thread fitting
Screw terminals: 0.75 - 10 mm²

Protection class II

tw 130

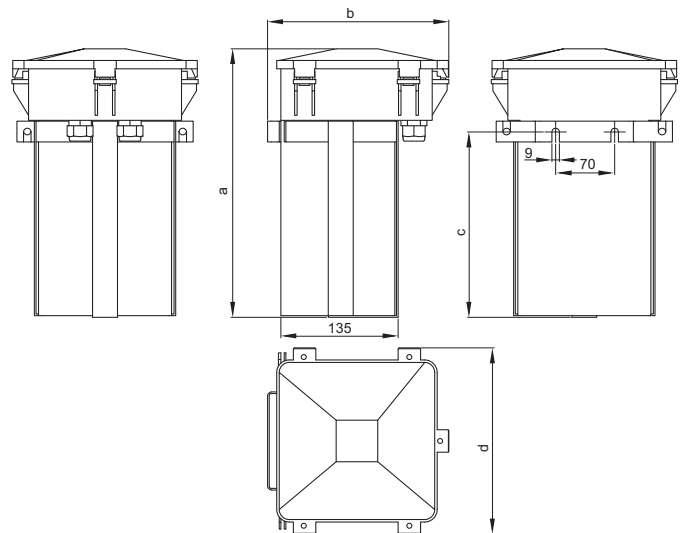

Degree of protection: IP65

With double insulation

Lamp				Ballast unit									
Output W	Type	Current A	Mains current (A)	Type	Ref. No.	Voltage AC V, Hz	a mm	b mm	c mm	d mm	Weight kg	Power factor λ	Energy efficiency*
230/240 V, 50 Hz and 380/400/415 V, 50 Hz													
1000	HS	10.3/11.3	5.75	VNaHJ 1000.75	554313	230/240, 50	288	217	–	220	15	> 0.90	A2
	HI	9.5	4.9										A2
2000	HI	8.8/9.2	5.7	VJ 2000.76	554314	380/400/415, 50	320	217	225	225	21	> 0.90	A2
2000	HI	10.3/11.3	6.0	VJD 2000.77	554315	380/400/415, 50	320	220	225	225	23	> 0.90	A2
2000	HI	12.2	6.0	VJD 2000l.78	554316	380/400/415, 50	320	220	225	225	25	> 0.90	A2
220 V, 60 Hz and 380 V, 60 Hz													
1000	HS	10.3/11.3	5.75	VNaHJ 1000.75	554904	220, 60	288	217	–	220	15	> 0.90	A2
	HI	9.5	4.9										A2
2000	HI	8.8/9.2	5.7	VJ 2000.76	554905	380, 60	320	220	225	225	21	> 0.90	A2
2000	HI	10.3/11.3	6.0	VJD 2000.77	554906	380, 60	320	220	225	225	23	> 0.90	A2
2000	HI	12.2	6.0	VJD 2000l.78	554909	380, 60	320	220	225	225	25	> 0.90	A2

* Step 2: EEI = A3, minimum EU energy efficiency requirements as of 2012 | Step 3: A2, minimum EU energy efficiency requirements as of 2017

Compact Assembly Kits for HS and HI Lamps 35 to 150 W

Ballast shape: 53 x 66 mm

For high pressure sodium lamps (HS), metal halide lamps (HI) and ceramic discharge lamps (C-HI)
Compact assembly kit with ballast with or without patented, intelligent thermal cut-out with automatic reset (which evaluates the temperature and current of the ballast), super-imposed ignitor and compensation capacitor

With luminaire terminal block:

screw terminal 0.75-2.5 mm²

With earth terminal

Permissible load capacity: 20-100 pF

Lead length to the lamp: max. 1.5 m

tw 130

On request:

Further outputs and voltages

With digital timer ignitor

For pulse ignition system

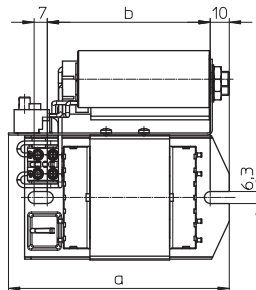
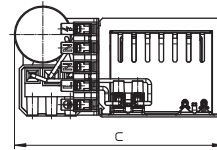
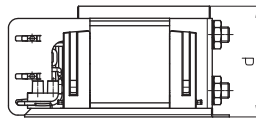
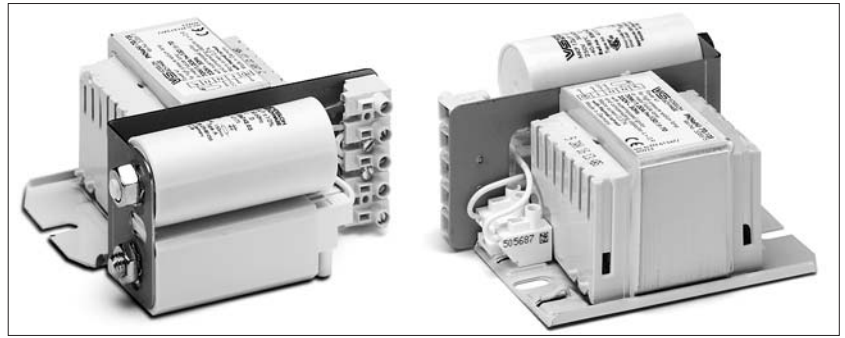

As individual components no longer need to be wired, there is a significant reduction in assembly time and costs.

Especially suitable for change of lamp technology from HM to HS.

Lamp			Assembly kit											
Output	Type	Current	Type	Ref. No.	Voltage AC	Mains current	Temperature protection	a	b	c	d	Weight	Power factor	Energy efficiency*
W		A			V, Hz	A		mm	mm	mm	mm	kg	λ	
230 V, 50 Hz														
35	HS, HI	0.53	PKNaHJ 35.008	546797	230, 50	0.22	yes	117	86	108	54	1.2	> 0.90	EEl=A3
50	HS, HI	0.76	PKNaH 50PZT.992	543378	230, 50	0.30	yes	117	86	111	59	1.4	> 0.90	EEl=A3
70	HS, HI	0.98	PKNaHJ 70.128	538675	230, 50	0.37	yes	117	86	111	59	1.4	> 0.90	EEl=A3
				538685			no							EEl=A3
100	HS, HI	1.20	PKNaHJ 100.941	538676	230, 50	0.56	yes	117	86	111	59	1.6	> 0.90	EEl=A3
				538686			no							EEl=A3
150	HS, HI	1.80	PKNaHJ 150.620	538677	230, 50	0.74	yes	151	120	115	63	2.2	> 0.90	EEl=A3
				538687			no							EEl=A3
220 V, 60 Hz														
35	HS, HI	0.53	PKNaHJ 35.008	547285	220, 60	0.23	yes	117	86	108	54	1.2	> 0.90	EEl=A3
				543401			no							
70	HS, HI	0.98	PKNaHJ 70.653	547287	220, 60	0.37	yes	117	86	111	59	1.4	> 0.90	EEl=A3
				538680			no							
100	HS, HI	1.20	PKNaHJ 100.271	538681	220, 60	0.56	no	117	86	111	59	1.6	> 0.90	EEl=A3
150	HS, HI	1.80	PKNaHJ 150.679	538682	220, 60	0.74	no	151	120	115	63	2.2	> 0.90	EEl=A3
220/240 V, 60 Hz														
100	HS, HI	1.20	PKNaHJ 100.345	543295	220/240, 60	0.60	no	117	86	111	60	1.6	> 0.90	EEl=A3
150	HS, HI	1.80	PKNaHJ 150.301	543299	220/240, 60	0.80	no	151	120	115	63	2.2	> 0.90	EEl=A3

* Step 2: EEl = A3, minimum EU energy efficiency requirements as of 2012 | Step 3: A2, minimum EU energy efficiency requirements as of 2017

Compact Assembly Kits for HS and HI Lamps 250 and 400 W

Ballast shape: 71x75 mm

For high pressure sodium lamps (HS), metal halide lamps (HI) and ceramic discharge lamps (C-HI)
Compact assembly kit with ballast with or without thermal cut-out with automatic reset, superimposed ignitor and compensation capacitor

With luminaire terminal block:

screw terminal 0.75-2.5 mm²

With earth terminal

Permissible load capacity: 20-100 pF

Lead length to the lamp: max. 1.5 m
tw 130

On request:

Further outputs and voltages

With digital timer ignitor

For pulse ignition system

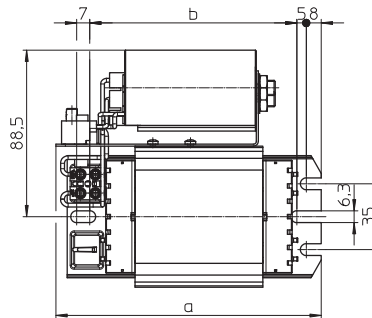
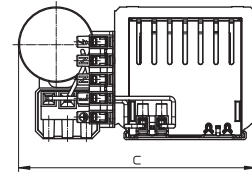
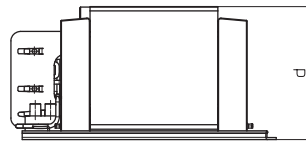
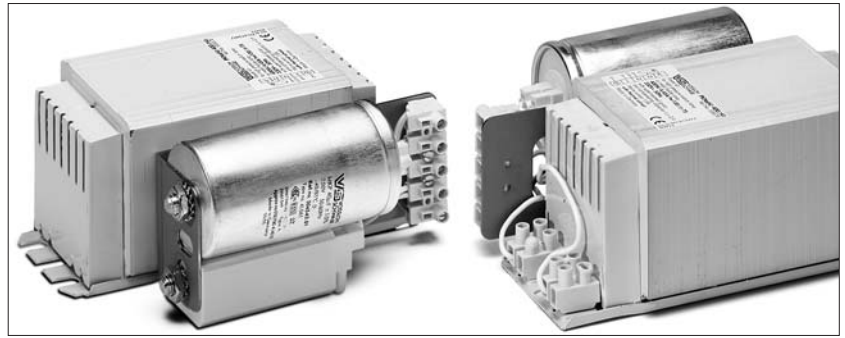

As individual components no longer need to be wired, there is a significant reduction in assembly time and costs.

Especially suitable for change of lamp technology from HM to HS.

Lamp			Assembly kit											
Output	Type	Current	Type	Ref. No.	Voltage AC	Mains current	Temperature protection	a	b	c	d	Weight	Power factor	Energy efficiency*
W		A			V, Hz	A		mm	mm	mm	mm	kg	λ	
230 V, 50 Hz														
250	HS, HI	3.00	PKNaHJ 250.741	538678	230, 50	1.20	yes	141	110	128	73	3.2	> 0.90	A2
				538688			no							A2
400	HS, HI	4.45	PKNaHJ 400.743	538679	230, 50	1.80	yes	171	140	129	73	5.2	> 0.90	A2
				538689			no							A2
220 V, 60 Hz														
250	HS, HI	3.00	PKNaHJ 250.742	538683	220, 60	1.20	no	141	110	126	71	3.2	> 0.90	A2
400	HS, HI	4.45	PKNaHJ 400.744	538684	220, 60	1.80	no	171	140	129	71	5.2	> 0.90	A2

* Step 2: EEL = A3, minimum EU energy efficiency requirements as of 2012 | Step 3: A2, minimum EU energy efficiency requirements as of 2017

Standard Ballasts for HS and HI Lamps 35 to 70 W

Shape: 53 x 66 mm

For high pressure sodium lamps (HS),
metal halide lamps (HI) and
ceramic discharge lamps (C-HI)

Vacuum-impregnated with polyester resin

Screw terminals: 0.5-2.5 mm²

Protection class I

tw 130

Ballasts for pulse ignition system on request

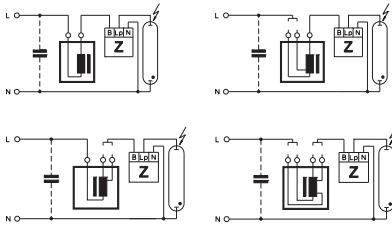
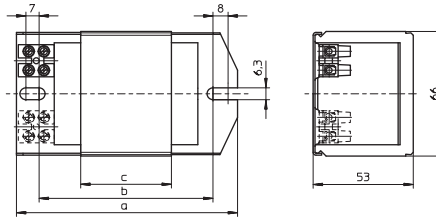
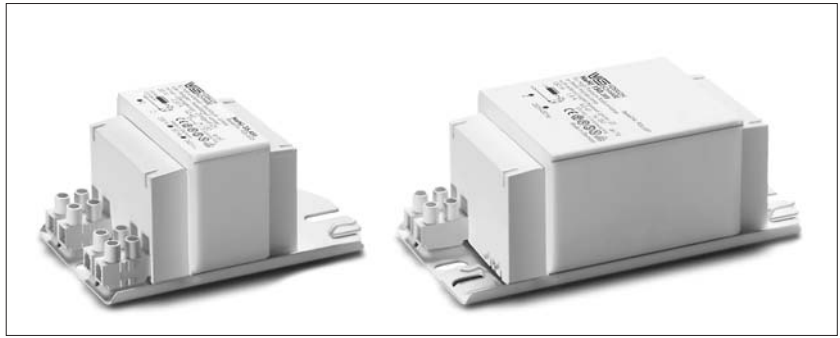

Lamp			Ballast										Capacitor	
Output W	Type	Current A	Type	Ref. No.	Voltage AC V, Hz	a mm	b mm	c mm	Weight kg	Δt K	Power factor λ	Energy efficiency*	C _p μF	I _N A
35	HS, HI	0.53	NaHJ 35.485	526517	220/230, 50	108	86	36	1.07	60	0.40	EEl=A3	6	0.22/0.21
35	HS, HI	0.53	NaHJ 35.485	161367	230/240, 50	108	86	36	1.07	60	0.40	EEl=A3	6	0.22/0.21
35	HS, HI	0.53	NaHJ 35.638	161371	220, 60	108	86	36	1.07	50	0.41	EEl=A3	5	0.23
50	HS, HI	0.76	NaH 50.486	161379	230/240, 50	108	86	36	1.07	65	0.37	EEl=A3	8	0.30/0.29
50	HS, HI	0.76	NaH 50.654	161399	220, 60	108	86	36	1.07	60	0.36	EEl=A3	8	0.31
50	HS, HI	0.76	NaHJ 70/50.157	160613	230, 50	108	86	42	1.23	55	0.37	EEl=A3	8	0.30
70	HS, HI	0.98			70					70	0.37	EEl=A3	12	0.38
70	HS, HI	0.98	NaHJ 70.300	174961	220, 50	108	86	36	1.07	75	0.40	EEl=A3	12	0.40
70	HS, HI	0.98	NaHJ 70.128	533568	230, 50	108	86	36	1.07	70	0.36	EEl=A3	12	0.38
70	HS, HI	0.98	NaHJ 70.128	539434	230/240, 50	108	86	36	1.07	70/75	0.36	EEl=A3	12	0.38/0.37
70	HS, HI	0.98	NaHJ 70.158	161662	240, 50	108	86	42	1.23	70	0.36	EEl=A3	12	0.37
70	HS, HI	0.98	NaHJ 70.128	538407	240, 50	108	86	36	1.07	75	0.37	EEl=A3	12	0.37
70	HS, HI	0.98	NaHJ 70.653	161392	220, 60	108	86	36	1.07	60	0.42	EEl=A3	10	0.40

* Step 2: EEl = A3, minimum EU energy efficiency requirements as of 2012 | Step 3: A2, minimum EU energy efficiency requirements as of 2017

Standard Ballasts for HS and HI Lamps 70 to 250 W

Shape: 53 x 66 mm

Lamp			Ballast										Capacitor	
Output W	Type	Current A	Type	Ref. No.	Voltage AC V, Hz	a mm	b mm	c mm	Weight kg	Δt K	Power factor λ	Energy efficiency*	C _p μF	I _N A
70	HS, HI	0.98	NaHJ 100/70.703	161469	230, 50	145	120	48	1.39	60	0.37	EEl=A3	12	0.38
100	HS, HI	1.20								70	0.43	EEl=A3	12	0.55
70	HS, HI	0.98	NaHJ 100/70.519	161158	230/240, 50	145	120	75	2.03	50	0.36	A2	12	0.38/0.37
100	HS, HI	1.20								60	0.42	EEl=A3	12	0.55/0.53
70	HS, HI	0.98	NaHJ 100/70.709	161471	220, 60	145	120	48	1.39	50	0.39	EEl=A3	10	0.40
100	HS, HI	1.20								60	0.44	EEl=A3	10	0.57
100	HS, HI	1.20	NaHJ 100.126	507671	220, 50	108	86	42	1.24	75	0.44	EEl=A3	12	0.55
100	HS, HI	1.20	NaHJ 100.941	161707	230/240, 50	108	86	42	1.24	75/80	0.42	EEl=A3	12	0.55/0.53
100	HS, HI	1.20	NaHJ 100.271	530195	220, 60	108	86	42	1.24	75	0.45	EEl=A3	10	0.57
150	HS, HI	1.80	NaHJ 150.159	533602	220, 50	145	120	64	1.80	75	0.41	EEl=A3	20	0.80
150	HS, HI	1.80	NaHJ 150.620	533565	230, 50	145	120	64	1.80	70	0.40	EEl=A3	20	0.77
150	HS, HI	1.80	NaHJ 150.620	534540	240, 50	145	120	64	1.80	75	0.40	EEl=A3	20	0.74
150	HS, HI	1.80	NaHJ 150.679	526196	220, 60	145	120	55	1.55	75	0.44	EEl=A3	16	0.80
150	HS, HI	1.80	NaHJ 150.679	537793	220, 60	117	92	55	1.55	75	0.44	EEl=A3	16	0.80
250	HS, HI	3.00	NaHJ 250.204	529087	220, 50	160	135	95	2.50	80	0.42	EEl=A3	32	1.32
250	HS, HI	3.00	NaHJ 250.160	160597	220, 50	180	155	110	2.84	75	0.41	EEl=A3	32	1.32
250	HS, HI	3.00	NaHJ 250.915	161686	230, 50	180	155	110	2.84	80	0.40	EEl=A3	32	1.26
250	HS, HI	3.00	NaHJ 250.340	504109	230/240, 50	180	155	110	2.84	80	0.39	EEl=A3	32	1.26/1.21
250	HS, HI	3.00	NaHJ 250.340	178177	240, 50	180	155	110	2.84	80	0.39	EEl=A3	32	1.21
250	HS, HI	3.00	NaHJ 250.163	529072	220, 60	160	135	95	2.50	70	0.42	A2	25	1.35
250	HS, HI	3.00	NaHJ 250.163	160604	220, 60	180	155	95	2.50	70	0.42	A2	25	1.35

* Step 2: EEl = A3, minimum EU energy efficiency requirements as of 2012 | Step 3: A2, minimum EU energy efficiency requirements as of 2017

Ballasts with Thermal Cut-out for HS and HI Lamps 35 to 150 W

Shape: 53x66 mm

For high pressure sodium lamps (HS), metal halide lamps (HI) and ceramic discharge lamps (C-HI)
 Vacuum-impregnated with polyester resin
 With VS-patented, intelligent temperature switch with automatic reset (evaluates the temperature and current of the ballast)
 Protection class I
 Iw 130
 Ballasts for pulse ignition system on request

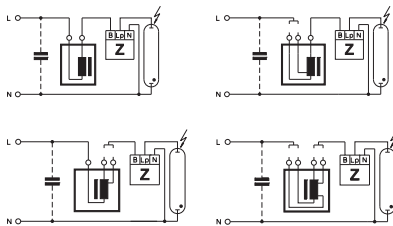

A Push-in terminals: 0.5-1.5 mm²

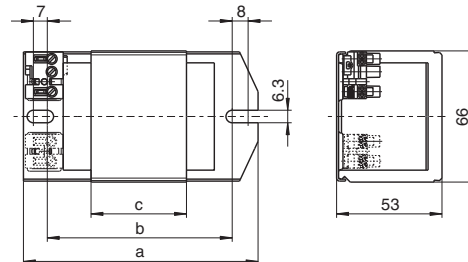

B Screw terminals: 0.5-2.5 mm²

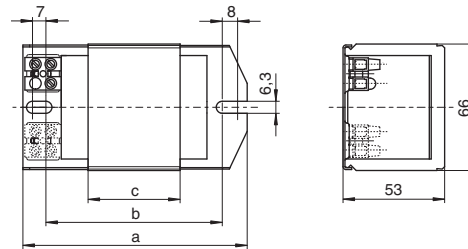

Lamp			Ballast										Capacitor		
Output W	Type	Current A	Type	Ref. No.	Voltage AC V, Hz	Drawing	a mm	b mm	c mm	Weight kg	Δt K	Power factor λ	Energy efficiency*	C _p μF	I _N A
Push-in terminals: 0.5-1.5 mm²															
35	HS, HI	0.53	NaHJ 35.209	543737	230/240, 50	A	108	86	36	1.07	35	0.36	A2	6	0.22
35	HS, HI	0.53	NaHJ 35.485	506122	230/240, 50	A	108	86	36	1.07	60	0.40	EEI=A3	6	0.22/0.21
35	HS, HI	0.53	NaHJ 35.638	509170	220, 60	A	108	86	36	1.07	50	0.41	EEI=A3	5	0.23
50	HS, HI	0.76	NaHJ 50.206	543738	230, 50	A	108	86	48	1.39	45	0.35	A2	8	0.30
50	HS, HI	0.76	NaHJ 70/50.157	507341	230, 50	A	108	86	42	1.23	55	0.37	EEI=A3	8	0.30
70	HS, HI	0.98			70						70	0.37	EEI=A3	12	0.38
50	HS, HI	0.76	NaHJ 70/50.520	538361	230, 50	A	117	92	48	1.39	45	0.36	EEI=A3	8	0.30
70	HS, HI	0.98			70						55	0.36	EEI=A3	12	0.38
70	HS, HI	0.98	NaHJ 70.128	535191	230, 50	A	108	86	36	1.07	70	0.36	EEI=A3	12	0.38
70	HS, HI	0.98	NaHJ 70.226	543741	230, 50	A	108	86	48	1.39	50	0.37	A2	12	0.38
70	HS, HI	0.98	NaHJ 70.128	533572	230/240, 50	A	108	86	36	1.07	70/75	0.36	EEI=A3	12	0.38/0.37
70	HS, HI	0.98	NaHJ 70.653	509169	220, 60	A	108	86	36	1.07	60	0.42	EEI=A3	10	0.40
70	HS, HI	0.98	NaHJ 100/70.703	507342	230, 50	A	145	120	48	1.39	60	0.37	EEI=A3	12	0.38
100	HS, HI	1.20			70						70	0.43	EEI=A3	12	0.55
100	HS, HI	1.20	NaHJ 100.213	554005	230/240, 50	B	117	92	55	1.55	60	0.41	A2	12	0.55/0.53
100	HS, HI	1.20	NaHJ 100.670	506120	230/240, 50	A	117	92	48	1.39	70	0.42	EEI=A3	12	0.55/0.53
100	HS, HI	1.20	NaHJ 100.941	539492	230/240, 50	A	108	86	42	1.23	75/80	0.42	EEI=A3	12	0.55/0.53
100	HS, HI	1.20	NaHJ 150/100.973	507343	230, 50	A	145	120	75	2.02	55	0.41	A2	12	0.55
150	HS, HI	1.80			75						75	0.41	EEI=A3	20	0.57
150	HS, HI	1.80	NaHJ 150.620	535216	230, 50	A	145	120	64	1.80	70	0.40	EEI=A3	20	0.77
150	HS, HI	1.80	NaHJ 150.620	538543	230/240, 50	A	145	120	64	1.80	70/75	0.40	EEI=A3	20	0.77/0.74
150	HS, HI	1.80	NaHJ 150.355	509100	230/240, 50	A	145	120	75	2.02	65	0.39	EEI=A3	20	0.77/0.74
150	HS, HI	1.80	NaHJ 150.679	509171	220, 60	A	145	120	75	2.02	65	0.42	EEI=A3	16	0.80

* Step 2: EEI = A3, minimum EU energy efficiency requirements as of 2012 | Step 3: A2, minimum EU energy efficiency requirements as of 2017

Ballasts with Thermal Cut-out for HS and HI Lamps 35 to 250 W

Shape: 53 x 66 mm

Lamp			Ballast											Capacitor	
Output W	Type	Current A	Type	Ref. No.	Voltage AC V, Hz	Drawing	a mm	b mm	c mm	Weight kg	Δt K	Power factor λ	Energy efficiency*	C _p μF	I _N A
Screw terminals: 0.5–2.5 mm²															
35	HS, HI	0.53	NaHJ 35.485	503010	230/240, 50	B	108	86	36	1.07	60	0.40	EEI=A3	6	0.22/0.21
35	HS, HI	0.53	NaH 50/35.797	539515	230, 50	B	108	86	36	1.07	45	0.40	EEI=A3	6	0.22
50	HS, HI	0.76									70	0.37	EEI=A3	8	0.30
50	HS, HI	0.76	NaH 50.486	507498	230/240, 50	B	108	86	36	1.07	65	0.37	EEI=A3	8	0.30
50	HS, HI	0.76	NaHJ 70/50.695	507697	230/240, 50	B	108	86	48	1.39	50	0.37	EEI=A3	8	0.30/0.29
70	HS, HI	0.98									70	0.37	EEI=A3	12	0.38/0.37
70	HS, HI	0.98	NaHJ 70.128	536582	230, 50	B	108	86	36	1.07	70	0.36	EEI=A3	12	0.38
70	HS, HI	0.98	NaHJ 70.158	169722	230/240, 50	B	108	86	42	1.23	70	0.36	EEI=A3	12	0.38/0.37
70	HS, HI	0.98	NaHJ 70.128	538830	230/240, 50	B	108	86	36	1.07	70/75	0.36	EEI=A3	12	0.38/0.37
70	HS, HI	0.98	NaHJ 70.158	546817	240, 50	B	108	86	42	1.23	70	0.36	EEI=A3	12	0.37
70	HS, HI	0.98	NaHJ 100/70.703	504131	230, 50	B	117	92	48	1.39	60	0.37	EEI=A3	12	0.38
100	HS, HI	1.20	NaHJ 100.941	543349	230, 50	B	108	86	42	1.23	75	0.42	EEI=A3	12	0.55
100	HS, HI	1.20									75/80	0.42	EEI=A3	12	0.55/0.53
100	HS, HI	1.20	NaHJ 150/100.973	504135	230, 50	B	145	120	75	2.02	55	0.41	A2	12	0.55
150	HS, HI	1.80	NaHJ 150.355	539270	220, 50	B	145	120	75	2.02	75	0.41	EEI=A3	20	0.77
150	HS, HI	1.80									65	0.39	EEI=A3	20	0.80
150	HS, HI	1.80	NaHJ 150.620	536593	230, 50	B	145	120	64	1.80	70	0.40	EEI=A3	20	0.77
150	HS, HI	1.80	NaHJ 150.995	169721	230/240, 50	B	145	120	75	2.02	70	0.40	EEI=A3	20	0.77/0.74
150	HS, HI	1.80	NaHJ 150.620	538831	230/240, 50	B	145	120	64	1.80	70/75	0.40	EEI=A3	20	0.77/0.74
150	HS, HI	1.80	NaHJ 150.620	537763	240, 50	B	130	105	64	1.80	75	0.40	EEI=A3	20	0.74
150	HS, HI	1.80	NaHJ 150.679	526616	220, 60	B	145	120	75	2.02	65	0.42	EEI=A3	16	0.80
250	HS, HI	3.00	NaHJ 250.915	505054	230, 50	B	180	155	110	2.84	80	0.40	EEI=A3	32	1.26
250	HS, HI	3.00	NaHJ 250.340	542349	230/240, 50	B	180	155	110	2.84	80	0.39	EEI=A3	32	1.26
250	HS, HI	3.00	NaHJ 250.340	508723	240, 50	B	180	155	110	2.84	80	0.39	EEI=A3	32	1.26

* Step 2: EEI = A3, minimum EU energy efficiency requirements as of 2012 | Step 3: A2, minimum EU energy efficiency requirements as of 2017

Compact Ballasts for HS and HI Lamps 35 to 150 W

Shape: 53 x 66 mm

For high pressure sodium lamps (HS),
metal halide lamps (HI) and
ceramic discharge lamps (C-HI)
Vacuum-impregnated with polyester resin
Push-in terminals: 0.5–1 mm²
IDC terminals for leads H05V-U 0.5
Protection class I
Ballasts with screw terminals on request

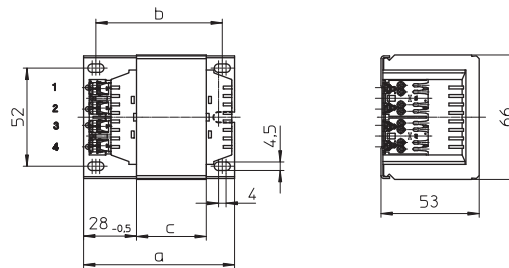
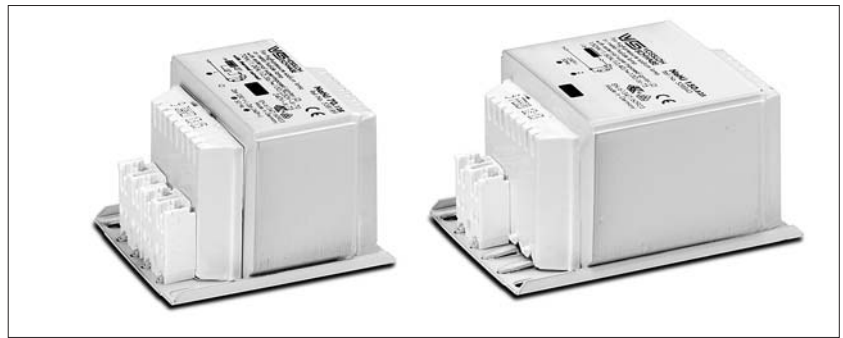
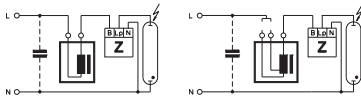

Lamp			Ballast											Capacitor	
Output W	Type	Current A	Type	Ref. No.	Voltage AC V, Hz	a mm	b mm	c mm	Weight kg	Δt K	t _w °C	Power factor λ	Energy efficiency*	C _p μF	I _N A
35	HS, HI	0.53	NaHJ 35.485	538807	230/240, 50	80	67	36	1.07	60	130	0.40	EEI=A3	6	0.22/0.21
70	HS, HI	0.98	NaHJ 70.128	538810	230, 50	80	67	36	1.07	70	130	0.36	EEI=A3	12	0.38
70	HS, HI	0.98	NaHJ 70.128	538823	230/240, 50	80	67	36	1.07	70/75	130	0.36	EEI=A3	12	0.38/0.37
70	HS, HI	0.98	NaHJ 70.653	538828	220, 60	80	67	36	1.07	60	130	0.42	EEI=A3	10	0.40
150	HS, HI	1.80	NaHJ 150.620	538834	230, 50	107	94	64	1.80	70	130	0.40	EEI=A3	20	0.77
150	HS, HI	1.80	NaHJ 150.625	538843	240, 50	107	94	64	1.80	75	130	0.40	EEI=A3	20	0.74
150	HS, HI	1.80	NaHJ 150.679	542557	220, 60	107	94	64	1.80	75	130	0.44	EEI=A3	16	0.80

* Step 2: EEI = A3, minimum EU energy efficiency requirements as of 2012 | Step 3: A2, minimum EU energy efficiency requirements as of 2017

With Thermal Cut-out

Thermal cut-out with automatic reset

Lamp			Ballast											Capacitor	
Output W	Type	Current A	Type	Ref. No.	Voltage AC V, Hz	a mm	b mm	c mm	Weight kg	Δt K	t _w °C	Power factor λ	Energy efficiency*	C _p μF	I _N A
35	HS, HI	0.53	NaHJ 35.485	538258	230/240, 50	80	67	36	1.07	60	130	0.40	EEI=A3	6	0.22/0.21
70	HS, HI	0.98	NaHJ 70.128	538189	230/240, 50	80	67	36	1.07	70/75	130	0.36	EEI=A3	12	0.38/0.37
70	HS, HI	0.98	NaHJ 70.128	539223	230/240, 50	80	67	36	1.07	70/75	140	0.36	EEI=A3	12	0.38/0.37
70	HS, HI	0.98	NaHJ 70.653	538537	220, 60	80	67	36	1.07	60	130	0.42	EEI=A3	10	0.40
100	HS, HI	1.20	NaHJ 100.581	539081	230/240, 50	107	94	64	1.80	60	130	0.42	EEI=A3	12	0.55/0.53
150	HS, HI	1.80	NaHJ 150.159	548260	220, 50	107	94	64	1.80	75	130	0.41	EEI=A3	20	0.77
150	HS, HI	1.80	NaHJ 150.620	538262	230, 50	107	94	64	1.80	70	130	0.40	EEI=A3	20	0.77
150	HS, HI	1.80	NaHJ 150.620	539306	230, 50	107	94	64	1.80	70	140	0.40	EEI=A3	20	0.77
150	HS, HI	1.80	NaHJ 150.620	538264	240, 50	107	94	64	1.80	75	130	0.40	EEI=A3	20	0.74
150	HS, HI	1.80	NaHJ 150.620	539286	240, 50	107	94	64	1.80	75	140	0.40	EEI=A3	20	0.74
150	HS, HI	1.80	NaHJ 150.679	539311	220, 60	107	94	64	1.80	75	130	0.44	EEI=A3	16	0.80

* Step 2: EEI = A3, minimum EU energy efficiency requirements as of 2012 | Step 3: A2, minimum EU energy efficiency requirements as of 2017

Ballasts with Thermal Cut-out for HS and HI Lamps 35 to 150 W, Protection Class II



Encapsulated ballast in compact plastic casing
Shape: 61 x 72 mm

For high pressure sodium lamps (HS), metal halide lamps (HI) and ceramic discharge lamps (C-HI)
 With cable holder
 Thermal cut-out with automatic reset
 Screw terminals: 0,5-2,5 mm²

Protection class II
 tw 130

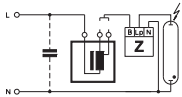
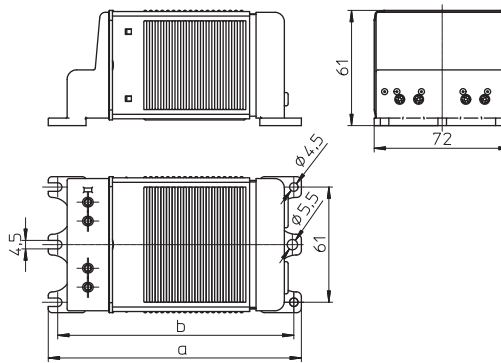

Lamp			Ballast									Capacitor	
Output W	Type	Current A	Type	Ref. No.	Voltage AC V, Hz	a mm	b mm	Weight kg	Δt K	Power factor λ	Energy efficiency*	C _p μ F	I _N A
35	HS, HI	0.53	NaHZ 50/35.797	539609	230, 50	134	125	1.60	45	0.40	EEl=A3	6	0.22
50	HS, HI	0.76							70	0.37	EEl=A3	8	0.30
50	HS, HI	0.76	NaHJZ 70/50.520	533395	230, 50	134	125	1.60	45	0.36	EEl=A3	8	0.30
70	HS, HI	0.98							65	0.36	EEl=A3	12	0.38
70	HS, HI	0.98	NaHJZ 100/70.519	533396	230, 50	161	152	2.10	45	0.36	EEl=A3	12	0.38
100	HS, HI	1.20							60	0.42	EEl=A3	12	0.55
100	HS, HI	1.20	NaHJZ 150/100.466	533398	230, 50	161	152	2.30	45	0.41	A2	12	0.85
150	HS, HI	1.80							70	0.39	EEl=A3	20	0.77

* Step 2: EEl = A3, minimum EU energy efficiency requirements as of 2012 | Step 3: A2, minimum EU energy efficiency requirements as of 2017

Ballasts with Thermal Cut-out and Thermal Fuse for HS and HI Lamps 35 to 150 W, Protection Class II

With double insulation
Shape: 53 x 66 mm

For high pressure sodium lamps (HS), metal halide lamps (HI) and ceramic discharge lamps (C-HI)
Thermal cut-out with automatic reset
Screw terminals: 0.5-2.5 mm²

Protection class II

tw 130

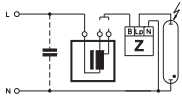
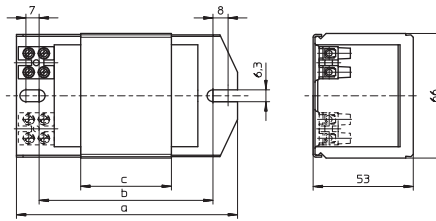
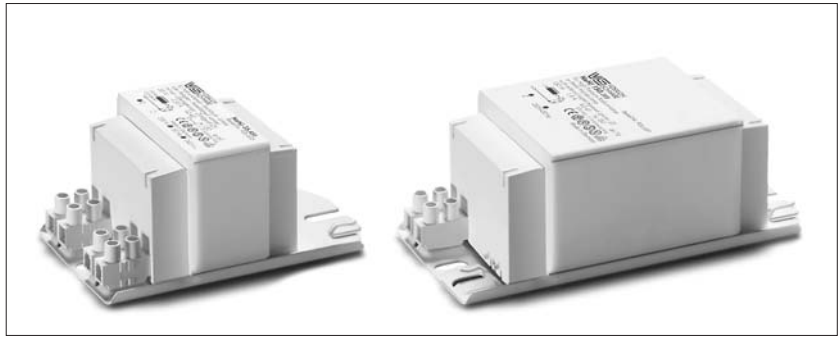

Lamp			Ballast										Capacitor	
Output W	Type	Current A	Type	Ref. No.	Voltage AC V, Hz	a mm	b mm	c mm	Weight kg	Δt K	Power factor λ	Energy efficiency*	C _p μF	I _N A
35	HS, HI	0.53	NaHZ 50/35.797	553806	230, 50	108	92	36	1.07	45	0.40	EEI=A3	6	0.22
	50	HS, HI											0.76	8
50	HS, HI	0.76	NaHJZ 70/50.785	509490	230, 50	108	92	42	1.24	50	0.35	A2	8	0.30
	70	HS, HI											0.98	12
70	HS, HI	0.98	NaHJZ 100/70.786	509491	230, 50	145	120	69	1.83	55	0.38	EEI=A3	12	0.38
	100	HS, HI											1.20	12
100	HS, HI	1.20	NaHJZ 150/100.787	509492	230, 50	145	120	69	1.83	50	0.39	EEI=A3	12	0.85
	150	HS, HI											1.80	20

* Step 2: EEI = A3, minimum EU energy efficiency requirements as of 2012 | Step 3: A2, minimum EU energy efficiency requirements as of 2017

- 1
- 2
- 3
- 4
- 5
- 6
- 7
- 8
- 9
- 10

Ballasts for HS and HI Lamps 150 to 400 W

Shape: 71x75 mm

For high pressure sodium lamps (HS), metal halide lamps (HI) and ceramic discharge lamps (C-HI)
 Vacuum-impregnated with polyester resin
 Screw terminals: 0.75-2.5 mm²
 Protection class I
 tw 130
 Ballasts for pulse ignition system on request

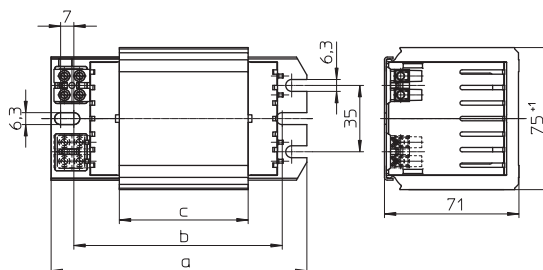
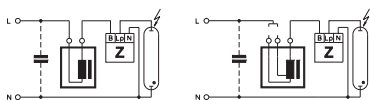

Lamp			Ballast										Capacitor	
Output W	Type	Current A	Type	Ref. No.	Voltage AC V, Hz	a mm	b mm	c mm	Weight kg	Δt K	Power factor λ	Energy efficiency*	C _p μF	I _N A
250	HS, HI	3.00	NaHJ 250.741	536147	220, 50	135	115	68	2.85	70	0.42	A2	32	1.35
250	HS, HI	3.00	NaHJ 250.741	536148	230, 50	135	115	68	2.85	75	0.40	A2	32	1.30
250	HS, HI	3.00	NaHJ 250.741	536149	240, 50	135	115	68	2.85	75	0.39	A2	32	1.25
250	HS, HI	3.00	NaHJ 250.742	536150	220, 60	135	115	68	2.85	70	0.42	A2	25	1.40
400	HS, HI	4.45	NaHJ 400.743	536142	220, 50	165	145	103	4.1	70	0.45	A2	45	2.10
400	HS, HI	4.45	NaHJ 400.743	535142	230, 50	165	145	103	4.1	75	0.44	A2	45	2.00
400	HS, HI	4.45	NaHJ 400.743	536143	240, 50	165	145	103	4.1	75	0.40	A2	45	1.85
400	HS, HI	4.45	NaHJ 400.744	536144	220, 60	165	145	103	4.1	70	0.44	A2	40	2.05

* Step 2: EEI = A3, minimum EU energy efficiency requirements as of 2012 | Step 3: A2, minimum EU energy efficiency requirements as of 2017

With Thermal Cut-out

Thermal cut-out with automatic reset

Lamp			Ballast										Capacitor	
Output W	Type	Current A	Type	Ref. No.	Voltage AC V, Hz	a mm	b mm	c mm	Weight kg	Δt K	Power factor λ	Energy efficiency*	C _p μF	I _N A
150	HS, HI	1.80	NaHJ 150.216	543740	230, 50	135	115	68	2.85	45	0.40	A2	20	0.77
250	HS, HI	3.00	NaHJ 250.741	539274	220, 50	135	115	68	2.85	70	0.42	A2	32	1.35
250	HS, HI	3.00	NaHJ 250.741	544210	230, 50	135	115	68	2.85	65	0.40	A2	32	1.30
250	HS, HI	3.00	NaHJ 250.741	536151	230, 50	135	115	68	2.85	75	0.40	A2	32	1.30
250	HS, HI	3.00	NaHJ 250.741	537726	230/240, 50	135	115	68	2.85	75	0.40	A2	32	1.30/1.25
250	HS, HI	3.00	NaHJ 250.741	536152	240, 50	135	115	68	2.85	75	0.39	A2	32	1.25
400	HS, HI	4.45	NaHJ 400.743	548259	220, 50	165	145	103	4.1	70	0.44	A2	45	2.10
400	HS, HI	4.45	NaHJ 400.743	536145	230, 50	165	145	103	4.1	75	0.44	A2	45	2.00
400	HS, HI	4.45	NaHJ 400.743	538204	230, 50	165	145	103	4.1	65	0.41	A2	45	2.00
400	HS, HI	4.45	NaHJ 400.743	539209	230/240, 50	165	145	103	4.1	75	0.41	A2	45	2.00/1.85
400	HS, HI	4.45	NaHJ 400.743	543986	240, 50	165	145	103	4.1	70	0.40	A2	45	1.85
400	HS, HI	4.45	NaHJ 400.743	536146	240, 50	165	145	103	4.1	75	0.40	A2	45	1.85
400	HS, HI	4.45	NaHJ 400.744	538620	220, 60	165	145	103	4.1	70	0.44	A2	40	2.05

* Step 2: EEI = A3, minimum EU energy efficiency requirements as of 2012 | Step 3: A2, minimum EU energy efficiency requirements as of 2017

Ballasts for HS and HI Lamps 250 to 600 W

Shape: 92 x 102 mm

For high pressure sodium lamps (HS), metal halide lamps (HI) and ceramic discharge lamps (C-HI)

Vacuum-impregnated with polyester resin

Screw terminals: 0.75-2.5 mm²

Protection class I

tw 130

Ballasts for pulse ignition system on request

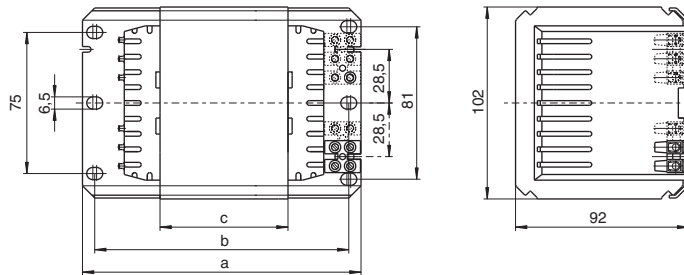
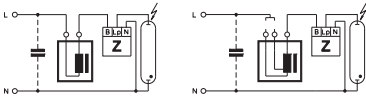

Lamp			Ballast										Capacitor	
Output W	Type	Current A	Type	Ref. No.	Voltage AC V, Hz	a mm	b mm	c mm	Weight kg	Δt K	Power factor λ	Energy efficiency*	C _p μF	I _N A
250	HS, HI	3.00	NaHJ 250.003	179743	220, 50	133	120	44	3.53	70	0.41	EEI=A3	32	1.32
250	HS, HI	3.00	NaHJ 250.727	178771	230, 50	133	120	44	3.53	70	0.39	EEI=A3	32	1.26
250	HS, HI	3.00	NaHJ 250.727	500976	240, 50	133	120	44	3.53	70	0.39	EEI=A3	32	1.21
250	HS, HI	3.00	NaHJ 250.011	500401	220, 60	133	120	44	3.53	65	0.43	A2	25	1.35
400	HS, HI	4.45	NaHJ 400.006	179740	220, 50	148	135	68	5.20	70	0.44	A2	45	2.00
400	HS, HI	4.45	NaHJ 400.006	178790	230, 50	148	135	68	5.20	70	0.44	A2	45	1.95
400	HS, HI	4.45	NaHJ 400.737	500402	240, 50	148	135	68	5.20	75	0.43	A2	45	1.90
400	HS, HI	4.45	NaHJ 400.012	500403	220, 60	148	135	68	5.20	70	0.44	A2	40	2.00
400	HI	3.50	J 400.027	505782	230/240, 50	148	135	68	5.20	60	0.45	A2	35	1.64/1.59
600	HS	6.20	NaH 600.010	179742	220, 50	173	160	96	6.80	70	0.44	A2	65	2.90
600	HS	6.20	NaH 600.005	533484	230/240, 50	173	160	96	6.80	70	0.44	A2	65	2.90/2.85
600	HS	6.20	NaH 600.140	529560	220, 60	173	160	96	6.80	65	0.46	A2	55	3.00

* Step 2: EEI = A3, minimum EU energy efficiency requirements as of 2012 | Step 3: A2, minimum EU energy efficiency requirements as of 2017

With Thermal Cut-out

Thermal cut-out with automatic reset

Lamp			Ballast										Capacitor	
Output W	Type	Current A	Type	Ref. No.	Voltage AC V, Hz	a mm	b mm	c mm	Weight kg	Δt K	Power factor λ	Energy efficiency*	C _p μF	I _N A
250	HS, HI	3.00	NaHJ 250.727	500969	230/240, 50	133	120	44	3.53	70	0.39	EEI=A3	32	1.26/1.21
250	HS, HI	3.00	NaHJ 250.011	508744	220, 60	133	120	44	3.46	65	0.43	A2	25	1.35
400	HS, HI	4.45	NaHJ 400.737	179424	230/240, 50	148	135	68	5.20	70/75	0.43	A2	45	1.95/1.90
400	HI	3.50	J 400.027	509613	230/240, 50	148	135	68	5.20	60	0.45	A2	35	1.64/1.59
400	HS, HI	4.45	NaHJ 400.012	508741	220, 60	148	135	68	5.20	70	0.44	A2	40	2.00
600	HS	6.20	NaH 600.005	179454	230/240, 50	173	160	96	6.80	70	0.44	A2	65	2.90/2.85

* Step 2: EEI = A3, minimum EU energy efficiency requirements as of 2012 | Step 3: A2, minimum EU energy efficiency requirements as of 2017

Ballasts for HS and HI Lamps 1000 W

Shape: 92 x 102 mm

For high pressure sodium lamps (HS)
and metal halide lamps (HI)
Vacuum-impregnated with polyester resin
Screw terminals: 0.75-2.5 mm²
Protection class I
tw 130
Ballasts for pulse ignition system on request

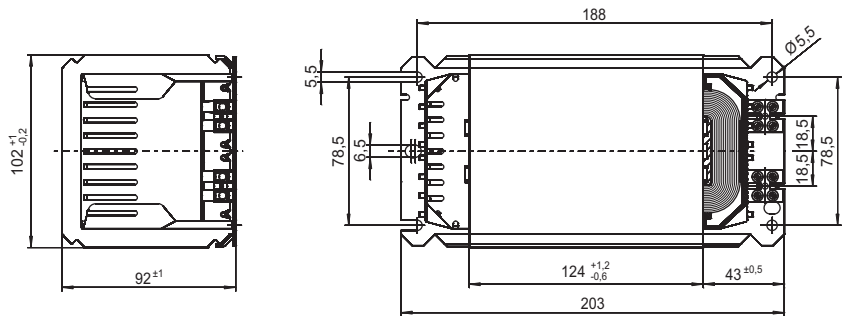
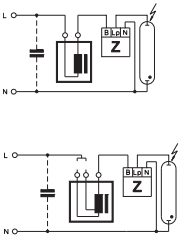

Lamp			Ballast											Capacitor	
Output W	Type	Current A	Type	Ref. No.	Voltage AC V, Hz	a mm	b mm	c mm	Weight kg	Δt K	Power factor λ	Energy efficiency*	C _P μF	I _N A	
1000	HS	10.30	NaHJ 1000.089	534487	220, 50	203	188	124	8.90	80	0.47	A2	100	5.1	
	HI	9.50									0.51				85
1000	HS	10.30	NaHJ 1000.089	539212	220/230, 50	203	188	124	8.90	80	0.45	A2	100	5.1	
	HI	9.50									0.49				85
1000	HS	10.30	NaHJ 1000.089	528548	230, 50	203	188	124	8.90	80	0.45	A2	100	5.1	
	HI	9.50									0.49				85
1000	HS	10.30	NaHJ 1000.089	544787	230/240, 50	203	188	124	8.90	85	0.45	A2	100	5.1	
	HI	9.50									0.46				85
1000	HS	10.30	NaHJ 1000.089	536140	240, 50	203	188	124	8.90	85	0.42	A2	100	4.8	
	HI	9.50									0.46				85
1000	HS	10.30	NaHJ 1000.089	528536	220, 60	203	188	124	8.90	75	0.46	A2	100	5.1	
	HI	9.50									0.50				85

* Step 2: EEI = A3, minimum EU energy efficiency requirements as of 2012 | Step 3: A2, minimum EU energy efficiency requirements as of 2017

Ballasts for HI Lamps up to 2500 W

Shape: 150x150 mm

For metal halide lamps (HI)
 Vacuum impregnated with polyester resin
 Screw terminals: 0.75-4 mm²
 For luminaires of protection class I
 tw 130

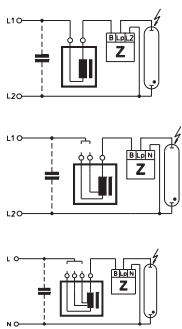

For Short Arc Lamps

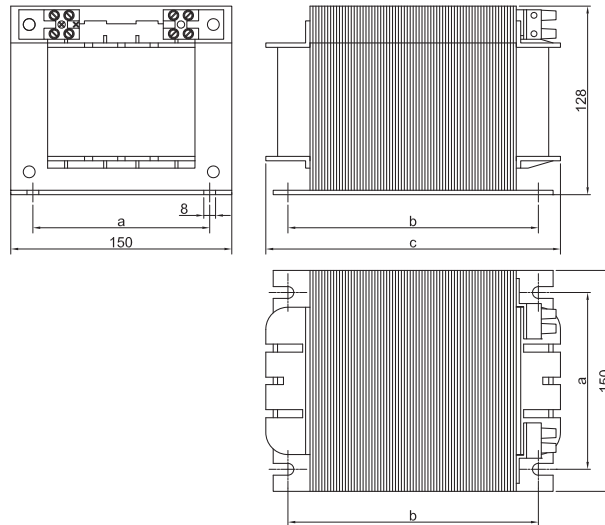

Lamp			Ballast										Capacitor	
Output W	Type	Current A	Type	Ref. No.	Voltage AC V, Hz	a mm	b mm	c mm	Weight kg	Δt K	Power factor λ	Energy efficiency*	C _p μF	I _N A
2000	HI	8.8	J 2000.71	554303	380/400, 50	122	175	200	15	75	0.60	A2	37	6
2000	HI	8.8	J 2000.72	554304	380/400/415, 50	122	135	160	14	70	0.58	A2	37	6
2000	HI	8.8	J 2000.73	554305	380, 60	122	175	200	15	75	0.53	A2	30	6
2000	HI	10.3/11.3	JD 2000.81	554270	380/400, 50	122	175	200	15	80	0.53	A2	60	6
2000	HI	10.3/11.3	JD 2000.81	554306	380/400/415, 50	122	135	160	14	75	0.52	A2	60	6
2000	HI	10.3/11.3	JD 2000.83	554283	380, 60	122	175	200	15	75	0.54	A2	50	6
2000	HI	12.2	JD 2000II.91	554307	380/400, 50	122	175	200	16	80	0.46	A2	70	6
2000	HI	12.2	JD 2000II.92	554308	380, 60	122	175	200	16	75	0.45	A2	60	6
2000	HI	16.5	JD 2000I.85	554309	230/240, 50	122	135	160	14	80	0.57	A2	125	10.5
2000	HI	16.5	JD 2000I.86	554310	220, 60	122	135	160	14	80	0.57	A2	105	10
For Short Arc Lamps 1200 and 2500 W														
1200	HI	13.8	J 1200.95	554311	208, 60 230/245, 50	122	105	130	11	-	0.40	A2 A2	150	6
2500	HI	25.6	J 2500.96	554312	208, 60 230/245, 50	122	175	200	16	-	0.44	A2 A2	260	12.3

* Step 2: EEI = A3, minimum EU energy efficiency requirements as of 2012 | Step 3: A2, minimum EU energy efficiency requirements as of 2017

Ballasts for HM and HI Lamps 50 to 400 W

Shape: 53 x 66 mm

For mercury vapour lamps (HM) and
metal halide lamps (HI) with ignition voltage 1 kV

Vacuum-impregnated with polyester resin

Screw terminals: 0.5-2.5 mm²

Protection class I

tw 130

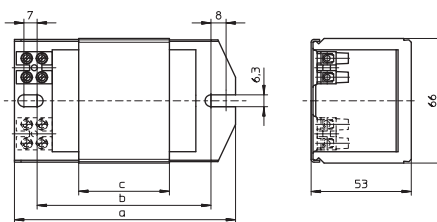
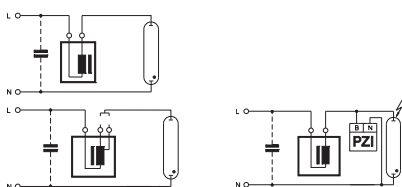

Lamp			Ballast										Capacitor	
Output W	Type	Current A	Type	Ref. No.	Voltage AC V, Hz	a mm	b mm	c mm	Weight kg	Δt K	Power factor λ	Energy efficiency*	C _p μF	I _N A
50	HM	0.61	Q 50.501	167100	220, 50	108	86	36	1.07	55	0.44	EEl=A3	7	0.28
50	HM	0.61	Q 50.550	167213	230, 50	108	86	36	1.07	55	0.44	EEl=A3	7	0.27
50	HM	0.61	Q 50.508	167125	240, 50	108	86	36	1.07	65	0.42	EEl=A3	7	0.26
50	HM	0.61	Q 50.535	167185	220, 60	108	86	36	1.07	50	0.44	EEl=A3	6	0.28
50	HM	0.61	Q 80/50.596	167311	230, 50	108	86	36	1.07	55	0.43	EEl=A3	7	0.27
80	HM	0.80								70	0.51	EEl=A3	8	0.41
50	HM	0.61	Q 80/50.592	167306	220, 60	108	86	36	1.07	50	0.44	EEl=A3	6	0.28
80	HM	0.80								60	0.53	EEl=A3	7	0.43
80	HM	0.80	Q 80.587	167302	220, 50	108	86	36	1.07	65	0.52	EEl=A3	8	0.43
80	HM	0.80	Q 80.588	167304	230, 50	108	86	36	1.07	70	0.51	EEl=A3	8	0.41
80	HM	0.80	Q 80.510	167132	240, 50	108	86	36	1.07	60	0.48	EEl=A3	8	0.40
80	HM	0.80	Q 80.584	167299	220, 60	108	86	36	1.07	55	0.51	EEl=A3	7	0.43
80	HM	0.80	Q 125/80.611	167326	230, 50	108	86	42	1.23	50	0.49	EEl=A3	8	0.41
125	HM	1.15								70	0.54	EEl=A3	10	0.60
80	HM	0.80	Q 125/80.511	167136	240, 50	108	86	48	1.39	50	0.48	EEl=A3	8	0.40
125	HM	1.15								70	0.52	EEl=A3	10	0.58
125	HM	1.15	Q 125.549	169947	220, 50	108	86	36	1.07	70	0.56	EEl=A3	10	0.63
125	HM	1.15	Q 125.568	167263	230, 50	108	86	36	1.07	75	0.54	EEl=A3	10	0.60
125	HM	1.15	Q 125.512	167140	240, 50	108	86	48	1.39	65	0.51	EEl=A3	10	0.58
125	HM	1.15	Q 125.598	502818	220, 60	108	86	36	1.07	60	0.57	EEl=A3	10	0.65
250	HM	2.13	Q 250.513	167144**	220, 50	145	120	75	2.10	75	0.58	EEl=A3	18	1.26
250	HM	2.13	Q 250.528	167367**	230, 50	145	120	75	2.10	75	0.56	EEl=A3	18	1.20
250	HM	2.13	Q 250.703	507256**	240, 50	145	120	75	2.10	75	0.53	EEl=A3	18	1.15
250	HM	2.13	Q 250.606	533705**	220, 60	145	120	64	1.80	70	0.58	A2	15	1.30
400	HM	3.25	Q 400.616	528236**	220, 50	160	135	95	2.50	80	0.60	EEl=A3	25	2.00
400	HM	3.25	Q 400.561	167250**	220, 50	180	155	110	2.88	75	0.60	A2	25	2.00
400	HM	3.25	Q 400.612	167330**	230, 50	180	155	110	2.88	75	0.56	EEl=A3	25	1.90
400	HM	3.25	Q 400.669	167374**	240, 50	180	155	110	2.88	75	0.54	EEl=A3	25	1.85
400	HM	3.25	Q 400.613	167335**	220, 60	180	155	110	2.88	65	0.60	EEl=A3	25	2.00
400	HM	3.25	Q 400.613	508245**	220, 60	180	155	95	2.50	75	0.60	EEl=A3	25	2.00

* Step 2: EEl = A3, minimum EU energy efficiency requirements as of 2012 | Step 3: A2, minimum EU energy efficiency requirements as of 2017

** Suitable for metal halide lamps (HI) with ignition voltage 1 kV in combination with pulse ignitor PZI 1000/1 K (see page 54)

Ballasts for HM and HI Lamps 250 and 400 W

Shape: 71x75 mm

For mercury vapour lamps (HM) and metal halide lamps (HI) with ignition voltage 1 kV
 Vacuum-impregnated with polyester resin
 Screw terminals: 0.75-2.5 mm²
 Protection class I
 tw 130

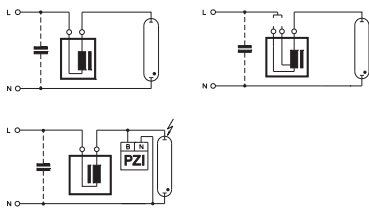
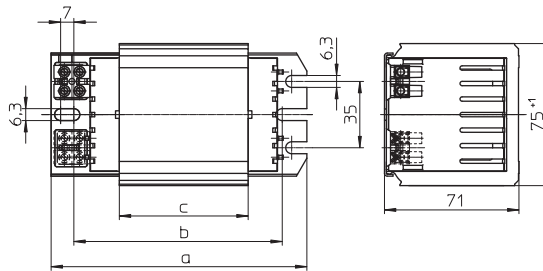

Lamp			Ballast										Capacitor	
Output W	Type	Current A	Type	Ref. No.	Voltage AC V, Hz	a mm	b mm	c mm	Weight kg	Δt K	Power factor λ	Energy efficiency*	C _p μF	I _N A
250	HM	2.13	Q 250.800	536260**	230/240, 50	135	115	68	2.85	55	0.53	EEI=A3	18	1.3
400	HM	3.25	Q 400.715	537869**	220, 50	135	115	68	2.85	70	0.59	A2	25	2.0
400	HM	3.25	Q 400.801	536258**	230, 50	135	115	68	2.85	75	0.58	EEI=A3	25	2.0
400	HM	3.25	Q 400.801	538034**	230, 50	135	115	68	2.85	65	0.58	EEI=A3	25	2.0
400	HM	3.25	Q 400.801	537703**	230/240, 50	135	115	68	2.85	75	0.58	EEI=A3	25	2.0/1.85
400	HM	3.25	Q 400.732	537873**	220, 60	135	115	68	2.85	70	0.59	A2	25	2.0

* Step 2: EEI = A3, minimum EU energy efficiency requirements as of 2012 | Step 3: A2, minimum EU energy efficiency requirements as of 2017

** Suitable for metal halide lamps (HI) with ignition voltage 1 kV in combination with pulse ignitor PZI 1000/1 K (see page 54)

With Thermal Cut-out

Thermal cut-out with automatic reset

Lamp			Ballast										Capacitor	
Output W	Type	Current A	Type	Ref. No.	Voltage AC V, Hz	a mm	b mm	c mm	Weight kg	Δt K	Power factor λ	Energy efficiency*	C _p μF	I _N A
250	HM	2.13	Q 250.800	536261**	230/240, 50	135	115	68	2.85	55	0.53	EEI=A3	18	1.3
400	HM	3.25	Q 400.801	536259**	230, 50	135	115	68	2.85	75	0.58	EEI=A3	25	2.0

* Step 2: EEI = A3, minimum EU energy efficiency requirements as of 2012 | Step 3: A2, minimum EU energy efficiency requirements as of 2017

** Suitable for metal halide lamps (HI) with ignition voltage 1 kV in combination with pulse ignitor PZI 1000/1 K (see page 54)

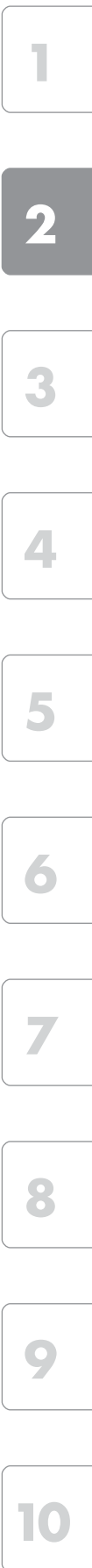

Ballasts for HM and HI Lamps 250 to 1000 W

Shape: 92 x 102 mm

For mercury vapour lamps (HM) and metal halide lamps (HI) with ignition voltage 1 kV
Vacuum-impregnated with polyester resin
Screw terminals: 0.75-2.5 mm²

Protection class I
tw 130

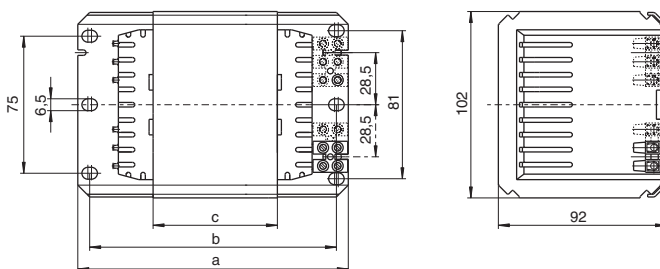
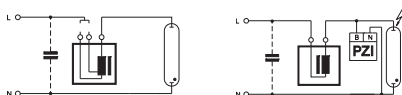
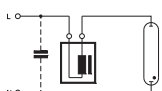

Lamp			Ballast										Capacitor	
Output W	Type	Current A	Type	Ref. No.	Voltage AC V, Hz	a mm	b mm	c mm	Weight kg	Δt K	Power factor λ	Energy efficiency*	C _P μF	I _N A
250	HM	2.13	Q 250.417	504467 **	230/240, 50	133	120	44	3.53	50	0.52	EEI=A3	18	1.20
400	HM	3.25	Q 400.001	504474 **	230/240, 50	133	120	44	3.53	65	0.56	EEI=A3	25	1.80
700	HM	5.40	Q 700.035	528521	230/240, 50	173	160	96	6.90	60	0.56	EEI=A3	40	3.40
1000	HM	7.50	Q 1000.097	537103 **	220, 50	173	160	96	6.90	75	0.61	EEI=A3	60	4.80
1000	HM	7.50	Q 1000.096	538540 **	230, 50	173	160	96	6.90	65	0.60	EEI=A3	60	4.80
1000	HM	7.50	Q 1000.096	528761 **	230, 50	173	160	96	6.90	65	0.60	EEI=A3	60	4.80
1000	HM	7.50	Q 1000.145	528886 **	240, 50	173	160	96	6.90	75	0.58	EEI=A3	60	4.60
1000	HM	7.50	Q 1000.311	526715 **	220, 60	173	160	96	6.90	70	0.61	EEI=A3	50	5.00

* Step 2: EEI = A3, minimum EU energy efficiency requirements as of 2012 | Step 3: A2, minimum EU energy efficiency requirements as of 2017

** Suitable for metal halide lamps (HI) with ignition voltage 1 kV in combination with pulse ignitor PZI 1000/1 K (see page 54)

With Thermal Cut-out

Thermal cut-out with automatic reset

Lamp			Ballast										Capacitor	
Output W	Type	Current A	Type	Ref. No.	Voltage AC V, Hz	a mm	b mm	c mm	Weight kg	Δt K	Power factor λ	Energy efficiency*	C _P μF	I _N A
250	HM	2.13	Q 250.417	508746 **	230/240, 50	133	120	44	3.53	50	0.52	EEI=A3	18	1.20
400	HM	3.25	Q 400.001	505002 **	230/240, 50	133	120	44	3.53	65	0.56	EEI=A3	25	1.80

* Step 2: EEI = A3, minimum EU energy efficiency requirements as of 2012 | Step 3: A2, minimum EU energy efficiency requirements as of 2017

** Suitable for metal halide lamps (HI) with ignition voltage 1 kV in combination with pulse ignitor PZI 1000/1 K (see page 54)

Compact Power Reduction Kits for HS Lamps 50 to 150 W

Ballast shape: 53 x 66 mm

For high pressure sodium lamps (HS)
Compact power reduction kit with ballast with or without patented, intelligent thermal cut-out with automatic reset (which evaluates the temperature and current of the ballast), ignitor, power switch and compensation capacitor

With luminaire terminal block:
screw terminal 0.75-2.5 mm²

With earth terminal

Permissible load capacity: 20-100 pF

Lead length to the lamp: max. 1.5 m

tw 130

Further outputs and voltages on request

With digital timer ignitor on request

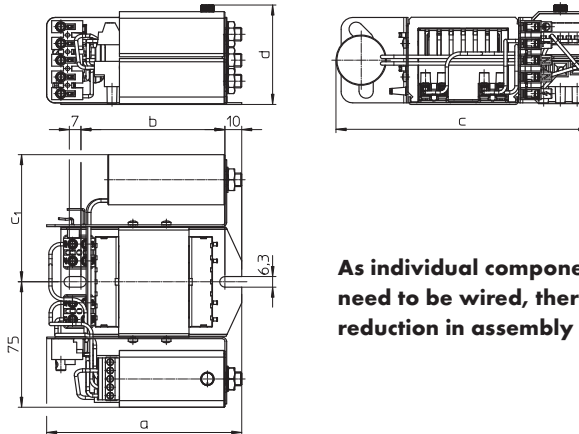
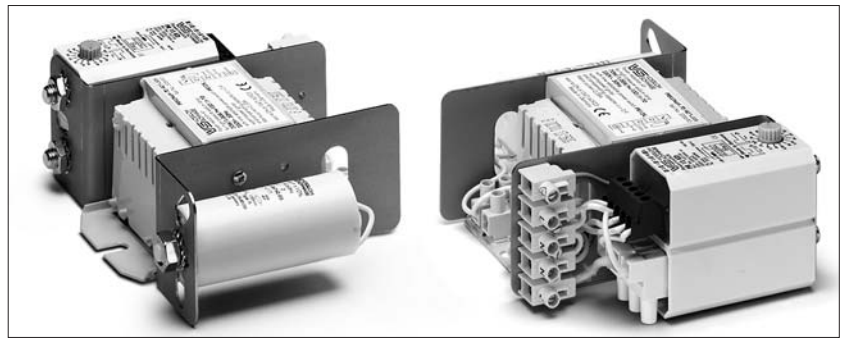

As individual components no longer need to be wired, there is a significant reduction in assembly time and costs.

Lamp			Power reduction kit													
Output	Type	Current	Type	Ref. No.	Voltage AC V, Hz	Mains current A	Temperature protection	a mm	b mm	c mm	c1 mm	d mm	Weight kg	Power factor λ	Energy efficiency*	
Power reduction without control phase – Intelligent power switch PR 12 K LC (Light Control)																
70/40%	HS	0.98	PRKUNaH 70/40%.525	543384	220, 50	0.38	no	117	86	151	76	60	1.5	> 0.90	EEL=A3	
100/40%	HS	1.20	PRKUNaH 100/40%.522	543388	220, 50	0.56	no	123	92	151	76	60	1.7	> 0.90	EEL=A3	
150/40%	HS	1.80	PRKUNaH 150/40%.142	543385	220, 50	0.77	no	151	120	154	79	60	2.3	> 0.90	EEL=A3	
50/40%	HS	0.76	PRKUNaH 50/40%.021	544760	230, 50	0.30	yes	117	86	151	76	56	1.5	> 0.90	EEL=A3	
70/40%	HS	0.98	PRKUNaH 70/40%.525	543742	230, 50	0.38	yes	117	86	151	76	60	1.5	> 0.90	EEL=A3	
100/40%	HS	1.20	PRKUNaH 100/40%.522	543743	230, 50	0.55	yes	123	92	151	76	60	1.7	> 0.90	EEL=A3	
150/40%	HS	1.80	PRKUNaH 150/40%.142	543744	230, 50	0.77	yes	151	120	154	79	60	2.3	> 0.90	EEL=A3	
Power reduction without control phase – Power switch PR 12 KD with selectable switching time																
70/40%	HS	0.98	PRKUNaH 70/40%.525	539328	220, 50	0.38	no	117	86	151	76	60	1.5	> 0.90	EEL=A3	
100/40%	HS	1.20	PRKUNaH 100/40%.522	539330	220, 50	0.56	no	123	92	151	76	60	1.7	> 0.90	EEL=A3	
150/40%	HS	1.80	PRKUNaH 150/40%.142	539332	220, 50	0.77	no	151	120	154	79	60	2.3	> 0.90	EEL=A3	
70/40%	HS	0.98	PRKUNaH 70/40%.525	538690	230, 50	0.38	yes	117	86	151	76	60	1.5	> 0.90	EEL=A3	
100/40%	HS	1.20	PRKUNaH 100/40%.522	538691	230, 50	0.56	yes	123	92	151	76	60	1.7	> 0.90	EEL=A3	
150/40%	HS	1.80	PRKUNaH 150/40%.142	538692	230, 50	0.77	yes	151	120	154	79	60	2.3	> 0.90	EEL=A3	
70/40%	HS	0.98	PRKUNaH 70/40%.525	538700	220, 60	0.38	no	117	86	151	76	60	1.5	> 0.90	EEL=A3	
100/40%	HS	1.20	PRKUNaH 100/40%.522	538701	220, 60	0.56	no	123	92	151	76	60	1.7	> 0.90	EEL=A3	
150/40%	HS	1.80	PRKUNaH 150/40%.142	538702	220, 60	0.77	no	151	120	154	79	60	2.3	> 0.90	EEL=A3	
Power reduction with control phase – Power switch PU 12 K																
70/40%	HS	0.98	PRKUNaH 70/40%.525	539329	220, 50	0.38	no	117	86	151	76	56	1.5	> 0.90	EEL=A3	
100/40%	HS	1.20	PRKUNaH 100/40%.522	539331	220, 50	0.56	no	123	92	151	76	56	1.7	> 0.90	EEL=A3	
150/40%	HS	1.80	PRKUNaH 150/40%.142	539333	220, 50	0.77	no	151	120	154	79	56	2.3	> 0.90	EEL=A3	
70/40%	HS	0.98	PRKUNaH 70/40%.525	538695	230, 50	0.38	yes	117	86	151	76	56	1.5	> 0.90	EEL=A3	
100/40%	HS	1.20	PRKUNaH 100/40%.522	538696	230, 50	0.56	yes	123	92	151	76	56	1.7	> 0.90	EEL=A3	
150/40%	HS	1.80	PRKUNaH 150/40%.142	538697	230, 50	0.77	yes	151	120	154	79	56	2.3	> 0.90	EEL=A3	
70/40%	HS	0.98	PRKUNaH 70/40%.525	538705	220, 60	0.38	no	117	86	151	76	56	1.5	> 0.90	EEL=A3	
100/40%	HS	1.20	PRKUNaH 100/40%.522	538706	220, 60	0.56	no	123	92	151	76	56	1.7	> 0.90	EEL=A3	
150/40%	HS	1.80	PRKUNaH 150/40%.142	538707	220, 60	0.77	no	151	120	154	79	56	2.3	> 0.90	EEL=A3	

* Step 2: EEL = A3, minimum EU energy efficiency requirements as of 2012 | Step 3: A2, minimum EU energy efficiency requirements as of 2017

Compact Power Reduction Kits for HS Lamps 250 and 400 W

Ballast shape: 71x75 mm

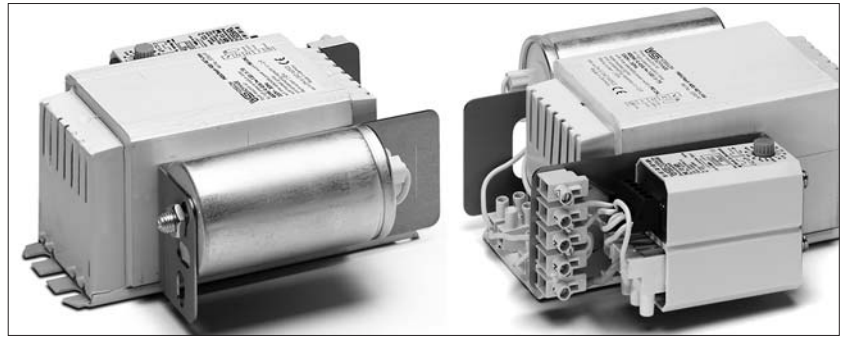

For high pressure sodium lamps (HS)
Compact power reduction kit with ballast with or without thermal cut-out with automatic reset, superimposed ignitor, power switch and compensation capacitor
With luminaire terminal block:
screw terminal 0.75-2.5 mm²
With earth terminal
Permissible load capacity: 20-100 pF
Lead length to the lamp: max. 1.5 m
tw 130
Further outputs and voltages on request
With digital timer ignitor on request

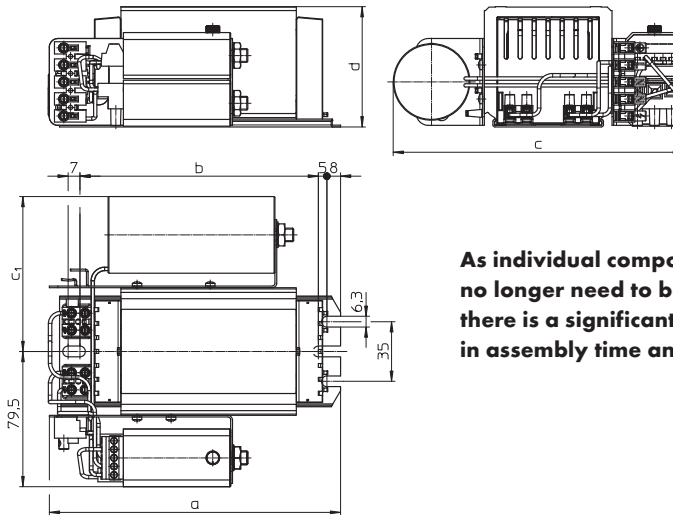

As individual components no longer need to be wired, there is a significant reduction in assembly time and costs.

Lamp			Power reduction kit											Weight kg	Power factor λ	Energy efficiency*
Output W	Type	Current A	Type	Ref. No.	Voltage AC V, Hz	Mains current A	Temperature protection	a mm	b mm	c mm	c1 mm	d mm				
Power reduction without control phase – Intelligent power switch PR 12 K LC (Light Control)																
250/40%	HS	3.00	PRKUNaH 250/40%.936	543386	220, 50	1.26	no	141	110	171	91	71	3.3	> 0.90	EEl=A3	
400/40%	HS	4.45	PRKUNaH 400/40%.906	543389	220, 50	1.95	no	171	140	171	91	71	5.3	> 0.90	A2	
250/40%	HS	3.00	PRKUNaH 250/40%.936	543745	230, 50	1.26	yes	141	110	171	91	71	3.3	> 0.90	EEl=A3	
400/40%	HS	4.45	PRKUNaH 400/40%.906	543746	230, 50	1.95	yes	171	140	171	91	71	5.3	> 0.90	A2	
Power reduction without control phase – Power switch PR 12 KD with selectable switching time																
250/40%	HS	3.00	PRKUNaH 250/40%.758	546585	220, 50	1.26	no	171	140	171	91	71	5.3	> 0.90	EEl=A3	
250/40%	HS	3.00	PRKUNaH 250/40%.936	539334	220, 50	1.26	no	141	110	171	91	71	3.3	> 0.90	EEl=A3	
400/40%	HS	4.45	PRKUNaH 400/40%.906	539335	220, 50	1.95	no	171	140	171	91	71	5.3	> 0.90	A2	
250/40%	HS	3.00	PRKUNaH 250/40%.936	538693	230, 50	1.26	yes	141	110	171	91	71	3.3	> 0.90	EEl=A3	
400/40%	HS	4.45	PRKUNaH 400/40%.906	538694	230, 50	1.95	yes	171	140	171	91	71	5.3	> 0.90	A2	
250/40%	HS	3.00	PRKUNaH 250/40%.983	538703	220, 60	1.26	no	141	110	165	86	71	3.3	> 0.90	EEl=A3	
400/40%	HS	4.45	PRKUNaH 400/40%.937	538704	220, 60	1.95	no	171	140	171	91	71	5.3	> 0.90	A2	
Power reduction with control phase – Power switch PU 12 K																
250/40%	HS	3.00	PRKUNaH 250/40%.936	539336	220, 50	1.26	no	141	110	171	91	71	3.3	> 0.90	EEl=A3	
400/40%	HS	4.45	PRKUNaH 400/40%.906	539337	220, 50	1.95	no	171	140	171	91	71	5.3	> 0.90	A2	
250/40%	HS	3.00	PRKUNaH 250/40%.936	538698	230, 50	1.26	yes	141	110	171	91	71	3.3	> 0.90	EEl=A3	
400/40%	HS	4.45	PRKUNaH 400/40%.906	538699	230, 50	1.95	yes	171	140	171	91	71	5.3	> 0.90	A2	
250/40%	HS	3.00	PRKUNaH 250/40%.983	538708	220, 60	1.26	no	141	110	165	86	71	3.3	> 0.90	EEl=A3	
400/40%	HS	4.45	PRKUNaH 400/40%.937	538709	220, 60	1.95	no	171	140	171	91	71	5.3	> 0.90	A2	

* Step 2: EEl = A3, minimum EU energy efficiency requirements as of 2012 | Step 3: A2, minimum EU energy efficiency requirements as of 2017

Ballasts for Power Reduction of HS Lamps 70 to 250 W

Shape: 53 x 66 mm

For high pressure sodium lamps (HS)
 Vacuum-impregnated with polyester resin
 Screw terminals: 0.5-2.5 mm²
 Protection class I
 tw 130

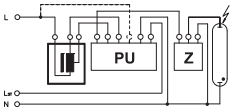
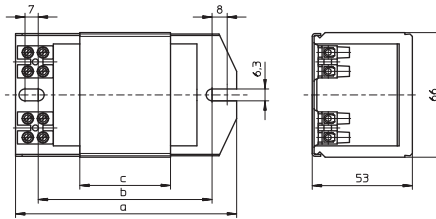

- 1
- 2
- 3
- 4
- 5
- 6
- 7
- 8
- 9
- 10

Lamp			Ballast										Capacitor	
Output W	Type	Current A	Type	Ref. No.	Voltage AC V, Hz	a mm	b mm	c mm	Weight kg	Δt K	Power factor λ	Energy efficiency*	Cp μF	I _N A
70 (42)	HS	0.98	UNaH 70/40%.501	534128	220, 50	108	86	42	1.23	65	0.39	EEl=A3	12	0.40
70 (42)	HS	0.98	UNaH 70/40%.525	535348	230, 50	108	86	42	1.23	70	0.38	EEl=A3	12	0.38
70 (42)	HS	0.98	UNaH 70/40%.691	161460	220, 60	108	86	48	1.39	60	0.42	EEl=A3	10	0.40
100 (60)	HS	1.20	UNaH 100/40%.452	533947	220, 50	117	92	55	1.52	65	0.43	EEl=A3	12	0.55
100 (60)	HS	1.20	UNaH 100/40%.522	535347	230, 50	117	92	55	1.52	70	0.42	EEl=A3	12	0.55
100 (60)	HS	1.20	NaHJ 100/70.709	161471	220, 60	145	120	48	1.39	60/50	0.44	EEl=A3	10	0.57
150 (90)	HS	1.80	UNaH 150/40%.453	533948	220, 50	145	120	75	2.03	75	0.42	EEl=A3	20	0.80
150 (90)	HS	1.80	UNaH 150/40%.142	535333	230, 50	145	120	75	2.03	75	0.40	EEl=A3	20	0.77
150 (90)	HS	1.80	UNaH 150/40%.717	161475	220, 60	145	120	75	2.03	70	0.44	EEl=A3	20	0.77
250 (150)	HS	3.00	UNaH 250/40%.454	533949	220, 50	180	155	110	2.88	80	0.42	EEl=A3	32	1.32
250 (150)	HS	3.00	UNaH 250/40%.983	169892	220, 60	145	120	75	2.03	75	0.40	EEl=A3	32	1.32

* Step 2: EEl = A3, minimum EU energy efficiency requirements as of 2012 | Step 3: A2, minimum EU energy efficiency requirements as of 2017

Ballasts with Thermal Cut-out for Power Reduction of HS Lamps 50 to 150 W

Shape: 53x66 mm

For high pressure sodium lamps (HS)
 Vacuum-impregnated with polyester resin
 Thermal cut-out with automatic reset
 Protection class I
 tw 130

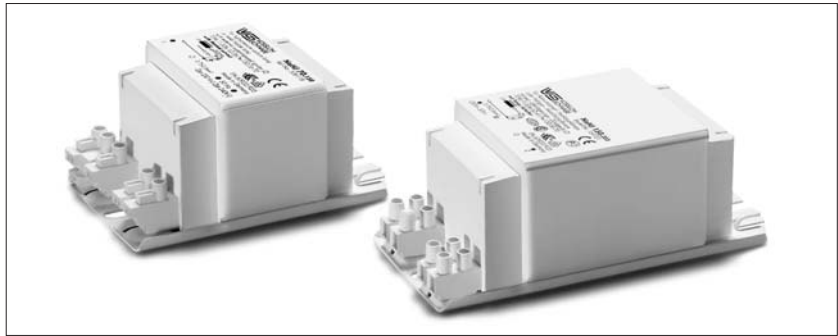

A Push-in terminals: 0.5–1.5 mm²

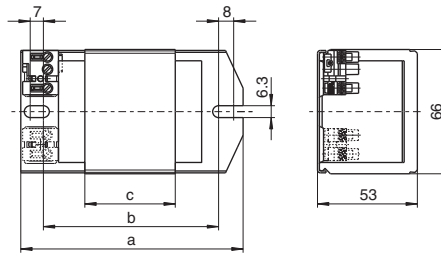

B Screw terminals: 0.5–2.5 mm²

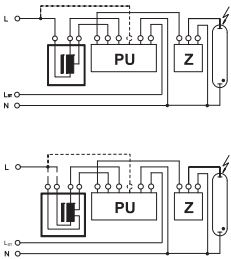
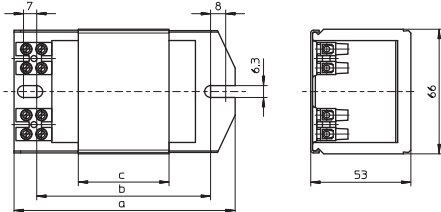

Lamp			Ballast											Capacitor	
Output W	Type	Current A	Type	Ref. No.	Voltage AC V, Hz	a mm	b mm	c mm	Drawing	Weight kg	Δt K	Power factor λ	Energy efficiency*	C _p μF	I _N A
With push-in terminals: 0.5–1.5 mm²															
70 (42)	HS	0.98	UNaH 70/40%.525	544728	230, 50	108	86	42	A	1.23	70	0.38	EEI=A3	12	0.38
100 (60)	HS	1.20	UNaH 100/40%.522	544730	230, 50	117	92	55	A	1.55	70	0.42	EEI=A3	12	0.55
150 (90)	HS	1.80	UNaH 150/40%.142	544729	230, 50	145	120	75	A	2.10	75	0.40	EEI=A3	20	0.77
150 (101)	HS	1.80	UNaH 150/100.722	539050	230/240, 50	160	135	95	A	2.50	65/50	0.41	EEI=A3	20	0.77
150 (101)	HS	1.80	UNaH 150/100.722	507627	230/240, 50	180	155	95	A	2.50	65/50	0.41	EEI=A3	20	0.77
With screw terminals: 0.5–2.5 mm²															
50 (33)	HS	0.76	NaH 50/35.797	539515	230, 50	108	86	36	B	1.07	70/45	0.37	EEI=A3	6	0.22
70 (44)	HS	0.98	NaHJ 70/50.695	503136	230, 50	108	86	48	B	1.34	70/50	0.37	EEI=A3	12	0.38
100 (64)	HS	1.20	NaHJ 100/70.703	504131	230, 50	117	92	48	B	1.39	70/60	0.43	EEI=A3	12	0.55
150 (101)	HS	1.80	NaHJ 150/100.973	504135	230, 50	145	120	75	B	2.10	75/55	0.41	EEI=A3/A2	20	0.77

* Step 2: EEI = A3, minimum EU energy efficiency requirements as of 2012 | Step 3: A2, minimum EU energy efficiency requirements as of 2017

Ballasts with Thermal Cut-out for Power Reduction of HS Lamps 70 to 150 W, Protection Class II

Encapsulated ballast in compact plastic casing
Shape: 61x72 mm

For high pressure sodium lamps (HS)
With cable holder
Thermal cut-out with automatic reset
Screw terminals: 0,5-2,5 mm²

Protection class II
tw 130

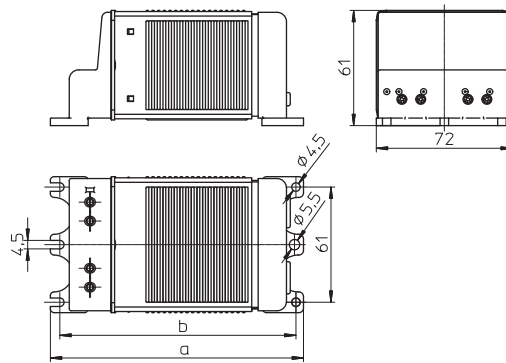
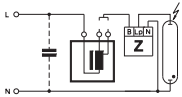

Lamp			Ballast									Capacitor	
Output W	Type	Current A	Type	Ref. No.	Voltage AC V, Hz	a mm	b mm	Weight kg	Δt K	Power factor λ	Energy efficiency*	C _p μF	I _N A
70 (44)	HS	0.98	NaHJZ 70/50.520	533395	230, 50	134	125	1.52	65/45	0.36	EEI=A3	12	0.38
100 (64)	HS	1.20	NaHJZ 100/70.519	533396	230, 50	161	152	2.10	60/45	0.42	EEI=A3	12	0.55
150 (101)	HS	1.80	NaHJZ 150/100.466	533398	230, 50	161	152	2.30	70/45	0.39	EEI=A3	20	0.77

* Step 2: EEI = A3, minimum EU energy efficiency requirements as of 2012 | Step 3: A2, minimum EU energy efficiency requirements as of 2017

Ballasts for Power Reduction of HS Lamps 250 to 600 W

Shape: 71x75 mm
Shape: 92x102 mm

For high pressure sodium lamps (HS)
Vacuum-impregnated with polyester resin
Screw terminals: 0.75-2.5 mm²
Protection class I
tw 130

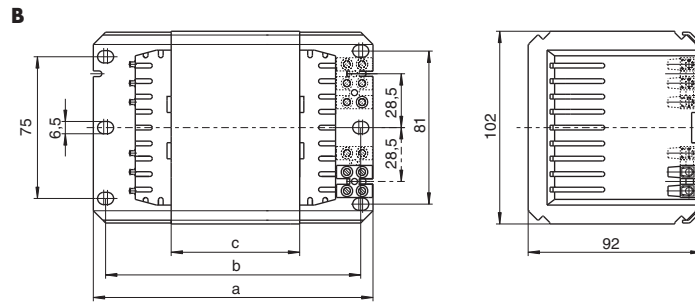
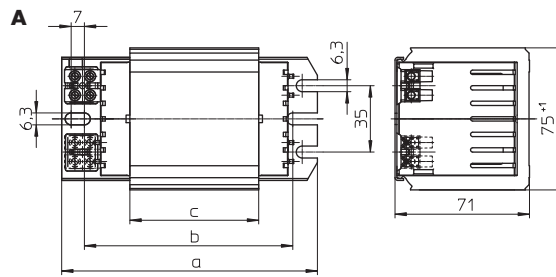
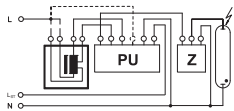
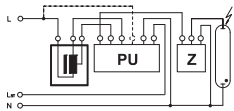
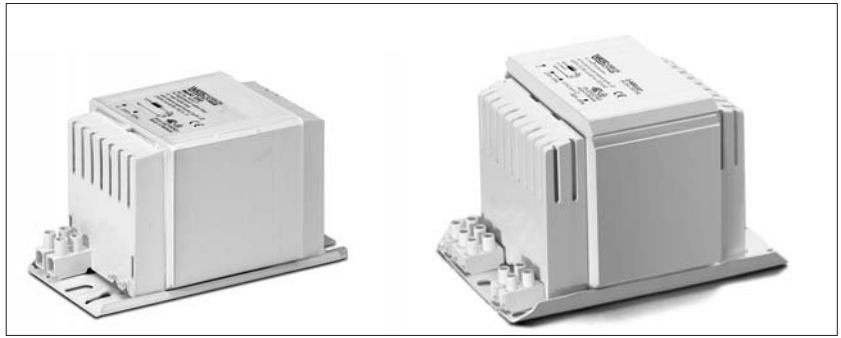

Lamp			Ballast											Capacitor	
Output	Type	Current	Type	Ref. No.	Voltage AC	Drawing	a	b	c	Weight	Δt	Power factor	Energy efficiency*	C _P	I _N
W		A			V, Hz		mm	mm	mm	kg	K	λ		μF	A
250 (150)	HS	3.00	UNaH 250/40%.746	539283	220, 50	A	135	115	68	2.85	75	0.42	EEI=A3	32	1.35
250 (150)	HS	3.00	UNaH 250/40%.936	543747	230, 50	A	135	115	68	2.85	75	0.40	EEI=A3	32	1.30
250 (150)	HS	3.00	UNaH 250/40%.747	539517	220, 60	A	135	115	68	2.85	75	0.42	EEI=A3	25	1.40
400 (240)	HS	4.45	UNaH 400/40%.892	538592	220, 50	A	165	145	103	4.13	75	0.44	A2	45	2.10
400 (240)	HS	4.45	UNaH 400/40%.906	543748	230, 50	A	165	145	103	4.13	75	0.42	A2	45	2.00
400 (240)	HS	4.45	UNaH 400/40%.937	538715	220, 60	A	165	145	103	4.13	75	0.44	A2	40	2.05
600 (360)	HS	6.20	UNaH 600/40%.060	539384	230/240, 50	B	173	160	108	6.80	75	0.44	A2	65	2.80

* Step 2: EEI = A3, minimum EU energy efficiency requirements as of 2012 | Step 3: A2, minimum EU energy efficiency requirements as of 2017

With Thermal Cut-out

Thermal cut-out with automatic reset

Lamp			Ballast											Capacitor	
Output	Type	Current	Type	Ref. No.	Voltage AC	Drawing	a	b	c	Weight	Δt	Power factor	Energy efficiency*	C _P	I _N
W		A			V, Hz		mm	mm	mm	kg	K	λ		μF	A
250 (150)	HS	3.00	UNaH 250/40%.936	538711	230, 50	A	135	115	68	2.85	75	0.40	EEI=A3	32	1.30
400 (240)	HS	4.45	UNaH 400/40%.906	538710	230, 50	A	165	145	103	4.13	75	0.42	A2	45	2.00

* Step 2: EEI = A3, minimum EU energy efficiency requirements as of 2012 | Step 3: A2, minimum EU energy efficiency requirements as of 2017

1

2

3

4

5

6

7

8

9

10

SUPERIMPOSED, PULSE AND INSTANT RESTRIKE

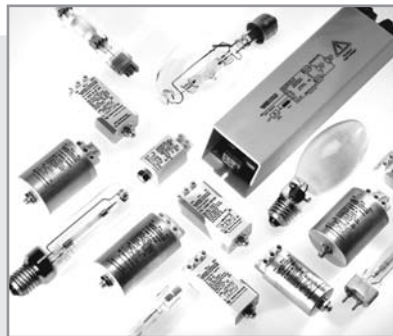

ELECTRONIC IGNITORS

Superimposed ignitors

Superimposed ignitors work independently of ballasts and generate defined ignition pulses during every half-wave within the stipulated voltage ranges. As the mains frequency only plays a subordinate role, these systems work equally well at 50 Hz and 60 Hz.

Superimposed ignitors should be mounted near the lampholder. The clearance needed between the ignitor and the lamp is determined by the respective maximum load capacitance, which is specified for each ignitor in the technical details. The capacitive load of the cable is dependent on its physical properties and wiring layout; this value usually ranges between 70-100 pF per metre.

Pulse ignitors

As pulse ignitors use the winding of an inductive ballast to generate the requisite pulse voltage, such ballasts must be designed to withstand these high ignition voltages.

Instant restrike ignitors

Instant restrike ignitors are a special type of ignitor for high-pressure discharge lamps. In comparison to superimposed and pulse ignitors, instant restrike ignitors have a very specified field of application. However, safety-relevant lighting systems, e.g. in power plants, stadiums, but also in television studios, make instant re-ignition of hot high-pressure discharge lamps necessary.

On the following pages, Vossloh-Schwabe presents an extensive range of ignitors for all areas of application.

Electronic superimposed ignitors	44–52
Pulse ignitors	53–54
Instant restrike ignitors	55–56
Electronic power switches	57
Electronic superimposed ignitors with power switch	58
Switch units for electronic operating devices with 1–10 V interface	59
Start-up switches	60–61
Electronic discharge units	62
Technical details for discharge lamps	83–123
General technical details	366–374
Glossary	375–377

Electronic Superimposed Ignitors for HS Lamps up to 70 W

Standard version or with automatic switch-off
 For high pressure sodium lamps (HS) and ceramic discharge lamps C-HI-TT/ET with base E27
 Phasing of the ignition voltage:
 60-90 °el and 240-270 °el
 Max. permitted casing temperature: 105 °C
 Fastening: male nipple with pre-assembled washer and nut
 For luminaires of protection class I and II

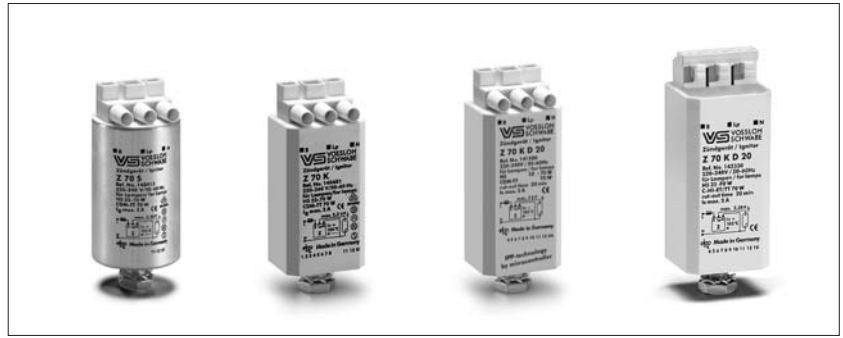

Al casing

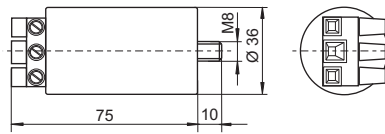

PC casing – K

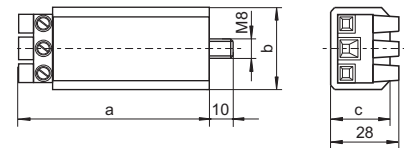

PC casing – K D20

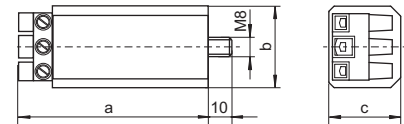

PC casing – with push-in terminals

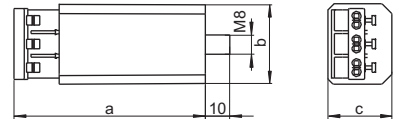

Type	Ref. No.	Voltage AC 50-60 Hz V	Max. lamp A	Internal loss W	Inherent heating K	Ignition voltage kV	Load capacity pF	Switch-off time sec./Hz	Casing d (Ø) mm	a mm	b mm	c mm	Weight g
Aluminium casing (Al) with screw terminals: 0.75-4 mm²													
Z 70 S	140413	220-240	2	< 0.6	< 5	1.8-2.3	20-200	-	35	76	-	-	135
Plastic casing (PC) with screw terminals: 0.75-4 mm²													
Z 70 K	140481	220-240	2	< 0.6	< 5	1.8-2.3	20-200	-	-	78	34	27	125
Z 70 K D20	141580*	220-240	2	< 0.6	< 5	1.8-2.3	20-100	1216/50-60	-	80	34	30	145
Plastic casing (PC) with push-in terminals: 0.5-2.5 mm²													
Z 70 K	142320	220-240	2	< 0.6	< 5	1.8-2.3	20-200	-	-	81	34	27	125
Z 70 K D20	142330*	220-240	2	< 0.6	< 5	1.8-2.3	20-100	1216/50-60	-	83	34	30	145

* With IPP technology

Electronic Superimposed Ignitors for HS Lamps 70 (DE) to 250 W and HI Lamps 35 to 250 W

Standard version or with automatic switch-off
 For high pressure sodium lamps (HS), metal halide lamps (HI) and ceramic discharge lamps (C-HI)
 Phasing of the ignition voltage: 60-90 °el and 240-270 °el
 Max. permitted casing temperature: 105 °C
 Fastening: male nipple with pre-assembled washer and nut
 For luminaires of protection class I and II



Al casing

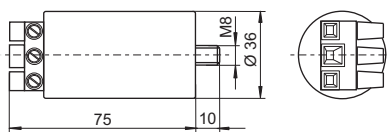

PC casing – K

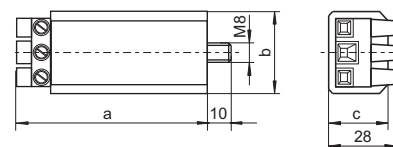

PC casing – K D20

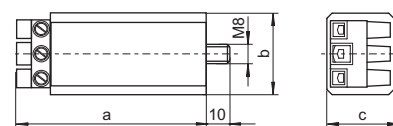

PC casing – with push-in terminals

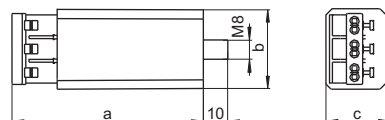

Type	Ref. No.	Voltage AC 50-60 Hz V	Max. lamp current A	Internal loss W	Inherent heating K	Ignition voltage kV	Load capacity pF	Switch-off time sec./Hz	Casing d (∅)			Weight g	
									a	b	c		
Aluminium casing (Al) with screw terminals: 0.75-4 mm²													
Z 250 S	140425	220-240	3.5	< 1.8	< 20	4-5	20-100	-	35	76	-	-	140
Plastic casing (PC) with screw terminals: 0.75-4 mm²													
Z 250 K	140489	220-240	3.5	< 1.8	< 20	4-5	20-100	-	-	78	34	27	130
Z 250 K D20	141581*	220-240	3.5	< 1.8	< 20	4-5	20-100	1216/50-60	-	80	34	30	145
Plastic casing (PC) with push-in terminals: 0.5-2.5 mm²													
Z 250 K	142340	220-240	3.5	< 1.8	< 20	4-5	20-100	-	-	81	34	27	130
Z 250 K D20*	142350*	220-240	3.5	< 1.8	< 20	4-5	20-100	1216/50-60	-	83	34	30	145

* With IPP technology

Electronic Superimposed Ignitors for HS Lamps 70 (DE) to 400 W and HI Lamps 35 to 400 W

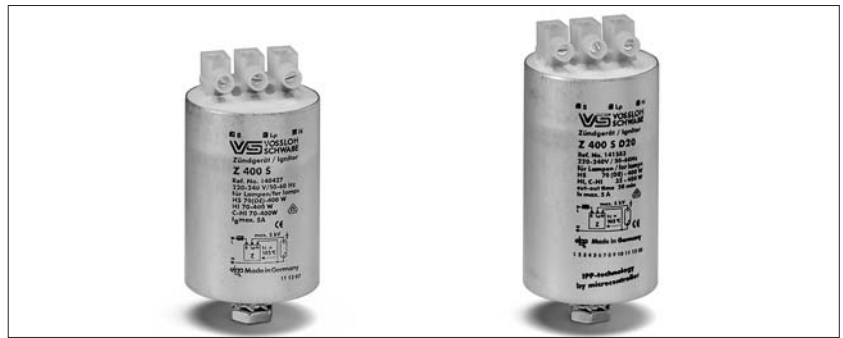

Standard version or with automatic switch-off
 For high pressure sodium lamps (HS),
 metal halide lamps (HI) and
 ceramic discharge lamps (C-HI)
 Phasing of the ignition voltage:
 60-90 °el and 240-270 °el
 Max. permitted casing temperature: 105 °C
 Screw terminals: 0.75-4 mm²
 Fastening: male nipple with pre-assembled
 washer and nut
 For luminaires of protection class I and II

Al casing

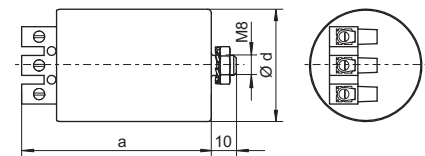

Type	Ref. No.	Voltage AC 50-60 Hz V	Max. lamp current A	Internal loss W	Inherent heating K	Ignition voltage kV	Load capacity pF	Switch-off time sec./Hz	Casing			Weight g	
									d (Ø) mm	a mm	b mm		c mm
Aluminium casing (Al)													
Z 400 S	140427	220-240	5	< 3	< 25	4-5	20-100	-	45	76	-	-	250
Z 400 S D20	141583*	220-240	5	< 3	< 25	4-5	20-100	1216/50-60	45	90	-	-	280

* With IPP technology

Electronic Superimposed Ignitors for HS Lamps 70 (DE) to 400 W and HI Lamps 35 to 400 W

Standard version or with automatic switch-off Compact shape

For high pressure sodium lamps (HS), metal halide lamps (HI) and ceramic discharge lamps (C-HI)

Ignition voltage: 4-5 kV

Phasing of the ignition voltage: 60-90 °el and 240-270 °el

Max. permitted casing temperature: 105 °C

Fastening: male nipple with pre-assembled washer and nut

For luminaires of protection class I and II

For luminaires of protection class I

(140594, 147707)



Al casing

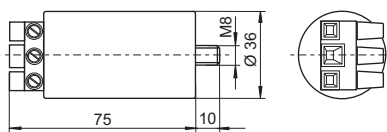

PC casing – K

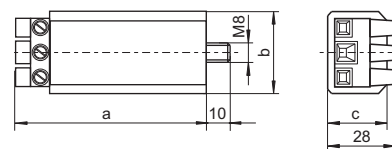

PC casing – K D20

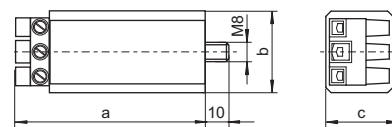

PC casing – with push-in terminals

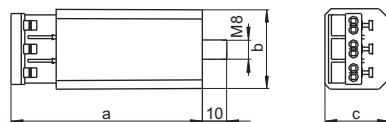

Type	Ref. No.	Voltage AC 50-60 Hz V	Max. lamp current A	Internal loss W	Inherent heating K	Ignition voltage kV	Load capacity pF	Switch-off time sec./Hz	Casing d (∅)	a	b	c	Weight g
Aluminium casing (Al) with screw terminals: 0.75-4 mm²													
Z 400 M	140594	220-240	5	< 3	< 35	4-5	20-50	-	35	76	-	-	140
Z 400 M VS-Power	147707**	220-240	5	< 3	< 35	4-5	20-50	-	35	76	-	-	140
Z 400 M S	140693	220-240	5	< 3	< 35	4-5	20-50	-	35	76	-	-	140
Plastic casing (PC) with screw terminals: 0.75-4 mm²													
Z 400 M K	140597	220-240	5	< 3	< 35	4-5	20-50	-	-	78	34	27	130
Z 400 M K VS-Power	142897**	220-240	5	< 3	< 35	4-5	20-50	-	-	78	34	27	130
Z 400 M K D20	141582*	220-240	5	< 3	< 35	4-5	20-50	1216/50-60	-	80	34	30	145
Plastic casing (PC) with push-in terminals: 0.5-2.5 mm²													
Z 400 M K	142360	220-240	5	< 3	< 35	4-5	20-50	-	-	81	34	27	130
Z 400 M K VS-Power	142361**	220-240	5	< 3	< 35	4-5	20-50	-	-	81	34	27	130
Z 400 M K D20	142370*	220-240	5	< 3	< 35	4-5	20-50	1216/50-60	-	83	34	30	145

Recommended for outdoor lighting

* With IPP technology

** Not suitable for C-HI lamps

Electronic Superimposed Ignitors for HS Lamps 600 and 750 W



Standard version

For high pressure sodium lamps (HS)

Phasing of the ignition voltage:

60-90 °el and 240-270 °el

Max. permitted casing temperature: 105 °C

Screw terminals: 0.75-4 mm²

Fastening: male nipple with pre-assembled washer and nut

For luminaires of protection class I and II

Al casing

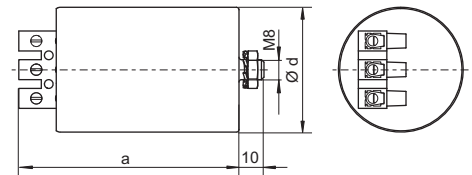

Type	Ref. No.	Voltage AC 50 - 60 Hz V	Max. lamp current A	Internal loss W	Inherent heating K	Ignition voltage kV	Load capacity pF	Switch-off time sec./Hz	Casing			Weight g	
									d (Ø) mm	a mm	b mm		c mm
Aluminium casing (Al)													
Z 750 S	146990	220 - 240	8	< 3	< 20	4 - 5	20 - 100	-	50	90	-	-	360

Electronic Superimposed Ignitors for HS and HI Lamps 250 to 1000 W

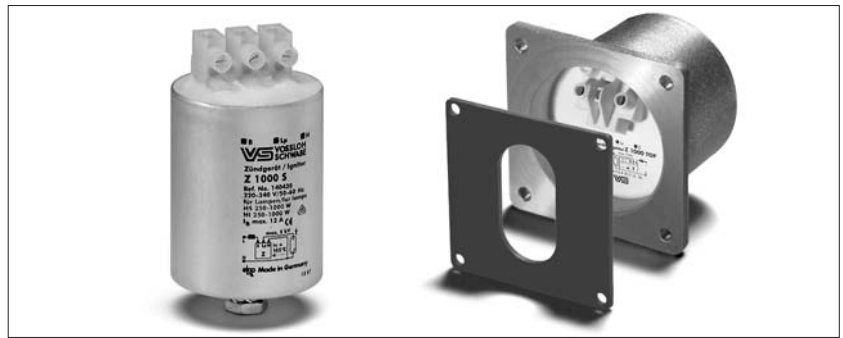

Standard version or with automatic switch-off
 For high pressure sodium lamps (HS)
 and metal halide lamps (HI)
 Phasing of the ignition voltage:
 60-90 °el and 240-270 °el
 Max. permitted casing temperature: 105 °C
 Screw terminals: 0.75-2.5 mm²
 (Z 1000 S: 0.75-4 mm²)
 Fastening: male nipple with pre-assembled
 washer and nut
 For luminaires of protection class I and II

Al casing

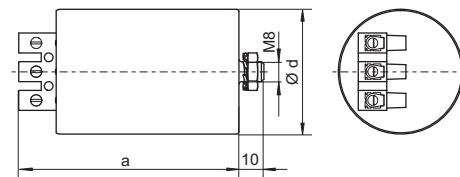

Z 1000 TOP

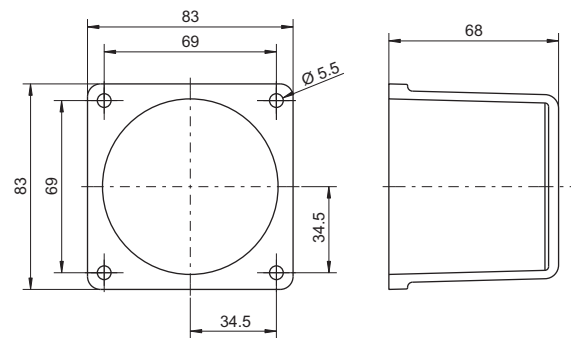

Type	Ref. No.	Voltage AC 50-60 Hz V	Max. lamp current A	Internal loss W	Inherent heating K	Ignition voltage kV	Load capacity µF	Switch-off time sec./Hz	Casing			Weight g	
									d (Ø) mm	a mm	b mm		c mm
Aluminium casing (Al)													
Z 1000 S	140430	220-240	12	< 6	< 35	4-5	20-100	—	50	80	—	—	340
Z 1000 TOP	140607**	220-240	12	< 6	< 35	4-5	20-100	—	—	83	83	68	620
Z 1000 S D20	141584*	220-240	12	< 6	< 35	4-5	20-100	1216/50-60	50	80	—	—	340

* With IPP technology

** For flange-mounting with gasket for degree of protection IP55

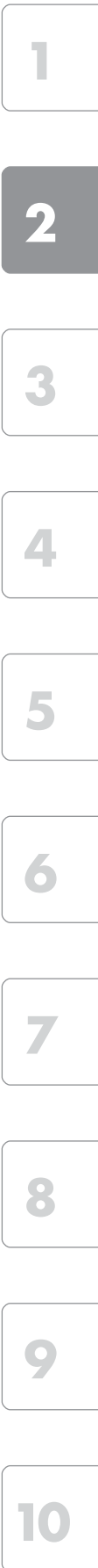

Electronic Superimposed Ignitors for HS and HI Lamps up to 1000 W



Standard version

For high pressure sodium lamps (HS) and metal halide lamps (HI)

For long lead lengths

Max. permitted casing temperature: 105 °C

Screw terminals: 0.75–2.5 mm²

Fastening: male nipple with pre-assembled washer and nut

Al casing

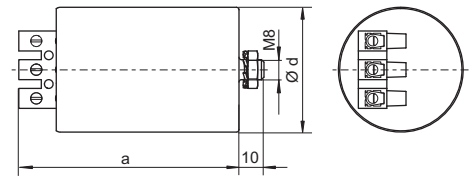

For HS and HI lamps 150 to 1000 W

Phasing of the ignition voltage: 60–90 °el

For luminaires of protection class I

Type	Ref. No.	Voltage AC 50–60 Hz V	Max. lamp current A	Internal loss W	Inherent heating K	Ignition voltage kV	Load capacity pF	Switch-off time sec./Hz	Casing				Weight g
									d (∅) mm	a mm	b mm	c mm	
Aluminium casing (Al)													
Z 1000 L	140471 *	220–240	12	< 6	< 35	4–5	20–2000	–	50	97	–	–	340

* Not suitable for HI lamps types NDL, WDL or for HS lamps types S, de-Luxe, Comfort or similar

For HS lamps 600 to 1000 W/400 V and HI lamps 1000 W/400 V

Phasing of the ignition voltage:

60–90 °el and 240–270 °el

For luminaires of protection class I and II

Type	Ref. No.	Voltage AC 50–60 Hz V	Max. lamp current A	Internal loss W	Inherent heating K	Ignition voltage kV	Load capacity pF	Switch-off time sec./Hz	Casing				Weight g
									d (∅) mm	a mm	b mm	c mm	
Aluminium casing (Al)													
Z 1000 S/400 V	140496	380–415	6	< 3.3	< 28	4–5	20–2000	–	45	84	–	–	295

Electronic Superimposed Ignitors for Projection Lamps up to 1200 W

Standard version

For high-pressure discharge lamps

Phasing of the ignition voltage:

60–90 °el and 240–270 °el

Max. permitted casing temperature: 105 °C

Screw terminals: 0.75–2.5 mm²

Fastening: male nipple with pre-assembled washer and nut

For luminaires of protection class I



Al casing

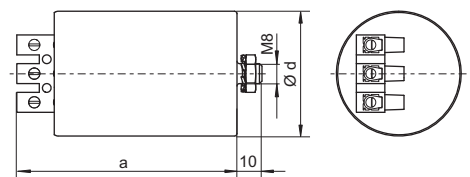

Type	Ref. No.	Voltage AC 50–60 Hz V	Max. lamp current A	Internal loss W	Inherent heating K	Ignition voltage kV	Load capacity pF	Switch-off time sec./Hz	Casing				Weight g
									d (Ø) mm	a mm	b mm	c mm	
Aluminium casing (Al)													
Z 1200/2.5	140608*	220–240	15	< 7.5	< 40	2–2.5	20–200	–	50	80	–	–	330
Z 1200/9	140609**	220–240	15	< 10	< 40	7–8	20–50	–	50	135	–	–	650

* For lamps, e.g. HSR, MSR, SN

** For lamps, e.g. HMI, HTI, CDI, RSI, CSR

Electronic Superimposed Ignitors for HI Lamps up to 3500 W

Standard version

For metal halide lamps (HI)

Phasing of the ignition voltage:

60-90 °el and 240-270 °el

Max. permitted casing temperature: 105 °C

Screw terminals: 0.75-2.5 mm²

Fastening: male nipple with pre-assembled washer and nut

For luminaires of protection class I and II

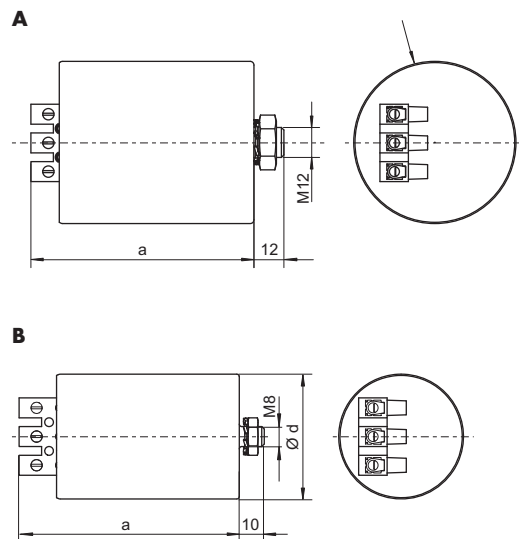

Type	Ref. No.	Voltage AC 50-60 Hz V	Max. lamp current A	Internal loss W	Inherent heating K	Ignition voltage kV	Load capacity pF	Switch-off time sec./Hz	Drawing	Casing			Weight g	
										d (Ø) mm	a mm	b mm		c mm
Aluminium casing (Al)														
Z 2000 S	140432	220-240	20	< 6	< 30	4-5	20-100	-	A	65	96	-	-	640
Z 2000 S/400 V	140497	380-415	12.7	< 5	< 32	4-5	20-2000	-	B	50	88	-	-	340
Z 3500 S/400 V	140499	380-415	20	< 7	< 35	4-5	20-100	-	A	65	96	-	-	650

Pulse Ignitors for HS and HI Lamps up to 1000 W

With automatic switch-off

For high pressure sodium lamps (HS), metal halide lamps (HI) and ceramic discharge lamps (C-HI)

Max. permitted casing temperature: 95 °C

Screw terminals: 0.75-2.5 mm²

Fastening: male nipple with pre-assembled washer and nut

For luminaires of protection class I

This pulse ignitor is only for use with ballasts that have a dedicated tapping, as this determines the size of the ignition voltage.



Al casing

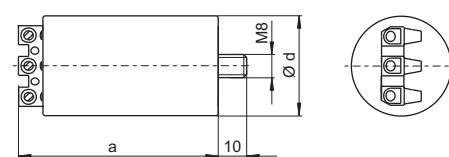

PC casing

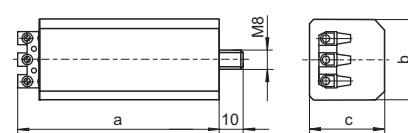

For HS lamps 50 to 1000 W, HI lamps 35 to 1000 W and C-HI lamps 35 to 400 W

Type	Ref. No.	Voltage AC 50-60 Hz V	Number of ignition pulses per mains period	Ignition voltage kV	Load capacity pF	Programmed switch-off time sec./Hz	Casing			Weight g
							a mm	b mm	c mm	
Plastic casing (PC)										
PZ 1000 K D20	142784*	220-240 ±10%	≥ 2	1.8-2.3/4-5	20-1000	1216/50-60	74	34	27	100

With IPP technology

* Suitable ballasts (type: NaHJ...PZT) are available on request

For HS lamps 600 to 1000 W/400 V and HI lamps 1000 W/400 V

Type	Ref. No.	Voltage AC 50-60 Hz V	Number of ignition pulses per mains period	Ignition voltage kV	Load capacity pF	Programmed switch-off time sec./Hz	Casing				Weight g
							d (Ø) mm	a mm	b mm	c mm	
Aluminium casing (Al)											
PZ 1000/400 V A5	142783*	380-420	≥ 1	4-5	20-800	300/50	40	80	-	-	155

* Suitable ballasts (type: NaHJ...PZT) are available on request

Pulse Ignitors for HS Lamps 50 to 1000 W

Standard version

For standard high pressure sodium lamps (HS)

Max. permitted casing temperature: 95 °C

Screw terminals: 0.5-1.5 mm²

Fastening: male nipple with pre-assembled washer and nut

For luminaires of protection class I

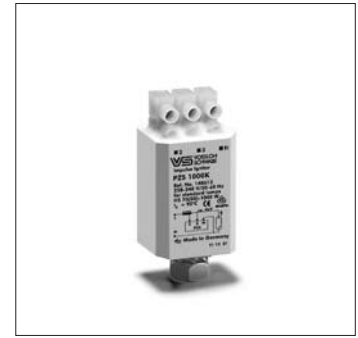
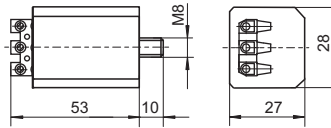

Type	Ref. No.	Voltage AC 50-60 Hz V	Number of ignition pulses per mains period	Ignition voltage kV	Load capacity pF	Programmed switch-off time sec.	Casing				Weight g
							d (∅) mm	a mm	b mm	c mm	

Plastic casing (PC)

PZS 1000 K	140613	220-240	approx. 1/sec.	approx. 4	20-4000	–	–	50	28	27	50
------------	---------------	---------	----------------	-----------	---------	---	---	----	----	----	----

Not suitable for HS lamps types Plus, Super, XL, HO

Suitable ballasts (type: NaH...P) are available on request

Pulse Ignitors for HI Lamps 250 to 2000 W, Ignition Voltage up to 1 kV

Standard version

For metal halide lamps (HI)

with ignition voltage of 0.9 kV

Max. permitted casing temperature: 95 °C

Screw terminals: 0.5-2.5 mm²

Fastening: male nipple with pre-assembled washer and nut

For luminaires of protection class I

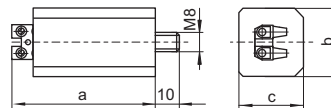

Type	Ref. No.	Voltage AC 50-60 Hz V	Number of ignition pulses per mains period	Ignition voltage kV	Load capacity pF	Programmed switch-off time sec.	Casing			Weight g
							a mm	b mm	c mm	

Plastic casing (PC)

PZI 1000/1 K	140617	220-240	≥ 1	0.7-0.9	max. 10000	–	57	28	27	50
--------------	---------------	---------	-----	---------	------------	---	----	----	----	----

Suitable ballasts see page 32, 33 and 34

Instant Restrike Ignitors for High-pressure Discharge Lamps up to 600 W



For high pressure sodium lamps (HS), metal halide lamps (HI), ceramic discharge lamps (C-HI) and projection lamps in accordance with the lamp table shown below
For installation as a symmetric ignition device (whereby the ignition voltage is split equally over both lamp electrodes)

For installation in luminaires of protection class I
Max. permitted ambient temperature t_a : 60 °C
Mains connection: screw terminal 3-poles, 0.75-2.5 mm²

Lamp connection: screw terminal 0.75-2.5 mm² for circuit 1 and 2

Fastening: 2 mounting slots for screws M4

Material: plastic casing made of ABS

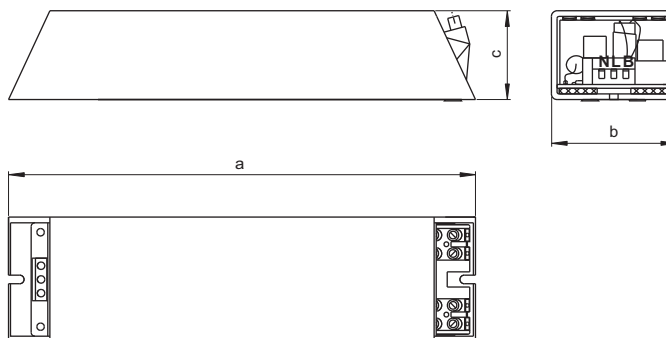

CAUTION

Defective lamps must be replaced immediately

Circuit 1

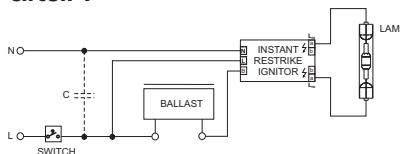

Circuit 2

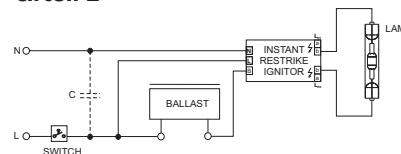

Type	Ref. No.	Voltage AC 50-60 Hz V	Max. lamp current A	Internal loss W	Inherent heating K	Ignition voltage* kV	Ignition time sec.	Load capacity pF	Casing			Weight g
									a mm	b mm	c mm	
HZ 600 K	147790	230 ±10%	8	< 4	< 10	20-30	approx. 6	5-30	247	66	47	1000

* Depending on the respective circuit, the ignition voltage is split equally over both lamp electrodes

Lamp table						
Circuit 1				Circuit 2		
Lamp type	Base	VS lampholder type	Catalogue page	Lamp type	Base	VS lampholder type
CDM-TD 70 W	RX7s	306	80	HBO 50 W	SFa8-2	-
HCI-TS 70 W	RX7s	306	80	MSR 125 HR	GZX9.5	-
HI 70 W (DE)	RX7s	306	80	HBO 200 W	SFc10.4	-
HS 70 W (DE)	RX7s	306	80	HBO 200 W	SFc10.4	-
RCI-TS 70 W	RX7s	306	80	MSR 200 HR	GZX9.5	-
HS 150 W (DE)	RX7s	306	80	HTI 250 W	FaX1.5	-
HMI 200 W	X515	-		HMI 400 W/SE	GZZ9.5	-
HMI 200 W/X	GZY9.5	-		HMP 400 W	FaX1.5	-
MSI 200 W	GZY9.5	-		HTI 400 W	FaX1.5	-
RSI 200 W	X515	-		RSI 400 W	GZX9.5	-
HS 250 W (DE)	Fc2	025	80-81	HBO 500 W	SFcY13-5	-
HS 400 W (DE)	Fc2	025	80-81	HMP 575 W	SFc10.4 / G22	-
MSR 400 HR	GZZ9.5	-		HMI 575 W	SFc10.4	-
MSI 575 W	SFc10	-		RSI 575 W	G22	-
MSR 575 HR	G22	-		HTI 600 W	FaX1.5	-

Instant Restrike Ignitors for High-pressure Discharge Lamps 1000 W/230 V and 2000 W/400 V



For high pressure sodium lamps (HS), metal halide lamps (HI), ceramic discharge lamps (C-HI) in accordance with the lamp table shown below
For installation as a symmetric ignition device (whereby the ignition voltage is split equally over both lamp electrodes)

Degree of protection: IP65

For installation in luminaires of protection class I

Max. permitted ambient temperature t_a : 60 °C

Mains connection: screw terminal 3-poles, max. 4 mm²

Earth connection: screw terminal max. 4 mm²

Lamp connection: screw terminal max. 4 mm²

Fastening: 4 holes Ø 6.3 mm in the base of casing

Material: casing made of fibreglass-reinforced polyester

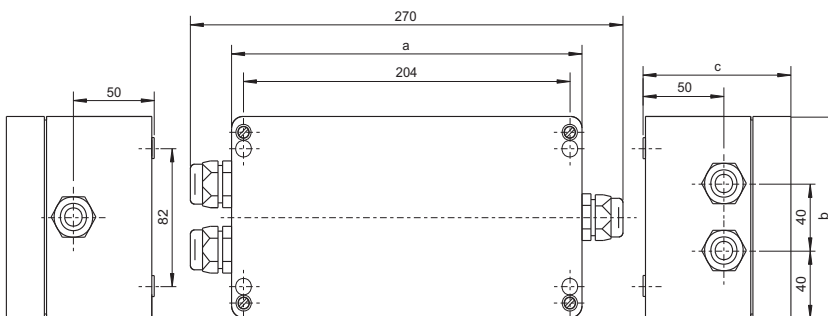

Circuit diagram HZ 1000 K/230V

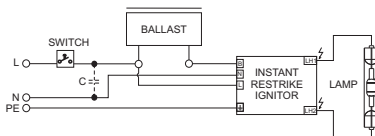

Circuit diagram HZ 2000 K/400 V

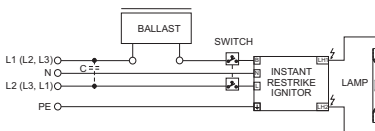

CAUTION

Defective lamps must be replaced immediately

Type	Ref. No.	Voltage AC 50-60 Hz V	Max. lamp current A	Internal loss W	Inherent heating K	Ignition voltage* kV	Ignition time sec.	Load capacity pF	Casing			Weight g
									a mm	b mm	c mm	
HZ 1000 K	147791	230 ±10%	12	< 5	< 10	36	approx. 6	5-50	218	120	92	3745
HZ 2000 K/400 V	147793	400 ±10%	12.7	< 5	< 10	36	approx. 6	5-30	218	120	92	3745

* The ignition voltage is split equally over both lamp electrodes

Lamp table HZ 1000 K

Lamp type	Lamp manufacturer	Base	VS lampholder type	Catalogue page	Lamp type	Base	VS lampholder type	Catalogue page
CDM-TD 150 W	Philips	RX7s	306	80	HI 400 W (DE)	Fc2	025	80-81
HCI-TS 150 W	Osram	RX7s	306	80	HS 400 W (DE)	Fc2	025	80-81
HI 150 W (DE)		RX7s	306	80	HI 1000 W (DE)	Fc2	025	80-81
HS 150 W (DE)		RX7s	306	80	HS 1000 W (DE)	Cable, K12s-7	211	82
HI 250 W (DE)		Fc2	025	80-81	-	-	-	-
HS 250 W (DE)		Fc2	025	80-81	-	-	-	-

Lamp table HZ 2000 K/400 V

Lamp type	Base	VS lampholder type	Catalogue page	Note
HI 2000 W (DE)	Cable, K12s-7	211	82	not suitable for HRI-TS 2000 W/N/L, HQI-TS 2000 W/N/L

Electronic Power Switches for HS Lamps up to 600 W and HM Lamps up to 700 W



For high pressure sodium lamps (HS) and mercury vapour lamps (HM)
 For power reduction by using ballasts with multiple voltage tapping and superimposed ignitors
 PR 12 K LC and PR 12 K D are also suitable for power switching of LED drivers and electronic ballasts.
 Casing: PC
 Max. permitted casing temperature t_c : 80 °C
 Screw terminals: 0.75–2.5 mm²
 Fastening: male nipple with pre-assembled washer and nut
 For luminaires of protection class I and II
 Circuit diagrams for power reduction see pages 99–100.

PU 12 K/PR 12 KD/PR 12 K LC

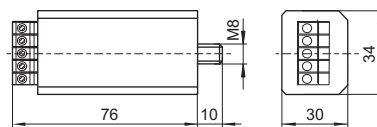

PU 120 K

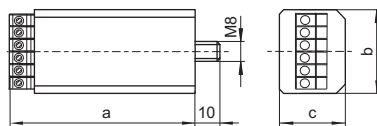

PU 121 K

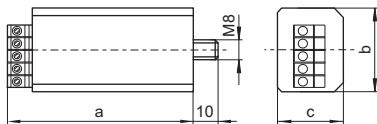

Advantages of PR 12 K LC

- intelligent, auto-adaptive concept
- eliminates the time-consuming task of continually adjusting the times of power-reduced operation to suit constantly changing day-night cycles
- removes the need for making adjustments due to daylight-saving times
- easy programming via dial
- no additional control line necessary
- optimal suitable for the supplementary integration into existing luminaires
- suitable for luminaires of protection class I and II

Type	Ref. No.	Voltage AC V, Hz	Max. contact current		Inherent heating K	Integrated delay switching	Control phase for power reduction (circuitry logic)	Casing			Weight g
			A	λ				a mm	b mm	c mm	
Power reduction with control phase											
PU 12 K	140621	230, 50 / 220, 60	8/0.5	12/1	< 25	–	disconnect or connect	74	34	27	100
PU 120 K	140622*	230, 50 / 220, 60	8/0.5	12/1	< 10	327 sec.	disconnect	74	34	27	100
PU 121 K	140623*	230, 50 / 220, 60	8/0.5	12/1	< 25	327 sec.	connect	74	34	27	100
Power reduction without control phase											
PR 12 K LC****	142170**	220–230 ±10%, 50 220 ±10%, 60	8/0.5	12/1	< 12	selectable	without control phase	76	34	31	100
PR 12 K D****	142150****	220–230 ±10%, 50 220 ±10%, 60	8/0.5	12/1	< 12	selectable	without control phase	76	34	31	100

* For full-load lamp start

** Time of power-reduced operation selectable, starting point of switching-time changes automatically to suit constantly changing day-night cycles

*** Power reduction after a constant switching-time (delay switching); switching-time selectable: 3 | 3.5 | 4 | 4.5 | 5 | 5.5 | 6 hrs at 50 Hz

**** 120–240 V ±10% on request

Electronic Superimposed Ignitors with Power Switch for HS Lamps 50 to 250 W



For ignition and power reduction of high pressure sodium lamps (HS)

Casing: PC

Control voltage: 230 V ±10%

Response/cut-out voltage: 170-198 V

Phasing of the ignition voltage:

60-90 °el and 240-270 °el

Max. permitted casing temperature t_c : 80 °C

Push-in terminals: 0.75-1.5 mm²

Fastening: male nipple with pre-assembled washer and nut

For luminaires of protection class I and II

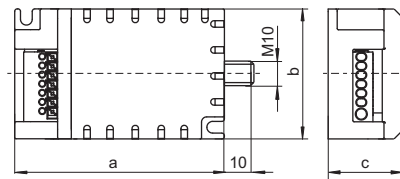

Applicable for positive switch logic allowing for terminal pin assignment of power switch

- Full load lamp start is guaranteed
- Switching to power reduced operation after delay time of approx. 5 min.

Type	Ref. No.	Voltage AC V, Hz	Max. lamp current A	Number of ignition pulses per mains period	Internal loss W	Inherent heating K	Ignition voltage kV	Load capacity pF	Programmed switch-off time sec./Hz	Casing			Weight g
										a	b	c	
HS lamps 50 and 70 W													
ZPU 70 K D20	142098	230, 50/220, 60	2	4	< 2	< 15	1.8-2.3	20-200	1216/50-60	96	50	32	240
HS lamps 70 (DE) to 250 W													
ZPU 250 K D20	142099	230, 50/220, 60	3	6	< 2	< 15	4-5	20-50	1216/50-60	96	50	32	240

Circuit diagrams see page 100

Switch Units for Electronic Operating Devices with 1–10 V Interface

Vossloh-Schwabe's switch units are designed to enable one-step power reduction of lamps (FL, CFL, LED, HS, HI and C-HI) with the help of the respective electronic ballast or converter.

To this end, the switch units utilise the 1–10 V interface of the control gear unit. The switch unit is mainly intended for outdoor luminaires in systems with or without a control phase.

Shape: 56x28x27 mm

Casing: PC

Screw terminals: 0.75–2.5 mm²

Max. permissible casing temperature t_c : 80 °C

Min. permissible ambient temperature t_a : -30 °C

Fastening: plastic male nipple with pre-assembled washer and nut

Power reduction SU 1–10 V K for lighting systems featuring an L_{ST} control phase

The switch unit employs a positive switching to reduce power, i.e. power is reduced when the control phase is switched off ($L_{ST} = 0$ V).

The 1–10 V interface of the electronic ballast is addressed at the moment that power reduction is effected.

Power reduction PR 1–10 V K LC for lighting systems without a control phase

This switch unit can be used to effect power reduction in lighting systems that do not feature a control phase.

The 1–10 V interface is addressed on the basis of the fundamental operating principle used by Vossloh-Schwabe's PR 12 K LC power switch (details of which can be made available on request). This power switch is capable of determining the starting time of reduced-power operation over the measured operating time of a lighting system. As a result, it is no longer necessary to spend valuable time modifying the power-reduction unit to suit the continually changing day-night cycle; changing the clocks in line with daylight saving measures in the summer and winter is equally unnecessary. The 1–10 V interface of the electronic ballast is addressed as soon as the system is switched to reduced power.

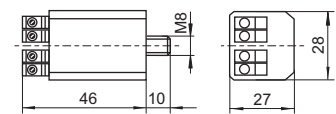

Circuit diagram SU 1–10 V K

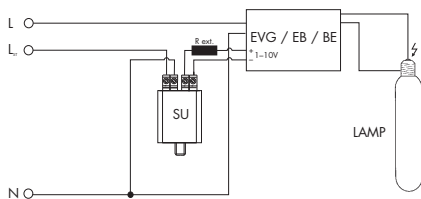

Circuit diagram PR 1–10 V K LC

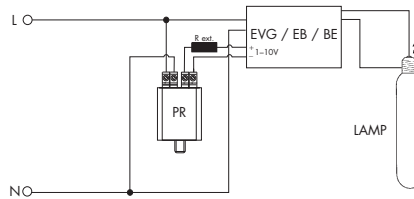

Type	Ref. No.	Control voltage L _{ST} V, 50/60 Hz	Externally (on site) connected resistor (R _{ext.}) kΩ (min. 0.1 W)	Self-heating K	Weight g
For lighting systems with control phase					
SU 1–10 V K	149992	220–240 V ±10%	1–70	< 10	50
For lighting systems without control phase					
PR 1–10 V K LC	149993	–	1–70	< 10	50

Start-up Switches for HS and HI Lamps 35 to 1000 W and HM Lamps 50 to 700 W

To bridge a phase of darkness during the starting-up period of high-pressure discharge lamps and also after a brief interruption of the power supply until the high-pressure discharge lamps are restarted

For mercury vapour lamps (HM), high-pressure sodium lamps (HS), metal halide lamps (HI) and ceramic discharge lamps (C-HI)

For HS, HI and C-HI lamps only if used together with a superimposed ignitor

Nominal voltage/frequency:

220-230 V \pm 10%/50-60 Hz

240 V \pm 10%/50 Hz

Max. permitted casing temperature t_c : 85 °C

Screw terminals: 0.75-2.5 mm²

Fastening: male nipple with pre-assembled washer and nut

Max. wattage of incandescent lamp: 1000 W

Automatic switch-off at 60% of the discharge lamp's luminous flux

During the ignition and start-up period, the start-up switch activates an incandescent lamp to provide a basic level of lighting. After a brief interruption in the supply voltage during the re-ignition of the discharge lamp, the integrated control electronics also bridges the phase of darkness by switching on the auxiliary lighting. The incandescent lamp is automatically switched off when the discharge lamp has achieved a sufficient luminous flux (approx. 60%).

Circuit for HM lamps

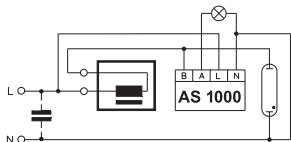

Circuit for HS and HI lamps

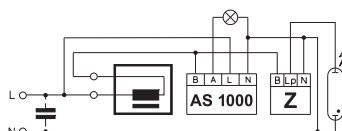

AS 1000 K

Casing: PC

Weight: 100 g

Internal loss: < 0.8 W

Inherent heating: < 10 K

Type: AS 1000 K

Ref. No.: 140627

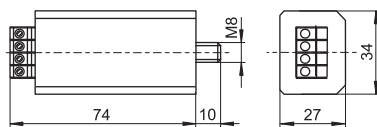

The time diagram shows some typical switching examples of a luminaire equipped with a high-pressure discharge lamp, incandescent lamp and start-up switch AS 1000 K.

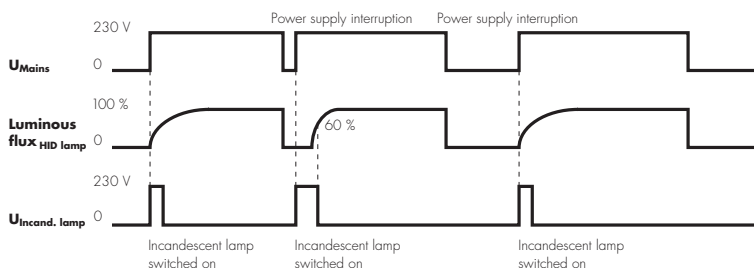

Ignitors and Accessories for Discharge Lamps

AS 1000 K A10

Specially for using with electronic ballasts or pulse ignitors for high-pressure discharge lamps

Casing: PC

Delayed switching: 655 sec. (50 Hz)

For luminaires of protection class I and II

Max. contact current: 6 A at λ 0.5, 10 A at λ 1

Internal loss: < 1 W

Inherent heating: < 12 K

Weight: 100 g

Type: AS 1000 K A10

Ref. No.: 141193

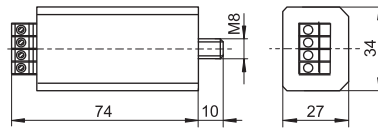

Circuit with electronic ballast

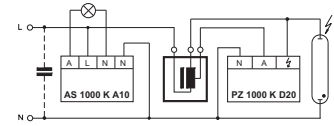
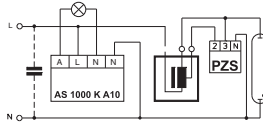
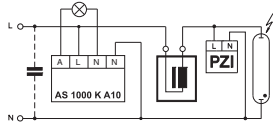
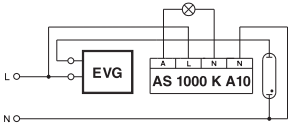

The time diagram shows some typical switching examples of a luminaire equipped with a high-pressure discharge lamp, incandescent lamp and start-up switch AS 1000 K A10.

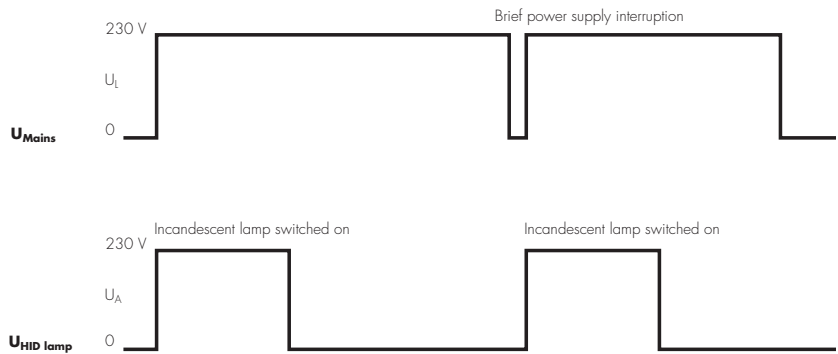

1

2

3

4

5

6

7

8

9

10

Electronic Discharge Units for Parallel Connected Capacitors 0.1 to 100 μF

On luminaires with parallel compensation and designed for plug connection to the mains supply, the plugs retain their charge for a relatively long time after disconnection from the power supply. The discharge resistors built into the compensation capacitor are designed for stationary lamps and when disconnected from the mains permit a voltage reduction to 50 V after 1 minute at the earliest.

According to European standard EN 60598-1, the compensation capacitor on mobile lamps must be discharged to 34 V within 1 second. Until now so-called discharge chokes built like conventional ballasts have been used for this purpose. These conventional discharge chokes are connected in parallel to the compensation capacitor and after disconnection from the power supply rapidly discharge the capacitor owing to their low ohmic resistance.

In their rated operating conditions, conventional discharge chokes exhibit a considerable inductive reactance which diminishes the effect of the compensation capacitor particularly if it has a low capacitance.

Furthermore, conventional discharge chokes cause considerable losses and feature high weight.

With the aid of the electronic discharge unit CE 50, it is possible to discharge a capacitor with a capacitance of up to 100 μF to 34 V within 1 second, i.e. within the time specified in EN 60598-1.

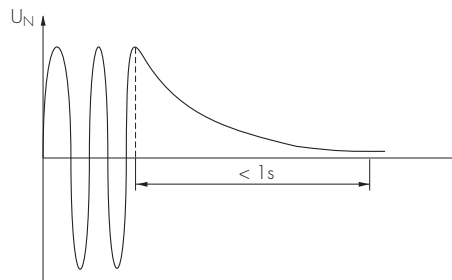

Thanks to its high reliability, low inherent losses, small dimensions and low weight, the CE 50 represents an inexpensive solution to the problem of capacitor discharge.

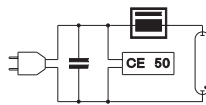

CE 50

All electronic, wear resistant switching element

Casing: aluminium

Nominal voltage: 34–264 V

Nominal frequency: 50–60 Hz

Internal loss: $< 0.5\text{ W}$

Inherent heating: $< 6\text{ K}$

Max. permitted casing temperature: 95 °C

Push-in terminals: 1 mm²

Fastening: male nipple with pre-assembled washer and nut

Weight: 40 g

Type: CE 50

Ref. No.: 140537

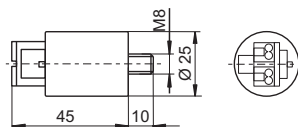

1

2

3

4

5

6

7

8

9

10

THERMOPLASTICS AND PORCELAIN



THE RIGHT MATERIAL MIX SPELLS A DECISIVE ADVANTAGE

The lampholders presented in this chapter are designed for high-pressure discharge lamps, for which high ignition voltages and high starting currents are characteristic. High temperatures can also occur with higher lamp outputs.

Vossloh-Schwabe therefore attaches great importance to ensuring casings, contacts and cables are made of high-grade materials.

Owing to the high ignition voltages, these lampholders are also governed by stricter requirements regarding creepage and air clearance distances.

When operating high-pressure discharge lamps with E27 and E40 Edison bases, care must be taken to ensure that the respective lampholders are approved for use with discharge lamps. Lampholders that are suitable in this respect are marked with "5 kV".

Lampholders with E26 and E39 bases and UL-approved wiring can be found under www.unvlt.com.



E27 lampholders	66–68
E40 lampholders	69–70
G8.5 lampholders	71
GX8.5 lampholders, accessories	71
GU6.5 lampholders	72
PGJ5 lampholders	73
GX10 lampholders	74
GY9.5 lampholders	75
G12, GX12-1, PG12-1, PG12-2 lampholders	75–76
RX7s lampholders	77–80
Fc2 lampholders	80–81
K12x30s lampholders	82
K12s-7 support	82
Technical details for discharge lamps	83–123
General technical details	366–474
Glossary	375–377

E27 Lampholders

For discharge lamps with base E27

E27 lampholders, for cover caps (see p. 310-312)
 Profiled shape, external thread 40x2.5 IEC 60399
 Nominal rating: 4/250/5 kV
 Push-in twin terminals: 0.5-2.5 mm²
 Fixing holes for screws M3
 Rear fixing holes for self-tapping screws
 acc. to ISO 1481/7049-ST3.9-C/F
 Weight: 15/16.5 g, unit: 500 pcs.
 Type: 64719

Ref. No.: 505721 PET GF, black, T210

Ref. No.: 505720 LCP, black, T270

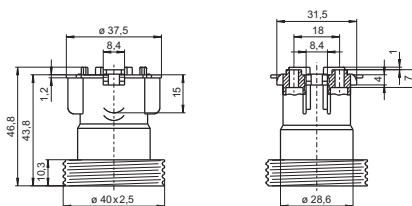

E27 lampholders, for cover caps (see p. 310-312)
 Profiled shape, plain
 Nominal rating: 4/250/5 kV
 Push-in twin terminals: 0.5-2.5 mm²
 Fixing holes for screws M3
 Rear fixing holes for self-tapping screws
 acc. to ISO 1481/7049-ST3.9-C/F
 Weight: 15 g, unit: 500 pcs.
 Type: 64770

Ref. No.: 505389 PET GF, black, T210

Ref. No.: 505014 LCP, black, T270

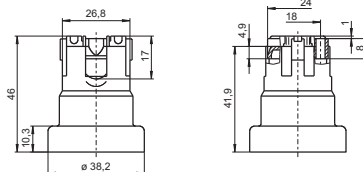

E27 lampholders
 Casing: PPS, black, T230
 Nominal rating: 4/500/5 kV
 Screw terminals: 0.5-2.5 mm²
 Spring loaded central contact
 Fixing holes for screws M4 and M5
 Weight: 35/35.4 g, unit: 250 pcs.
 Type: 62150

Ref. No.: 108718

Type: 62151 with lamp safety catch

Ref. No.: 108719

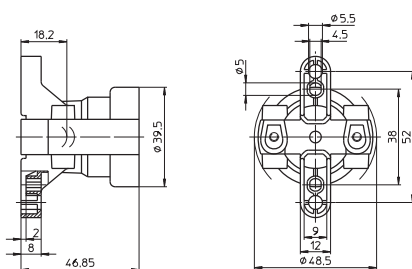

E27 lampholders
 Casing: porcelain, white, T210
 Nominal rating: 4/250/5 kV
 Screw terminals: 0.5-2.5 mm²
 Spring loaded central contact
 Oblong holes for screws M4
 Weight: 65/67.7 g, unit: 200 pcs.
 Type: 62600

Ref. No.: 102635

Type: 62601 with lamp safety catch

Ref. No.: 102637

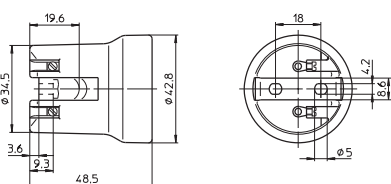

Lampholders for Discharge Lamps

E27 lampholder

Casing: porcelain, white, T210
 Nominal rating: 4/250/5 kV
 Screw terminals: 0.5-2.5 mm²
 Spring loaded central contact
 Threaded bushes for screws M3
 Weight: 69.3 g, unit: 200 pcs.
 Type: 62622

Ref. No.: 108416

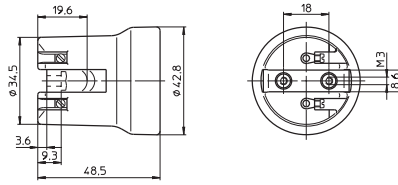

1

2

E27 lampholders

Casing: porcelain, white, T210
 Nominal rating: 4/250/5 kV
 Screw terminals: 0.5-2.5 mm²
 Spring loaded central contact
 Oblong holes for screws M4, length max. 15 mm
 Weight: 106.8/103.9 g, unit: 100 pcs.
 Type: 62104

Ref. No.: 102615

Type: 62105 with lamp safety catch

Ref. No.: 102617

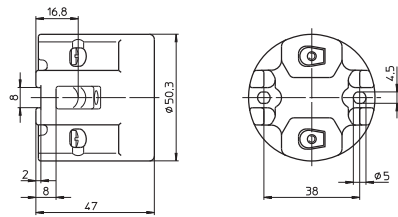

3

4

E27 lampholders

Casing: porcelain, white, T210
 Nominal rating: 4/250/5 kV
 Screw terminals: 0.5-2.5 mm²
 Spring loaded central contact
 Fixing bracket with slot for screws M5
 Weight: 113 g, unit: 100 pcs.
 Type: 62110

Ref. No.: 106585

Type: 62111 with lamp safety catch

Ref. No.: 109568

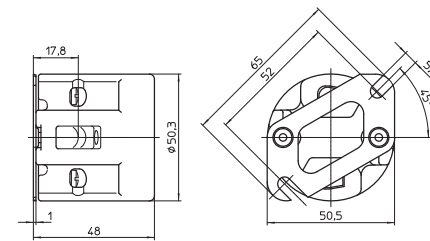

5

6

E27 lampholders

Casing: porcelain, white, T270
 Nominal rating: 4/250/5 kV
 Screw terminals: 0.5-2.5 mm²
 Spring loaded central contact
 Fixing oblong holes for screws M4
 Weight: 60.6 g, unit: 200 pcs.
 Type: 62050

Ref. No.: 102599

Type: 62010 with lamp safety catch (with spring)

Ref. No.: 102577

Type: 62009 with lamp safety catch (with crushing)

Ref. No.: 544605

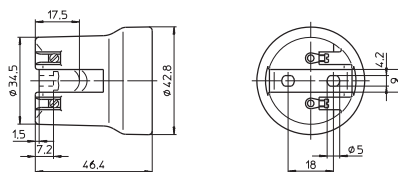

7

8

E27 lampholder

Casing: porcelain, white, T270
 Nominal rating: 4/250/5 kV
 Screw terminals: 0.5-2.5 mm²
 Spring loaded central contact
 Fastening bushes for screws M3
 Weight: 66.3 g, unit: 200 pcs.
 Type: 62015

Ref. No.: 102582

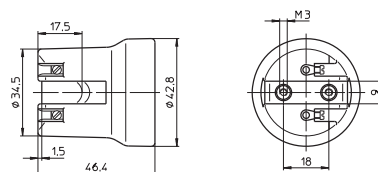

9

10

Lampholders for Discharge Lamps

E27 lampholder, one-piece
 Material: porcelain, white, T270
 Nominal rating: 4/250/5 kV
 Screw terminals: 0.5-2.5 mm²
 Spring loaded central contact
 Fixing oblong holes for screws M4
 Weight: 60.5 g, unit: 200 pcs.
 Type: 62070
Ref. No.: 543304

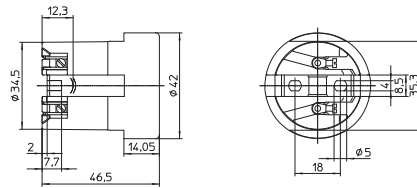

E27 lampholder
 Material: porcelain, white, T270
 Nominal rating: 4/250/5 kV
 Screw terminals: 0.5-2.5 mm²
 With lateral fixing flange,
 tilt angle: 15°
 Spring loaded central contact
 Fixing hole for screw M4
 Weight: 67.6 g, unit: 200 pcs.
 Type: 62415
Ref. No.: 543414

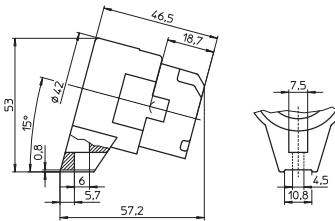

E27 lampholder, for cover caps (see page 310-312)
 Casing: porcelain, white, T270
 Nominal rating: 4/250/5 kV
 Screw terminals: 0.5-2.5 mm²
 Spring loaded central contact
 Fixing oblong holes for screws M4
 Weight: 66.5 g, unit: 150 pcs.
 Type: 62310
Ref. No.: 102624

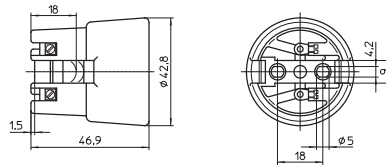

E27 lampholder
 For cover caps type 80010, 97735
 and 97742 (see page 318)
 Casing: porcelain, white, T270
 Nominal rating: 4/250/5 kV
 Screw terminals: 0.5-2.5 mm²
 Spring loaded central contact
 Fixing oblong holes for screw M4
 Weight: 66.5 g, unit: 200 pcs.
 Type: 62370
Ref. No.: 543303

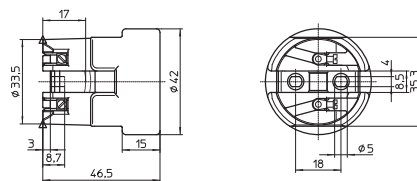

E40 Lampholders

For discharge lamps with base E40

Nominal rating: 18/500/5 kV

Screw terminals: 1.5–4 mm²

Spring loaded central contact

E40 lampholders

Casing: PPS, black, T240

Oblong holes for screws M5

Weight: 111.7/112.1 g, unit: 40 pcs.

Type: 12600/12601

Ref. No.: 400913

Ref. No.: 400914 with lamp safety catch

With steel thread

Ref. No.: 533428

Ref. No.: 533429 with lamp safety catch

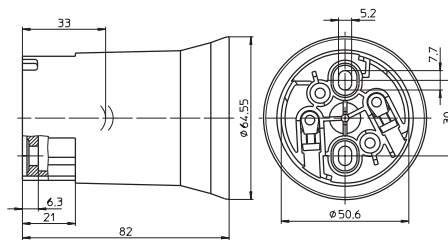

E40 lampholders

Casing: PPS, black, T240

Fixing bracket with slots for screws M5

Weight: 122.3/122.7 g, unit: 40 pcs.

Type: 12610/12611

Ref. No.: 400915

Ref. No.: 400916 with lamp safety catch

With steel thread

Ref. No.: 533430

Ref. No.: 533431 with lamp safety catch

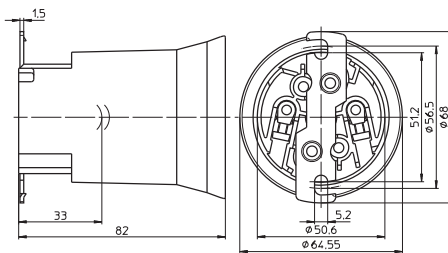

E40 lampholders

Casing: PPS, black, T240

Fixing bracket with tapped fixing holes M5

Weight: 122.9/123.3 g, unit: 40 pcs.

Type: 12614/12612

Ref. No.: 400917

Ref. No.: 400918 with lamp safety catch

With steel thread

Ref. No.: 536220

Ref. No.: 533432 with lamp safety catch

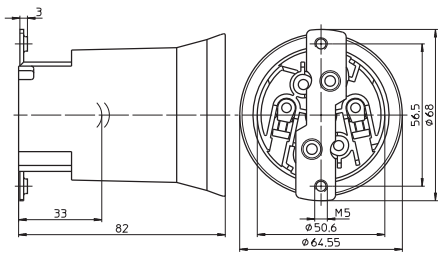

E40 lampholders

Casing: porcelain, white, T270

Oblong holes for screws M5

Weight: 224/229.3 g, unit: 48 pcs.

Type: 12800/12801

Ref. No.: 108208

Ref. No.: 107780 with lamp safety catch

With steel thread

Ref. No.: 532602

Ref. No.: 532603 with lamp safety catch

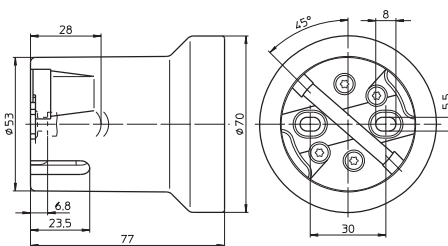

Lampholders for Discharge Lamps

E40 lampholders

Casing: porcelain, white, T270

Fixing bracket with slots for screws M5

Weight: 252.3/243 g, unit: 48 pcs.

Type: 12810/12811

Ref. No.: 108374

Ref. No.: 108375 with lamp safety catch

With steel thread

Ref. No.: 532604

Ref. No.: 532605 with lamp safety catch

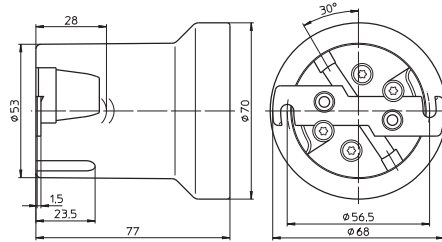

E40 lampholders

Casing: porcelain, white, T270

Fixing bracket with tapped fixing holes M5

With lamp safety catch

Weight: 252.8 g, unit: 48 pcs.

Type: 12812

Ref. No.: 108373

With steel thread

Ref. No.: 532606

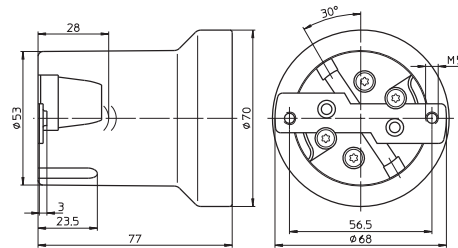

E40 lampholders

Only for lamps with base E40/E45

Casing: porcelain, white, T270

Oblong holes for screws M5

Weight: 206 g, unit: 50 pcs.

Type: 12900/12901

Ref. No.: 528252

Ref. No.: 528958 with lamp safety catch

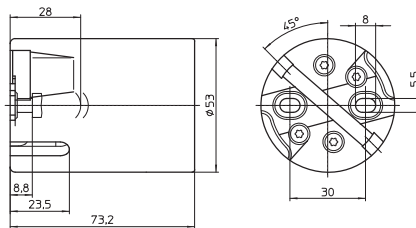

E40 lampholders

Only for lamps with base E40/E45

Casing: porcelain, white, T270

Fixing bracket with slots for screws M5

Weight: 217 g, unit: 50 pcs.

Type: 12910/12911

Ref. No.: 528253

Ref. No.: 528254 with lamp safety catch

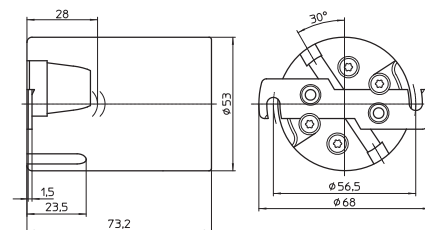

G8.5 Lampholders

For discharge lamps with base G8.5

Nominal rating: 2/500/5 kV

Multipoint contacts: CuNiZn

Fixing holes for screws M3

G8.5 lampholders

Push-in terminals for stranded conductors with ferrule bare end of cores \varnothing 1.4-1.8 mm

Type: 33600 casing: LCP, black, T260

Weight: 5 g, unit: 1000 pcs.

Ref. No.: 502394

Type: 33650 casing: ceramic, T300

Weight: 12.6 g, unit: 150 pcs.

Ref. No.: 554542

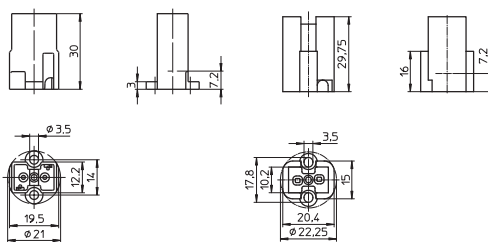

G8.5 lampholder

Casing: ceramic, T300

Welded leads: Cu tinned, stranded conductors 1 mm²,

Si-insulation max. \varnothing 3.6 mm, length: 300 mm

Weight: 26.4 g, unit: 100 pcs.

Type: 33671

Ref. No.: 554543

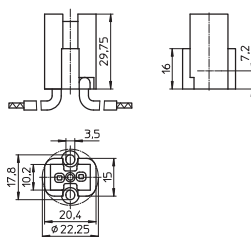

GX8.5 Lampholders, Accessories

For discharge lamps with base GX8.5

GX8.5 lampholders

Casing: LCP, cover material: LCP, T260

Nominal rating: 2/500/5kV

Push-in terminals for stranded conductors

with ferrule bare end of cores \varnothing 1.8 mm

Weight: 11.9/12.6, unit: 50 pcs.

Type: 34650/34651

Ref. No.: 547807 fixing holes for screws M3

Ref. No.: 547808 threaded bushes M3

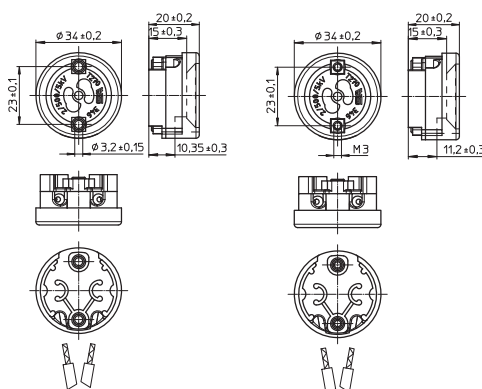

Cover cap for GX8.5 lampholders type 346

For luminaires of protection class II

Material: LCP, black

Weight: 5.4 g, unit: 50 pcs.

Type: 97685

Ref. No.: 532521

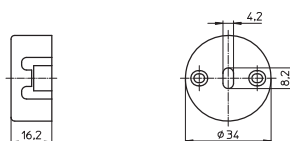

GU6.5 Lampholders

For discharge lamps with base GU6.5

Suitable for luminaries of protection class II

Casing: ceramic, cover: PPS, T250

Nominal rating: 2/250/5 kV

Leads: Cu nickel-plated, stranded conductors 0.75 mm²,
double PTFE-insulation, length: 250 mm

GU6.5 lampholders

Weight: 13.8 g, unit: 100 pcs.

Type: 34510 fixing holes for screws M3

Ref. No.: 533957

Type: 34511 threaded bushes for screws M3

Ref. No.: 534220

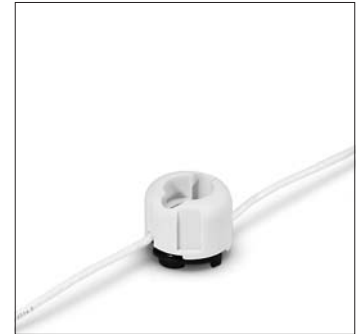
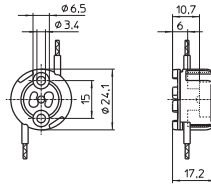

GU6.5 lampholder

Fixing holes for screws M3

Identical mounting hole layout and lamp focus of the PGJ5 lampholder 34120 offer an effortless interchangeability of both lamp technologies.

Weight: 15 g, unit: 100 pcs.

Type: 34520

Ref. No.: 539497

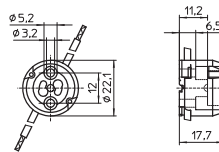

PGJ5 Lampholders

For discharge lamps with base PGJ5

Nominal rating: 2/300/2.5 kV

Fixing holes for screws M3

PGJ5 lampholders with cover plate

Casing: ceramic, cover plate: LCP, T270

Leads: Cu nickel-plated, stranded conductors

0.75 mm², PTFE-insulation, length: 250 mm

Weight: 9.2 g, unit: 100 pcs.

Type: 34105/34106

Ref. No.: 534080 lateral lead exit

Ref. No.: 534081 central lead exit

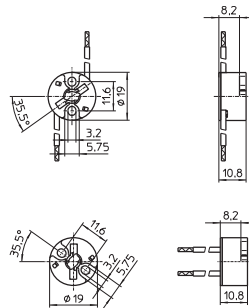

PGJ5 lampholders with cover plate

Suitable for luminaires protection class II

Casing: ceramic, cover plate: LCP, T270

Leads: Cu nickel-plated, stranded conductors

0.75 mm², double PTFE-insulation, length: 250 mm

Weight: 10.6 g, unit: 100 pcs.

Type: 34110/34111

Ref. No.: 534016 lateral lead exit

Ref. No.: 534017 central lead exit

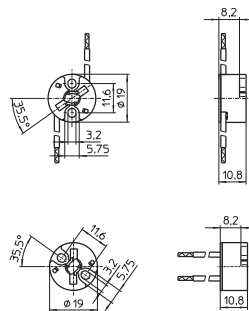

PGJ5 lampholders with cover plate

Suitable for luminaires protection class II

Casing: ceramic, cover plate: mica, T270

Leads: Cu nickel-plated, stranded conductors

0.75 mm², double PTFE-insulation, length: 250 mm

Weight: 10.8 g, unit: 100 pcs.

Type: 34150/34151

Ref. No.: 536428 lateral lead exit

Ref. No.: 536429 central lead exit

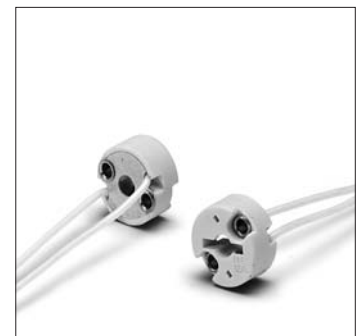
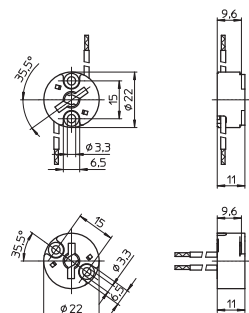

1

2

3

4

5

6

7

8

9

10

GX10 Lampholders

For discharge lamps with base GX10

GX10 lampholder, for luminaires of protection class II
 Casing: PPS, black, T240, nominal rating: 2/250/5 kV
 Push-in twin terminals for stranded conductors
 with ferrule bare end of cores max. \varnothing 1.8 mm
 Fixing holes for screws M3
 Weight: 9 g, unit: 100 pcs.. Type: 31400
Ref. No.: 509356

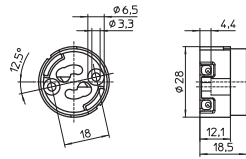

GX10 lampholder, for luminaires of protection class II
 Casing: steatite, cover plate: PPS
 T240, nominal rating: 2/500/5 kV
 Push-in terminals for stranded conductors
 with ferrule bare end of cores \varnothing 1.5–1.8 mm
 For leads with outer diameter: max. 3 mm
 Fixing holes for screws M3
 Weight: 14 g, unit: 100 pcs.
 Type: 31500

Ref. No.: 536469

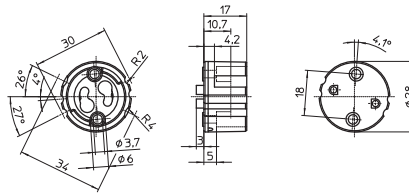

GX10 lampholder
 Casing: steatite, cover plate: PPS
 T240, nominal rating: 2/500/5 kV
 Welded leads: 2x0.75 mm², stranded conductors,
 length: 400 mm
 5 kV: Cu nickel-plated, PTFE-insulation,
 Cu tinned, Si-insulation
 Fixing holes for screws M3
 Weight: 36.3 g, unit: 100 pcs.
 Type: 31500

Ref. No.: 549999

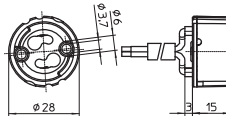

GX10 lampholder, for luminaires of protection class II
 Casing: steatite, cover plate: PPS
 T240, nominal rating: 2/500/5 kV
 Welded leads: Cu nickel-plated, stranded conductors
 0.75 mm², double PTFE-insulation, length: 250 mm
 Fixing holes for screws M3
 Weight: 23.3 g, unit: 100 pcs.
 Type: 31530
Ref. No.: 543267

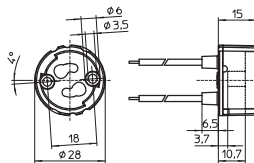

GY9.5 Lampholders

For discharge lamps with base GY9.5

GY9.5 lampholder

Casing: ceramic, cover plate: PPS, black

T240, nominal rating: 10/500/5 kV, contacts: Ni

Leads: Cu tinned, stranded conductors

5 kV: 1 mm², Si-insulation max. Ø 3.6 mm,

length: 300 mm and Cu tinned,

stranded conductors 0.75 mm², Si-insulation,

length: 300 mm

Fixing holes for screws M3

Weight: 48 g, unit: 150 pcs.

Type: 37001

Ref. No.: 533663

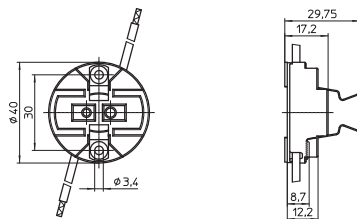

1

2

3

4

G12, GX12-1, PG12-1, PG12-2 Lampholders

For discharge lamps with base G12, GX12 and PG12

G12 lampholders

Casing: ceramic, cover plate: LCP

T250, nominal rating: 5/500/5 kV

Contacts: CrNi

Push-in terminals for leads with

ferrule bare end of cores max. Ø 1.8 mm

Weight: 30.7 g, unit: 25 pcs.

Type: 42200/42210

Ref. No.: 535750 fixing holes Ø 4.2 mm

Ref. No.: 535751 threaded bushes M3

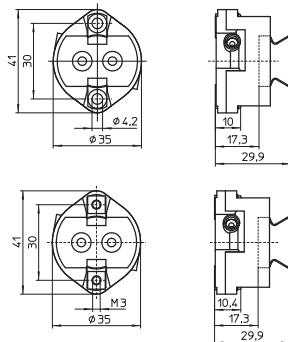

5

6

G12 lampholders

Casing: ceramic

T250, nominal rating: 5/500/5 kV

Contacts: CrNi

Welded leads: Cu tinned, stranded conductors 1 mm²

Si-insulation, white, length: 300 mm

Weight: 43/52 g, unit: 25 pcs.

Type: 42222/42242

Ref. No.: 535755 cover plate: LCP

Ref. No.: 543643 cover plate: ceramic

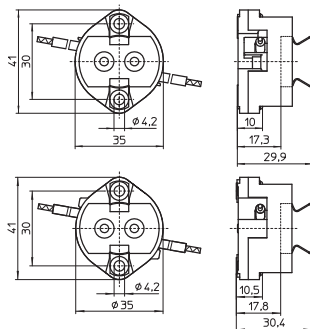

7

8

G12 lampholder

Casing: LCP, black

T250, nominal rating: 2/500/5 kV

Contacts: CrNi

Push-in terminals for leads with

ferrule bare end of cores max. Ø 1.8 mm

For tinned lead ends: 0.5 - 1 mm²

Fixing holes for screws M4

Weight: 13.6 g, unit: 250 pcs.

Type: 42000

Ref. No.: 509213

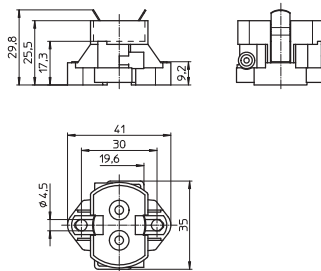

9

10

Lampholders for Discharge Lamps

GX12-1 lampholder

Casing: ceramic, cover plate: PPS, black
 T220, nominal rating: 2/500/5 kV, contacts: Ni
 Welded leads: Cu tinned, stranded conductors
 5 kV: 1 mm², Si-insulation, white,
 N: 0.75 mm², Si-insulation, brown,
 length: 300 mm

Fixing holes for screws M4
 Weight: 58.5 g, unit: 25 pcs.
 Type: 41900

Ref. No.: 507656

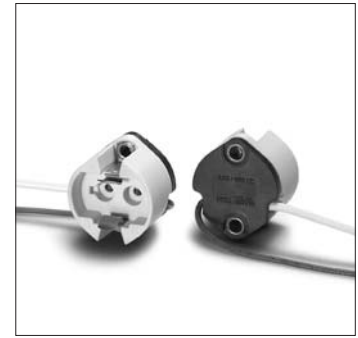
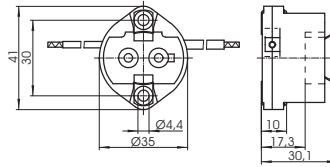

GX12-1 lampholder

Casing: LCP, black
 T250, nominal rating: 2/500/5 kV
 Contacts: CrNi

Push-in terminals for leads with
 ferrule on bare end of core max. Ø 1.8 mm
 or for tinned lead ends: 0.5-1 mm²

Fixing holes for screws M4
 Weight: 13.6 g, unit: 50 pcs.
 Type: 42100

Ref. No.: 509214

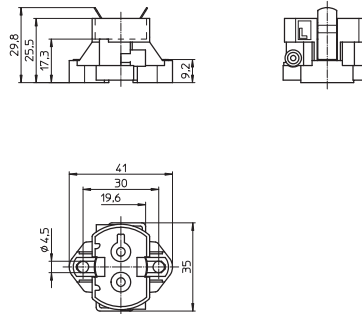

PG12-1 lampholder

Casing: PPS, black, T220
 Nominal rating: 4/500/5 kV, contacts: CrNi
 Push-in terminals for leads with
 ferrule on bare end of core max. Ø 1.8 mm
 or for tinned lead ends: 0.5-1 mm²

Fixing holes for screws M4
 Weight: 20.2 g, unit: 100 pcs.
 Type: 31981

Ref. No.: 505030

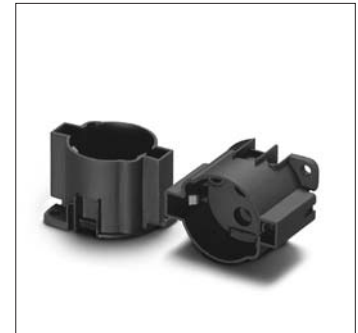
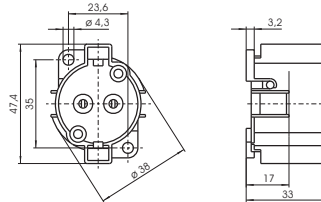

PG12-1 lampholder

For cover caps (see p. 310-312)
 Casing: PPS, black, T220
 Nominal rating: 4/500/5 kV, contacts: CrNi
 Push-in terminals for leads with
 ferrule on bare end of core max. Ø 1.8 mm
 or for tinned lead ends: 0.5-1 mm²

Fixing holes for screws M3
 Weight: 23 g, unit: 100 pcs.
 Type: 31980

Ref. No.: 505029

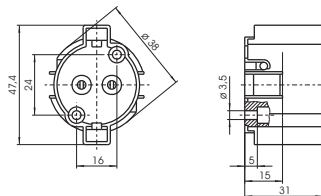

RX7s Lampholders

If the central hole on the bracket is used for fixing it has to be ensured by an additional support within the luminaire that the bracket cannot be deformed. If the lampholders are used for lamps with ignition voltage max. 20 kV the luminaire manufacturer is responsible for sufficient creepage distances and clearances.

RX7s lampholders

Contact pin: Ni, nominal rating: 2/500/5 kV
 Lead: Cu tinned, stranded conductors 1 mm²,
 Si-insulation max. Ø 3.6 mm, length: 300 mm
 Fixing holes for screws M4
 Weight: 23.3/20.1 g, unit: 25 pcs.
 Type: 31662/31672 PPS, black, T220
Ref. No.: 107065 lead exit right
Ref. No.: 107066 lead exit left
 Type: 31695/31696 LCP, black, T260
Ref. No.: 504416 lead exit right
Ref. No.: 504669 lead exit left

Remark on lampholders type 323 and 343:

The luminaire design must ensure protection from electric shock as well as sufficient creepage distances and clearances from live parts on the back of lampholder.

Type 343:

With doubled insulated leads suitable for luminaires of protection class II

RX7s lampholder

Casing: PPS, black, T220
 Contact pin: Cu, silver bulb
 Nominal rating: 2/250/5 kV
 Lead: Cu tinned, stranded conductors 1 mm²,
 Si-insulation max. Ø 3.6 mm, length: 200 mm
 With screw M4
 Weight: 14 g, unit: 300 pcs.
 Type: 34301
Ref. No.: 509117

RX7s lampholder

Casing: PPS, black, T220
 Contact pin: Cu, silver bulb
 Nominal rating: 2/250/5 kV
 Leads: Cu tinned, stranded conductors 1 mm²,
 Si-insulation max. Ø 3.6 mm, length: 200 mm
 Oblong holes for screws M4
 Central hole for screw M4
 Other bracket versions on request
 Weight: 43.8 g, unit: 200 pcs.
 Type: 34311 contact distance 114.2 mm
Ref. No.: 529841

RX7s lampholder

Casing: PPS, black, T220
 Contact pin: Cu, silver bulb
 Nominal rating: 2/250/5 kV
 Leads: Cu tinned, stranded conductors 1 mm²,
 Si-insulation max. Ø 3.6 mm, length: 200 mm
 Oblong holes for screws M4
 Central tapped hole M4
 Weight: 47.5 g, unit: 200 pcs.
 Type: 34326 contact distance: 132 mm
Ref. No.: 529845

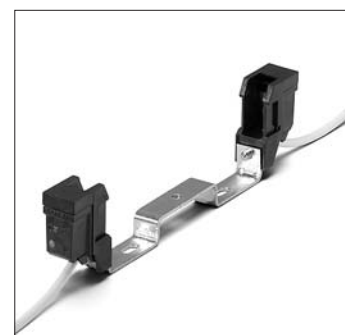
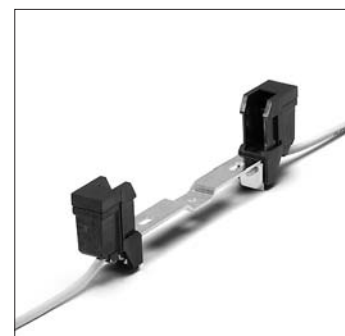
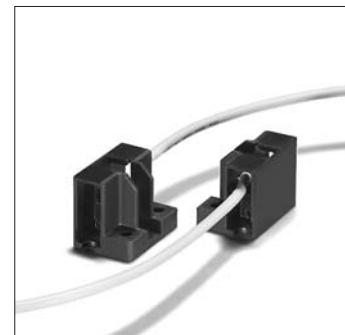
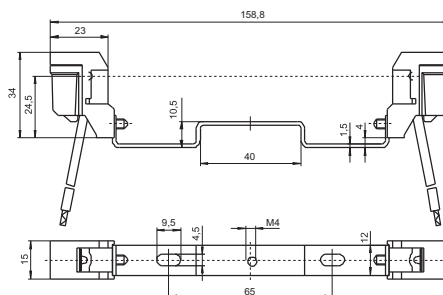
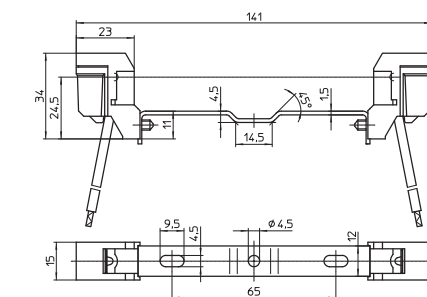
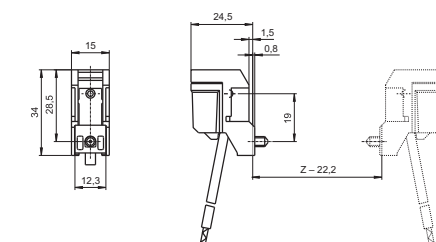
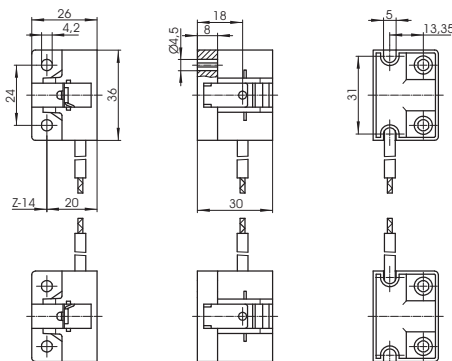

1

2

3

4

5

6

7

8

9

10

Lampholders for Discharge Lamps

Partly enclosed RX7s lampholder

Casing: ceramic, T350

Contact pin: Cu, silver bulb

Nominal rating: 4/500/5 kV

Lead: Cu tinned, stranded conductors 1 mm²,

Si-insulation max. Ø 3.6 mm, length: 200 mm

Fixing screw M4

Weight: 26.2 g, unit: 300 pcs.

Type: 32301

Ref. No.: 100913

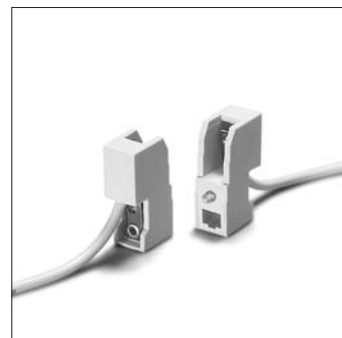
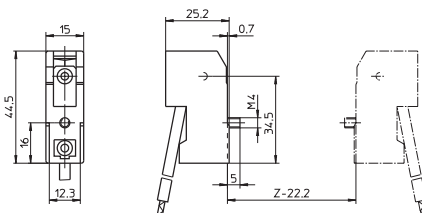

Partly enclosed RX7s lampholder

Casing: ceramic, T350

Contact pin: Cu, silver bulb

Nominal rating: 4/500/5 kV

Leads: Cu tinned, stranded conductors 1 mm²,

Si-insulation max. Ø 3.6 mm, length: 200 mm

Oblong holes for screws M4

Central hole for screw M4

Weight: 74.8 g, unit: 200 pcs.

Type: 32311 contact distance: 114.2 mm

Ref. No.: 100921

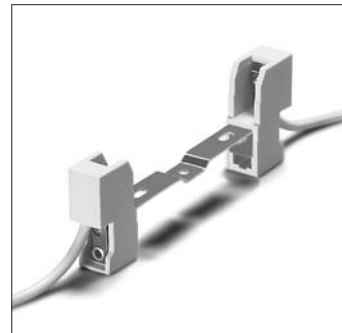
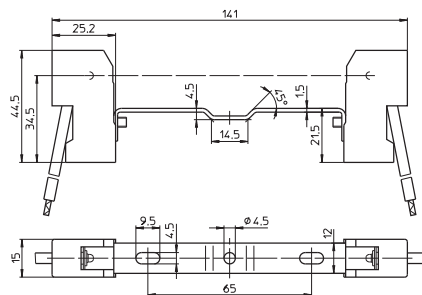

Partly enclosed RX7s lampholder

Casing: ceramic, T350

Contact pin: Cu, silver bulb

Nominal rating: 4/500/5 kV

Leads: Cu tinned, stranded conductors 1 mm²,

Si-insulation max. Ø 3.6 mm, length: 200 mm

Oblong holes for screws M4

Central tapped holes M4

Weight: 76 g, unit: 200 pcs.

Type: 32321 contact distance: 114.2 mm

Ref. No.: 100922

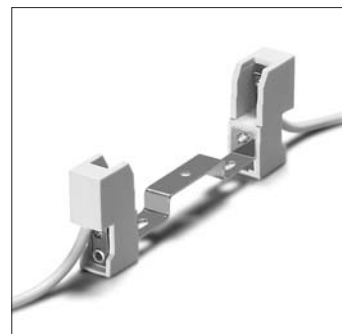
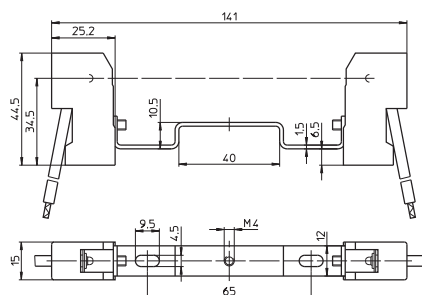

Partly enclosed RX7s lampholder

Casing: ceramic, T350

Contact pin: Cu, silver bulb

Nominal rating: 4/500/5 kV

Leads: Cu tinned, stranded conductors 1 mm²,

Si-insulation max. Ø 3.6 mm, length: 200 mm

Oblong holes for screws M4

Central hole for screw M4

Weight: 74 g, unit: 200 pcs.

Type: 32341 contact distance: 114.2 mm

Ref. No.: 100932

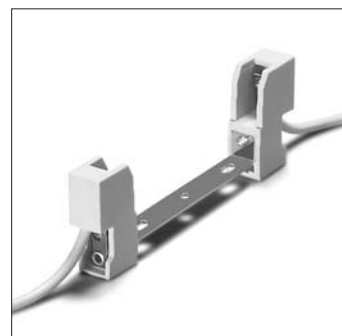
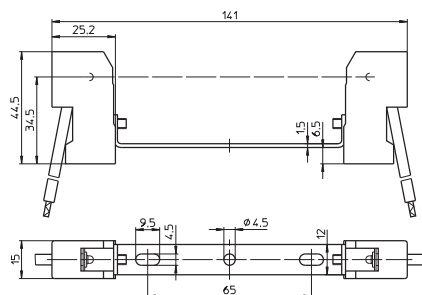

Partly enclosed RX7s lampholder

Casing: ceramic, T350

Contact pin: Cu, silver bulb

Nominal rating: 4/500/5 kV

Leads: Cu tinned, stranded conductors 1 mm²,

Si-insulation max. Ø 3.6 mm, length: 200 mm

Oblong holes for screws M4

Central hole for screw M5

Weight: 75.5 g, unit: 200 pcs.

Type: 32361 contact distance: 114.2 mm

Ref. No.: 100934

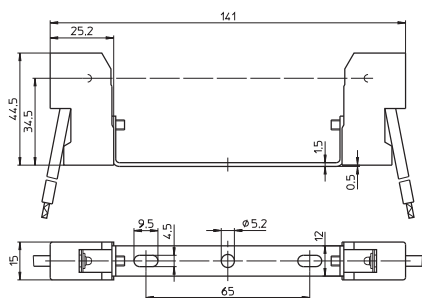

Lampholders for Discharge Lamps

Partly enclosed RX7s lampholder

Casing: ceramic, T350

Contact pin: Cu, silver bulb

Nominal rating: 4/500/5 kV

Leads: Cu tinned, stranded conductors 1 mm²,

Si-insulation max. Ø 3.6 mm, length: 200 mm

Oblong holes for screws M4

Central hole for screw M5

Weight: 76.4 g, unit: 200 pcs.

Type: 32381 contact distance: 114.2 mm

Ref. No.: 100937

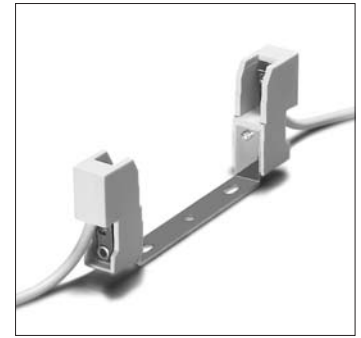
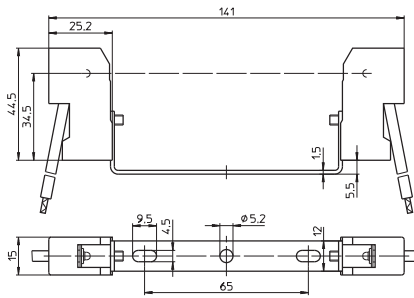

1

2

Partly enclosed RX7s lampholder

Casing: ceramic, T350

Contact pin: Cu, silver bulb

Nominal rating: 4/500/5 kV

Leads: Cu tinned, stranded conductors 1 mm²,

Si-insulation max. Ø 3.6 mm, length: 200 mm

Oblong holes for screws M4

Central tapped hole M4

Weight: 78.3 g, unit: 200 pcs.

Type: 32326 contact distance: 132 mm

Ref. No.: 100925

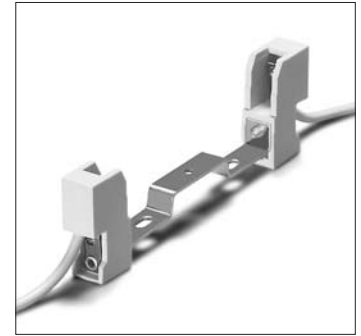
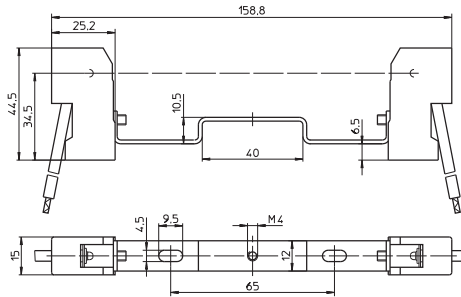

3

4

Partly enclosed RX7s lampholder

Casing: ceramic, T350

Contact pin: Cu, silver bulb

Nominal rating: 4/500/5 kV

Leads: Cu tinned, stranded conductors 1 mm²,

Si-insulation max. Ø 3.6 mm, length: 200 mm

Oblong holes for screws M4

Central hole for screw M5

Weight: 77.6 g, unit: 200 pcs.

Type: 32330 contact distance: 132 mm

Ref. No.: 100928

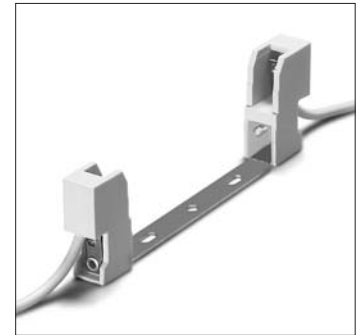
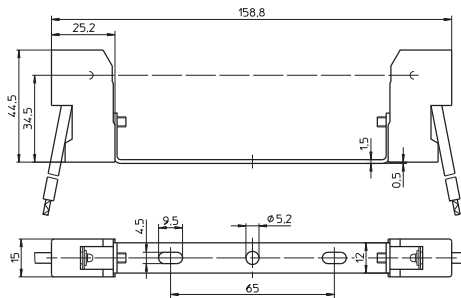

5

6

Partly enclosed RX7s lampholder

Casing: ceramic, T350

Contact pin: Cu, silver bulb

Nominal rating: 4/500/5 kV

Leads: Cu tinned, stranded conductors 1 mm²,

Si-insulation max. Ø 3.6 mm, length: 200 mm

Oblong holes for screws M4

Central hole for screw M5

Weight: 75.7 g, unit: 200 pcs.

Type: 32336 contact distance: 132 mm

Ref. No.: 100931

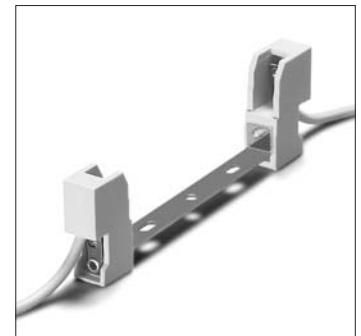
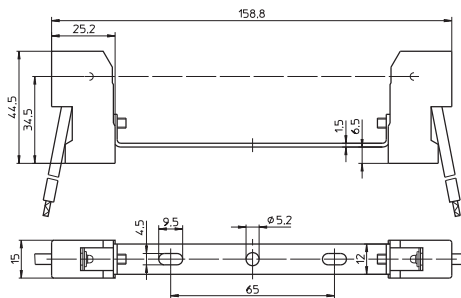

7

8

Protection caps for RX7s lampholders

For push-fit onto lampholders type 323

Protection against electrical shock

on the rear side of the lampholder

Lampholders with assembled protection cap

on request

Weight: 0.7/0.6 g, unit: 1000 pcs.

Type: 97528

Ref. No.: 507592 LCP, natural

Ref. No.: 507593 PET, white

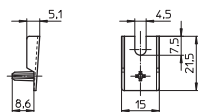

9

10

Lampholders for Discharge Lamps

RX7s lampholder

Casing: ceramic, T250

Contact pin: Ni

Nominal rating: 10/500/5 kV

Lead: Cu tinned, stranded conductors 1 mm²,

Si-insulation max. Ø 3.6 mm, length: 300 mm

Fixing holes for screws M4

Weight: 72 g, unit: 25 pcs.

Type: 30602

Ref. No.: 100723

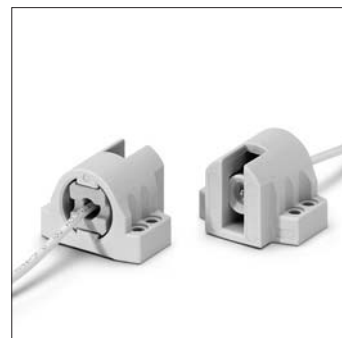
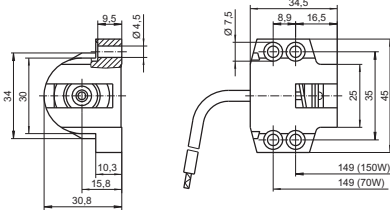

RX7s lampholder

Casing: ceramic, T250, contact pin: Ni

Nominal rating: 10/500/20 kV

Lead: Cu tinned, stranded conductors 1 mm²,

Si-insulation with spun glass filler Ø 7 mm,
for ignition voltage: max. 20 kV,
length: 1000 mm

Fixing holes for screws M4

Weight: 120 g, unit: 25 pcs.

Type: 30620

Ref. No.: 100741

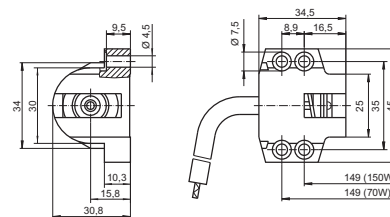

Fc2 Lampholders

For discharge lamps with base Fc2

If the lampholders are used for lamps with ignition voltage max. 20 kV the luminaire manufacturer is responsible for sufficient creepage distances and clearances.

Fc2 lampholder

Casing: ceramic, T250

Nominal rating: 10/500/5 kV

Contacts: Ni

Lead: Cu tinned, stranded conductors 1 mm²,

Si-insulation max. Ø 3.6 mm, length: 300 mm

Fixing holes for screws M4

Weight: 100 g, unit: 200 pcs.

Type: 02500

Ref. No.: 108937

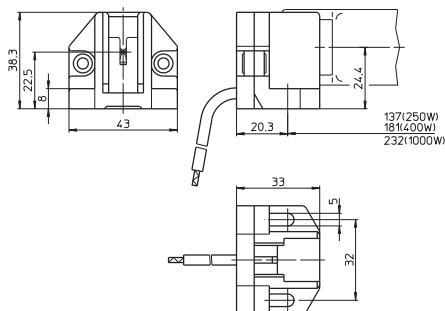

Fc2 lampholder

Casing: ceramic, T250

Nominal rating: 10/500/5 kV, contacts: Ni

Lead: Cu tinned, stranded conductors 1 mm²,

Si-insulation max. Ø 3.6 mm, length: 300 mm

Fixing screws M4, captive

Weight: 102 g, unit: 25 pcs.

Type: 02574 rigid fixing

Ref. No.: 100096

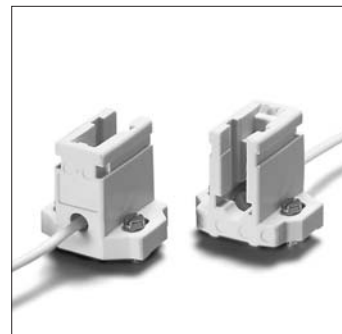
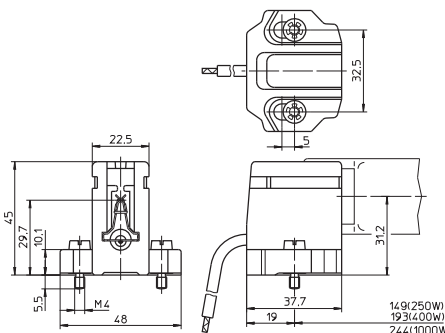

Lampholders for Discharge Lamps

Fc2 lampholder

Casing: ceramic, T250
 Nominal rating: 10/500/5 kV, contacts: Ni
 Lead: Cu tinned, stranded conductors 1 mm²,
 Si-insulation max. Ø 3.6 mm, length: 300 mm
 Fixing screws M4, captive
 Weight: 102 g, unit: 25 pcs.
 Type: 02575 adjustable fixing
Ref. No.: 100098

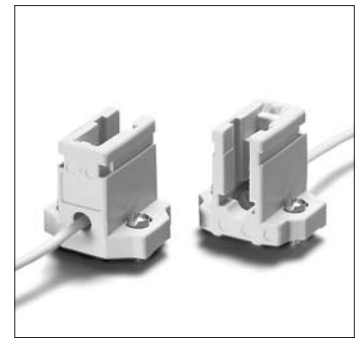
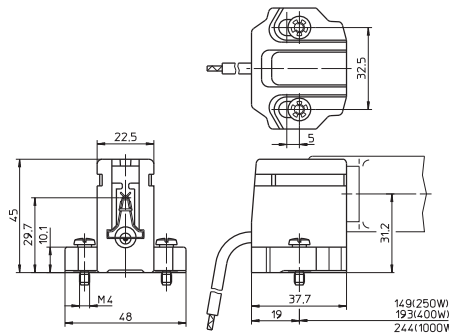

1

2

Fc2 lampholder

Casing: ceramic, T250
 Nominal rating: 10/500/20 kV, contacts: Ni
 Lead: Cu tinned, stranded conductors 1 mm²,
 Si-insulation with spun glass filler Ø 7 mm,
 for ignition voltage: max. 20 kV,
 length: 500 mm
 Fixing screws M4, captive
 Weight: 120 g, unit: 25 pcs.
 Type: 02525 rigid fixing
Ref. No.: 100082

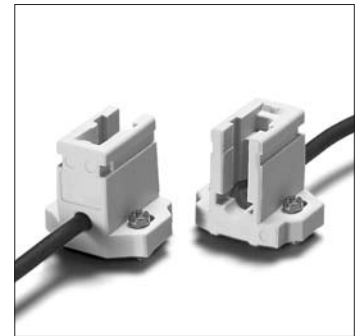
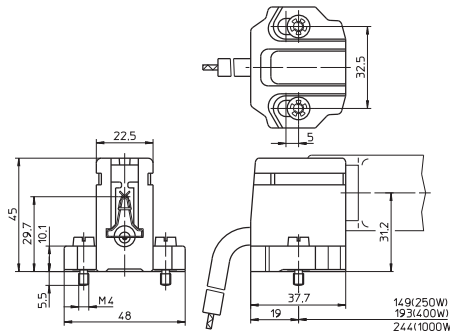

3

4

Fc2 lampholder

Casing: ceramic, T250
 Nominal rating: 10/500/20 kV, contacts: Ni
 Lead: Cu tinned, stranded conductors 1 mm²,
 Si-insulation with spun glass filler Ø 7 mm,
 for ignition voltage: max. 20 kV,
 length: 500 mm
 Fixing screws M4, captive
 Weight: 120 g, unit: 25 pcs.
 Type: 02543 adjustable fixing
Ref. No.: 100086

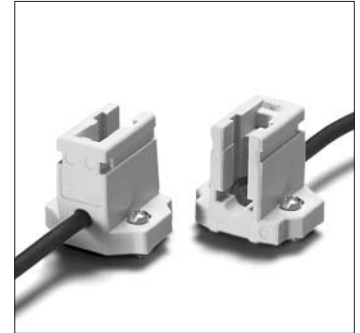
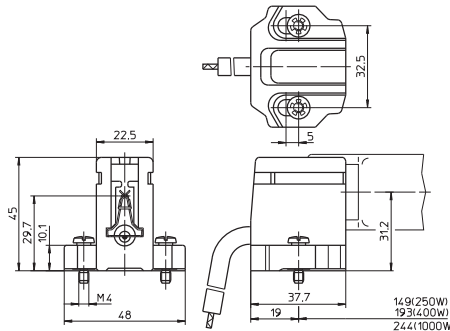

5

6

Lamp safety catch

For push-fit onto the lampholders 100082,
 100086, 100096 and 100098
 Casing: ceramic
 Spring: stainless steel
 Weight: 21 g, unit: 50 pcs.
 Type: 86037
Ref. No.: 103818

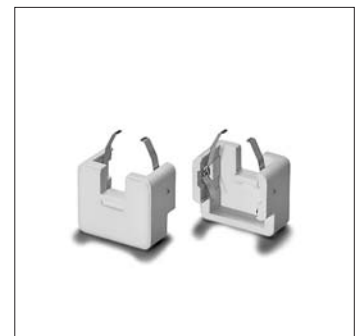
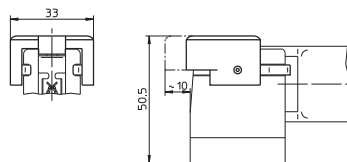

7

8

9

10

K12x30s Lampholders

For discharge lamps with base K12x30s

K12x30s lampholders

Suitable for luminaires of protection class II

Casing: LCP, black, T150

Nominal rating: 4/500/3 kV

Contacts: CuSn6, silver plated

Leads: Cu tinned, stranded conductors 1 mm²

Si-insulation, doubled insulated

Rear recess M4, wrench size 7

Rear and bottom fixing holes for screws M5

Weight: 75.9/61.5 g, unit: 100 pcs.

Type: 13010

Ref. No.: 532430 lead length: 705 mm

Ref. No.: 532431 lead length: 155 mm

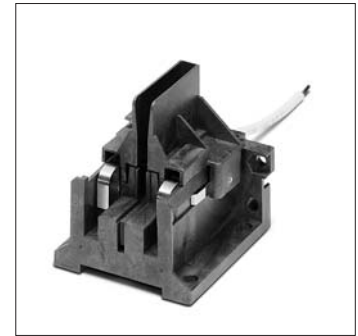
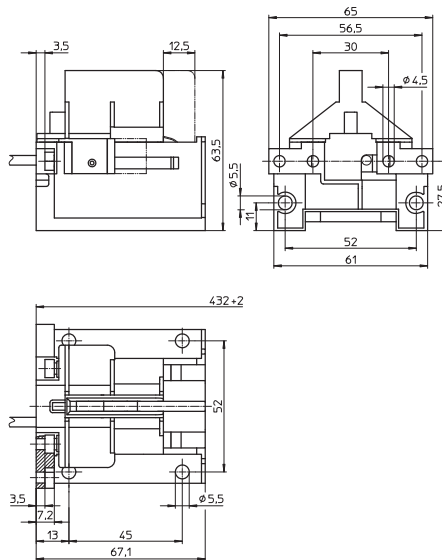

K12s-7 Support

For metal halide lamps 1000 and 2000 W

Type Osram HQI TS and Radium HRI TS

The luminaire design must ensure protection from electric shock as well as sufficient creepage and clearance distances.

K12s-7 support

Cable connection on cable lug for lead 0.75-2.5 mm²

Casing: ceramic, T300

Support: stainless steel, heat-resistant

Oblong holes for screws M5

Weight: 70 g, unit: 25 pcs.

Type: 21100

Ref. No.: 107677

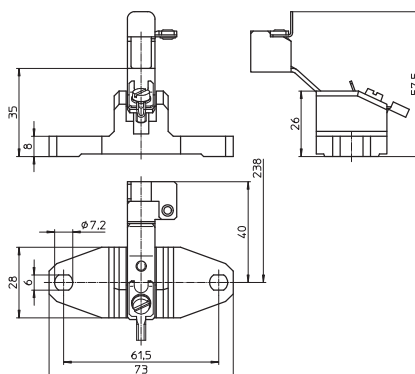

2

Components for Discharge Lamps

Electronic ballasts	84
Assembly instructions for mounting and installing	85-98
Circuit diagrams	89
Electromagnetic ballasts	89
Power reduction	90
Assembly instructions for mounting and installing	94-97
Electromagnetic control gear units	91
Assembly instructions for mounting and installing	91-94
Circuit diagrams – Electromagnetic ballasts	98-100
Lampholders for high-pressure discharge lamps	101-102
Ignitors	102-104
Assembly instructions for mounting and installing	105-107
Power switches	108-110
Switch units	110-111
Lamp table	112-122
Energy efficiency classification	123
General technical details	366-374
Glossary	375-377

1

2

3

4

5

6

7

8

9

10

If the electrical current through a discharge lamp is increased, a discharge channel with very high luminous efficiency is created in the discharge chamber. Luminous flux and light output increase substantially. The internal pressure of the discharge chamber rises and attains between 1 and 10 bar – these are so-called high-pressure discharge lamps or simply discharge lamps. The light output and colour rendition of high-pressure lamps vary considerably depending on the lamp family.

Discharge lamps can only be operated with ballasts. Igniters are additionally required for sodium lamps and metal halide lamps. Furthermore, to compensate blind current when using magnetic ballasts, compensation capacitors must be fitted. The lampholders enable the lamp to be fixed in the luminaire and ensure simple exchange of lamps at the end of their service life.

As well as stabilising the lamp's operating point, ballasts also influence the lamp's output and luminous flux, the system's light output, the service life of the lamps as well as the colour temperature of the light.

The following chapters provide technical information regarding VS components for

- High-pressure sodium lamps (HS lamps)
- Metal halide lamps (HI lamps)
- Metal halide lamps with a ceramic discharge tube (C-HI lamps)
- Mercury vapour lamps (HM lamps)
- Low-pressure sodium lamps (LS lamps)

Electromagnetic or electronic ballasts can be used for high-pressure discharge lamps. Unlike with fluorescent lamps, lamp efficiency is not decisively altered by the use of electronic ballasts. In contrast, electronic ballasts lead to a reduction of the inherent losses and thus to an increase in system efficiency. In addition, electronic ballasts ensure gentle lamp operation, which increases the lamp's service life.

Independent electronic and electromagnetic ballasts have also been developed, which in the form of control gear units then provide special advantages during application.

Electronic Ballasts for HI and C-HI Lamps

Electronic ballasts are fitted with all the components required to operate discharge lamps.

Furthermore, they safely shut down lamps at the end of their service life to prevent high temperatures from being generated within the luminaires that could influence the service life of the luminaires and components.

By adding a strain-relief module, VS electronic built-in ballasts turn into independent operating devices that can, for instance, be used as a power unit and can also be installed in intermediate ceilings in this form.

Assembly Instructions for Electronic Ballasts

Assembly instructions for mounting and installing electronic ballasts for high-pressure discharge lamps

Mandatory regulations

DIN VDE 0100	Erection of low voltage installations
EN 60598-1	Luminaires – part 1: general requirements and tests
EN 61347-1	Operating devices for lamps – part 1: general and safety requirements
EN 61347-2-12	Control gear for lamps; part 2-12: Particular requirements for d.c. or a.c. supplied electronic ballasts for discharge lamps (excluding fluorescent lamps)
EN 55015	Limits and methods of measurement of radio disturbance characteristics of electrical lighting and similar equipment
EN 61000-3-2	Electromagnetic Compatibility (EMC) – part 3: maximum values – main section part 2: maximum values for mains harmonics (device input current up to and including 16 A per conductor)
EN 61547	Installations for general lighting purposes – EMC immunity requirements

Descriptions of VS EBs for discharge lamps

The type designations for VS HID ballasts all follow the same pattern, as follows:

EHXc	70	.326
Electronic ballast for HID lamps	Wattage	Serial number

Mechanical mounting

Surface	Firm, flat surface required to ensure good heat transfer. Avoid mounting on protruding surfaces.
Mounting location	Electronic ballasts must be protected against moisture and heat. Installation in outdoor luminaires: water protection rate of > 4 (e.g. IP54 required).
Fastening	Using M4 screws in the designated holes
Heat transfer	If the ballast is destined for installation in a luminaire, sufficient heat transfer must be ensured between the electronic ballast and the luminaire casing. Electronic ballasts should be mounted with the greatest possible clearance to heat sources or lamps. During operation, the temperature measure at the ballast's t_c point must not exceed the specified maximum value.

Supplement for independent electronic ballasts

Mounting position	Any position using the mounting tabs
Clearance	Min. of 0.10 m from walls, ceilings and insulation Min. of 0.10 m from further electronic ballasts Min. of 0.25 m from sources of heat (lamp)
Surface	Solid; EB must not be allowed to sink into insulation materials

1

2

3

4

5

6

7

8

9

10

Technical specifications

Type	Operating voltage range AC: 220 V...240 V	Protective conductor mA	Mean service life*** hrs.	Power factor λ	Temperature protection*	Possible no. of VS devices/automatic cut-out type			
						B (10A)	B (16A)	C (10A)	C (16A)
Standard EB									
EHXc 35.325 (183033;183034)	±10%	≤ 0.5	32,000 (t _c 85 °C)	0.95	yes**	7	12	12	20
			40,000 (t _c 80 °C)						
			50,000 (t _c 75 °C)						
EHXc 35.325 (183035)	±10%	≤ 0.5	32,000 (t _c 80 °C)	0.95	yes	7	12	12	20
			40,000 (t _c 75 °C)						
			50,000 (t _c 70 °C)						
EHXc 35G.327	+6 - 10%	≤ 0.5	30,000 (t _c 80 °C)	> 0.95	yes	7	12	12	20
EHXc 50.358	±10%	≤ 0.5	40,000 (t _c 80 °C)	0.95	yes**	7	12	12	20
EHXc 70.326 (183036; 183037)	±10%	≤ 0.5	32,000 (t _c 80 °C)	0.95	yes**	7	12	12	20
			40,000 (t _c 75 °C)						
			50,000 (t _c 70 °C)						
EHXc 70.326 (183038)	±10%	≤ 0.5	26,000 (t _c 75 °C)	0.95	yes	7	12	12	20
			40,000 (t _c 65 °C)						
			50,000 (t _c 60 °C)						
EHXc 70.373	±10%	≤ 0.5	30,000 (t _c 80 °C)	0.95	yes	20	32	20	32
			50,000 (t _c 70 °C)						
EHXe 70.357	±10%	≤ 0.5	30,000 (t _c 75 °C)	0.95	yes	7	12	12	20
EHXc 270.317	+6 - 10%	≤ 0.5	50,000 (t _c 70 °C)	0.98	yes	4	7	7	12
EHXc 100.353	±10%	< 2	50,000 (t _c 70 °C)	> 0.95	yes	4	6	6	11
EHXc 150G.334	+6 - 10%	≤ 0.5	50,000 (t _c 75 °C)	> 0.98	yes	4	7	7	12

* The devices are fitted with a temperature switch to protect against impermissible overheating.

Once the device has cooled down, it is switched on again. It may prove necessary to briefly dis- and then reconnect the device to the mains voltage.

** The temperature protection inside the luminaire must be checked when using devices without a cap.

*** To achieve the mean service life, the max. temperature (t_{c max}) at the t_c point must not be exceeded; failure rate = 0.2% per 1000 hrs

Product features

Shutdown of defective lamps

In the event of a lamp failing to ignite or of a lamp with an increased operating voltage (end of the lamp's service life), the electronic ballast will switch off after a defined period of time (< 20 minutes). The ballast will also shut down if the lamp fails to attain its specified rated output. The ballast can be reset by disconnecting and then reconnecting the mains voltage. The ballast must always be disconnected from the mains prior to changing a lamp.

EOL Effect

In high-pressure discharge lamps, the EOL effect manifests itself in a change of the lamp's voltage. These changes can, for instance, occur due to unsealed parts of the burner or the rectifier effect. An automatic EOL cut-out prevents safety risks at the end of the service life of high-pressure discharge lamps. EOL tests are conducted to check the behaviour of electronic ballasts at the end of a lamp's service life. The EOL cut-out stops the lamp base overheating at the end of a lamp's service life.

Short-circuit resistance

The ballast outputs (to the lamp) are short-circuit-proof. Short-circuits between the lamp connection and the casing (earth conductor) will destroy the ballast.

Temperature protection

To prevent excess temperatures, some ballasts are fitted with temperature protection. A ballast will restart after it has cooled down. It might be necessary to briefly interrupt the supply voltage. The above table contains a list of temperature-protected devices.

Transient mains peak protection

Values are in compliance with EN 61547 (interference immunity).

Electrical installation

- Wiring**
- The wiring between the mains, electronic ballast and lamp must comply with the respective circuit diagram. Note: the luminaire casing (metal) must be connected to the earth conductor.
 - The electronic ballast must be earthed using a toothed washer or similar (protection class I, compliance with RFI/BCI standards).
 - To ensure compliance with RFI suppression limits, mains conductors should not be wired parallel to lamp conductors and maximum clearance should be ensured.
 - After the installation of electronic ballasts, luminaires must be tested to ensure compliance with maximum values laid down in EN 55015.
- It is permissible to connect the protective conductor of the ballast by attaching the ballast to metal conductors that are connected to the protective conductor. In doing so, care must be taken to ensure the protective conductor is contacted in accordance with EN 60598. If, however, a ballast is fitted with a connection terminal for a protective conductor without through-wiring and if this is to be used to connect the protective conductor, this connection terminal may only be used for the ballast itself.
- Push-in terminals** The used terminals can be connected using rigid or flexible conductors with a section of 0.75-2.5 mm² (K35 ballasts: 0.5-1.5 mm²). The stripped conductor length is 10-11 mm (K35 ballasts: 8.5-9.5 mm, K40/41 and M42/M45 ballasts: 5-6 mm) for terminal grid 3.5 mm. Conductors must not be tin-plated.
- Error current** Impulse-resistant leak-current protection must be installed. Distribute the luminaires to phases L1, L2 and L3; install tri-phase FI switches. If permissible, install FI switches with 30 mA leak current; connect no more than 15 luminaires as FI switches can be triggered at half the leak current value.
- Tri-phase connection of luminaires with EB**
- Prior to operating newly installed lighting systems: check the mains voltage is appropriate to the electronic ballast's mains voltage range (AC, DC).
 - The N-type conductor must be properly connected to all luminaires or ballasts.
 - Conductors can only be connected or disconnected if the ballast is disconnected from the mains. Attention: N-type conductors must never be disconnected individually or as the first element.
 - Insulation resistance test: from L to PE (L and N must not be connected)
 - The neutral conductor must be reconnected after completion of the test.
- Electromagnetic Compatibility (EMC)**
- Vossloh-Schwabe's electronic ballast range was developed in accordance with valid EMC standards (interference, interference immunity and mains harmonics) and specially designed to ensure safe compliance with the limiting values. It is assumed that any remarks regarding conductor wiring and conductor length in the instructions for installing electronic ballasts in luminaires or for independent ballasts will be observed.
- Compensation** Luminaires with electronic ballasts do not need compensation (power factor ≥ 0.95).

Selection of automatic cut-outs

- Dimensioning automatic cut-outs**
- High transient currents occur when an EB is switched on because the capacitors have to load. Lamp ignition occurs almost simultaneously. This also causes a simultaneous high demand for power. These high currents when the system is switched on put a strain on the automatic conductor cut-outs, which must be selected and dimensioned to suit.
- Release reaction** The release reaction of the automatic conductor cut-outs comply with VDE 0641, part 11, for B, C characteristics.

1

2

3

4

5

6

7

8

9

10

No. of electronic ballasts (see table on page 86)

The maximum number of VS ballasts applies to cases where the devices are switched on simultaneously. Specifications apply to single-pole fuses. The number of permissible ballasts must be reduced by 20% for multi-pole fuses. The considered circuit impedance equals 400 mΩ (approx. 20 m [2.5 mm²] of conductor from the power supply to the distributor and a further 15 m to the luminaire). Doubling circuit impedance to 800 mΩ increases the possible number of ballasts by 10%.

Additional information

Information on the installation of electronic ballasts for optimising EMC. To ensure good radio interference suppression and the greatest possible operating safety, the following points should be observed when installing electronic ballasts:

- Conductors between the EB and the lamp (HF conductors) must be kept short (reduction of electromagnetic interference).
- Mains and lamp conductors must be kept separate and if possible should not be laid in parallel to one another. The distance between HF and mains conductors should be as large as possible, ideally > 5 cm. (This prevents the induction of interference between the mains and lamp conductors.)
- The mains conductor within the luminaire must be kept short (to reduce the induction of interference).
- Devices must be properly earthed. EBs require secure contacts to the luminaire casing or must be earthed using a PE connection. This PE connection should be effected using an independent conductor to achieve better dissipation of the leak current. EMC improves at frequencies greater than 30 MHz.
- The mains conductor must not be laid too close to the EB or the lamp (this is especially important in the event of through-wiring).
- Mains and lamp conductors must not be crossed. Should this be impossible to avoid, conductors should be crossed at right angles to one another if at all possible.
- Should conductors be wired through metal parts, such conductors must always be additionally shielded (e.g. with an insulating sleeve or grommet).

Temperature

Reference point temperature t_c

The safe operation of electronic ballasts is dependent on the maximum permissible temperature not being exceeded at the measuring point. Vossloh-Schwabe has determined a casing temperature measuring point – $t_{c \text{ max.}}$ – on all EB casings. To avoid shortening the service life or diminishing operating safety, the stipulated maximum temperature must not be exceeded at this t_c point. This point is determined by testing the converter during normal, IEC-standardised operation at the specified ambient temperature (t_a), which is also indicated on the type plate. As both the design-related ambient temperature and the ballast's inherent heat, as determined by the installed load, are subject to great variation, the casing temperature should be tested at the t_c point under real installation conditions.

Ambient temperature t_a

The ambient temperature – as specified on every EB – denotes the permissible temperature range within the luminaire.

Reliability and service life

If the max. temperature at the t_c reference point (as specified on the type plate and the technical documentation of the ballast) is not exceeded, the defined service life can be expected to be achieved, assuming a switching cycle of 165 minutes on and 15 minutes off. See table on page 86 for service life details.

Circuit diagrams for metal halide lamps (HI) and high-pressure sodium lamps (HS) with electronic ballasts (EB)

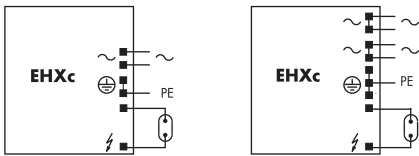

35G.327, 35.325,
50.358, 70.326,
150G.334

100.353

Electromagnetic Ballasts for Discharge Lamps

Electromagnetic ballasts for HI and HS Lamps

As the lamp manufacturer's reference values regarding lamp current and voltage are generally identical for metal halide (HI) and high-pressure sodium lamps (HS) of the same lamp wattage and the impedance values required for the ballast are also identical, the same ballasts can frequently be used for both lamp types. It should be remembered that HI lamps react sensitively to impedance deviations from the rated value with appreciable colour changes. Vossloh-Schwabe ballasts therefore comply with the lamp's narrower tolerances. Moreover, ballasts remain below the maximum peak DC value for HI lamps. This value is not specified for HS lamps; instead, the maximum stated start-up current must not be exceeded.

In order to keep the temperature of the luminaires and the electrical values of the lamps within tolerable limits, the impedance of the ballasts must remain constant over the entire service life. A so-called service life test (test of thermal durability) provides proof of this requirement having been met.

HI and HS lamps constitute a special case in terms of thermal testing. In rare cases, a safety risk can occur at the end of the service life of lamps fitted with external bulbs. The safety risk is caused by the so-called lamp rectifier effect, which can lead to overheating of ballasts, ignitors, lampholders and conductors and can therefore destroy the luminaire. Against this background, the luminaire standard EN 60598-1 "luminaires; part 1: general requirements and tests" has been supplemented by tests concerning this safety risk. As a result, since 1 September 2002, it has been illegal to market luminaires that do not comply with the new regulations. This means luminaires need to be fitted with thermal protection that prevents a luminaire from overheating in the event of this malfunction.

In this respect, it is recommended to use VS ballasts with temperature switches that have already been tested using this circuit.

Electromagnetic ballasts for HM lamps

Even in the event of major mains fluctuations (92-106% of the rated voltage), the ballast must not fall short of the no-load voltage specified by the lamp manufacturer nor exceed a fixed short-circuit current. The start-up current must be high enough to ensure that at least 90% of the lamp's operating voltage is achieved within 15 minutes.

Test circuit for thermally protected ballasts

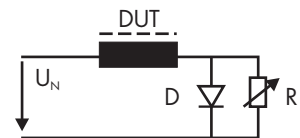

DUT Device under Test
D Diode, 100A, 600V
R Resistor, 0...200
(1/2 lamp output)
 U_N 110% of rated
supply voltage

1

2

3

4

5

6

7

8

9

10

Power reduction with HS and HM lamps

The lamp wattage can be reduced by operating the ballast at a higher impedance value, higher than the rated value. The lamp manufacturer's specifications must be observed in doing so to avoid shortening the lamp's service life. The lamps should be started at the ballast's rated impedance and only switched down to reduced operation after a period of at least five minutes.

The impedance value can be altered by using an additional ballast (high-effort option) or by using a switchable ballast (low-cost option). These ballast models can be switched using either a modern, time-controlled electronic power reduction switch, which is equipped with an additional control conductor (230 V), or a power reduction switch with a constant incentive rate setting (no control conductor).

The construction of power reduction switches with control conductors differs according to the selected increase in impedance.

Power reduction with switchable ballasts

Ballast type	Tested with	Mains voltage	System output 100% W	Reduced system output		Reduced luminous flux % (approx. values)
				W	%	
U-NaHJ 70/40%	HS 70	230, 50	83	50	60	55
U-NaH 100/40%	HS 100	230, 50	114	67	58	55
U-NaH 150/40%	HS 150	230, 50	160	98	61	55
U-NaH 250/40%	HS 250	230, 50	271	150	55	50
U-NaH 400/250.805	HS 400	230, 50	421	253	60	50
Q 80/50.596	HM 80	230, 50	90	55	61	55
Q 125/80.611	HM 125	230, 50	134	89	65	55
U-Q 250/150.438	HM 250	230, 50	274	164	60	55
U-Q 400/250.437	HM 400	230, 50	422	267	65	55

Example: Osram lamp, type NAV, HQL

Start-up switches

As high-pressure lamps operate with a start-up phase, the lamp's full luminous flux will only be reached after completion of this start-up period. In the event of disconnection from the mains, this start-up phase is dependent on the lamp's temperature. If an additional source of light is desired or required for this start-up period for safety-relevant applications, it is possible to switch on an auxiliary lamp with the help of a start-up switch.

There are two types of start-up switches:

- AS 1000 K for superimposed ignition systems. This switch monitors the lamp's operating voltage. If this is below a defined value (approx. 60% of the lamp's luminous flux), an auxiliary lamp is switched on.
- AS 1000 K A10 for pulse ignition systems and electronic ballasts.
This model switches the auxiliary lamp off after a defined period of time (10 minutes), after which the high-pressure lamp will have reached the desired illumination level.

Lamp family	Typical start-up time	Typical restart time (mains interruption at lamp operating temperature)
HS	3 min.	5 min.
HI / C-HI	3 min.	10 min.
HM	4-5 min.	4-5 min.
LS	10 min.	5 min.

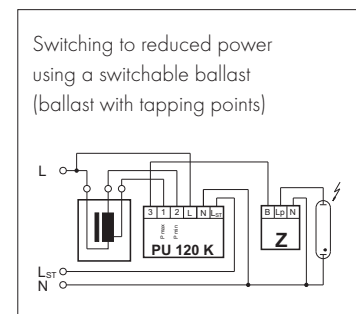
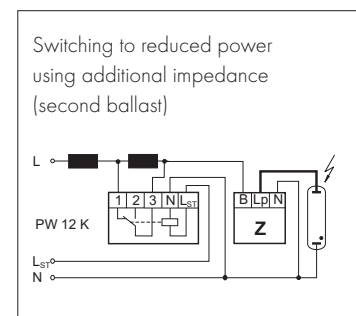

Control Gear Units for High-pressure Discharge Lamps

With electromagnetic ballasts

Control gear units with electromagnetic ballasts for high-pressure sodium lamps (HS), metal halide lamps (Hl) and metal halide lamps with a ceramic discharge tube (C-Hl) are fitted with all the components needed to ensure safe normal operation. Apart from a ballast, control gear units also contain a digital timer ignitor with IPP++ technology (Intelligent-Pulse-Pause-Mode), a compensation capacitor and a temperature switch with automatic reset. As all these components form a matched system, they create optimum operating conditions for lamps and small models. These compact control gear units remove the need for separate installation and wiring of individual components, thus considerably reducing assembly time.

Mandatory regulations

DIN VDE 0100	Erection of low voltage installations
EN 60598-1	Luminaires – part 1: general requirements and tests
EN 61347-1	Operating devices for lamps – part 1: general and safety requirements
EN 61347-2-1	Control gear for lamps; part 2-1: special requirements for ignitors (other than glow starters)
EN 61347-2-9	Control gear for lamps; part 2-9: special requirements for ballasts for discharge lamps (except fluorescent lamps)
EN 60923	Ballasts for discharge lamps – performance requirements
EN 60927	Operating devices for lamps; ignitors (glow starters); performance requirements
EN 61048	Operating devices for lamps – capacitors for fluorescent lamp circuits and other discharge lamp circuits; general and safety requirements
EN 61049	Operating devices for lamps – capacitors for fluorescent lamp circuits and other discharge lamp circuits; performance requirements
EN 55015	Limits and methods of measurement of radio disturbance characteristics of electrical lighting and similar equipment
EN 61000-3-2	Electromagnetic Compatibility (EMC) – part 3: maximum values – main section part 2: maximum values for mains harmonics (device input current up to and including 16 A per conductor)
EN 61547	Installations for general lighting purposes – EMC immunity requirements

1

2

3

4

5

6

7

8

9

10

Technical specifications

Operating voltage range

Control gear units can be operated at the specified mains voltage within a tolerance range of $\pm 10\%$ for HS/HL lamps and $\pm 3\%$ for C-HI lamps.

Leak current ≤ 0.1 mA

Compensation/power factor

Parallel-compensated control gear units with a power factor of $\lambda < 0.9$ ($\lambda < 0.85$ for 100 W)

Degree of protection

IP40, IP65

IP54 for aluminium casing

Protection class

Independent, protection class II control gear units (plastic casing)

Independent, protection class I control gear units (aluminium casing)

Max. ambient temperature

See t_a value on the type plate of the control gear unit

Lead length to lamp

Max. 10 m

"F" designation

Suitable for mounting on surfaces of normal flammability

Mechanical mounting

Mounting position

Any position using the mounting tabs

Clearance

Min. of 0.20 m from walls, ceilings and insulation

Min. of 0.20 m from further control gear units

Min. of 0.25 m from sources of heat (lamp)

Surface

Solid; control gear unit must not be allowed to sink into insulation materials

Electromagnetic compatibility (EMC)

Interference

Interference voltage measurements only have to be taken at the connection terminals for luminaires with electromagnetic control gear units as these systems operate with lamp voltages of under 100 Hz. These low-frequency interference voltages are generally not critical with high-pressure discharge lamps with electromagnetic control gear units.

Interference immunity

Thanks to the robust design and choice of materials, electromagnetic control gear units provide a high degree of interference immunity and are not impaired by normal mains power interference.

Mains Harmonics

After every zero crossing of the lamp current, discharge lamps experience a re-ignition peak as the lamps go out for a brief (imperceptible) moment. These re-ignition peaks of discharge lamps generate mains harmonics that are smoothed by the ballast's impedance. VS electromagnetic control gear units all comply with the stipulated maximum values.

Selection of automatic cut-outs for VS control gear units

Dimensioning automatic cut-outs

When a control gear unit is switched on, high transient current peaks occur due to the smoothing capacitor having to load. The lamps are ignited almost simultaneously, which also causes energy consumption peaks. These high system switch-on currents put a strain on the automatic conductor cut-outs, which must be selected and dimensioned to suit.

Release reaction The release reaction of the automatic conductor cut-outs comply with VDE 0641, part 11, for B and C characteristics.

No. of control gear units

The following values are meant as guidelines only and may vary depending on the respective lighting system. The specified maximum number applies to the number of devices that can be switched on simultaneously. Specifications apply to single-pole fuses; using multi-pole fuses reduces the maximum number by 20%. The considered circuit impedance equals 400 mΩ (approx. 20 m [2.5 mm²] of conductor from the power supply to the distributor and a further 15 m to the luminaire). Doubling circuit impedance to 800 mΩ increases the possible number of control gear units by 10%.

Type of control gear unit	Type of automatic cut-out			
	B (10 A)	B (16 A)	C (10 A)	C (16 A)
VNaHJ 35PZT	7	12	12	20
VNaHJ 70PZT	7	12	12	20
VNaHJ 100PZT	6	10	10	16
VNaHJ 150PZT	5	8	8	14
VNaHJ 250PZT	3	5	5	7
VNaHJ 400PZT	2	4	3	5

Safety functions

Shutdown of defective lamps

In the event of a lamp failing to ignite the control gear unit will automatically shut down after a preset safety period. The programmed switch off time prevents flickering at the end of the lamp's service life. The control gear unit can be reset after shut down and lamp changing by disconnecting and then reconnecting the mains voltage.

Temperature protection

To protect against impermissible excess temperatures, the devices are fitted with a temperature fuse.

Protection against installation and wiring errors

The integrated IPP⁺⁺ function will prevent the power unit from making any attempt to start the lamp in the event of an installation or wiring error and also if the neutral conductor is dislodged within the existing mains voltage network (three-phase supply network). Should the nominal supply voltage be connected, the power unit will begin starting the lamp immediately.

Reliability and service life

The control gear units can be expected to provide a service life of 50,000 operating hours provided that the assembly instructions are observed and the maximum tw value of the ballast is not exceeded. Failure rate:

< 0.1%/1,000 hrs

1

2

3

4

5

6

7

8

9

10

Electrical installation

Connection terminals

Terminals can be contacted with rigid or flexible conductors

- Rigid conductors: max. 2.5 mm²
- Flexible conductors: max. 2.5 mm²
- Stripped lead length: 10–11 mm
- Conductors must not be tin-plated

Connection leads

Admissible diameter 7–9 mm

The suitability of luminaire conductors and cables for use within luminaires with ignition devices must be checked in accordance with luminaire standard EN 60598-1 10.2.2.

In general, all silicone and standard PVC cables meet these requirements.

Wiring

The wiring between the supply mains, control gear unit and lamp must be in accordance with the circuit diagram shown on the type plate.

Note: luminaire casing (metal) must be connected to the protective earth conductor.

Assembly Instructions for Electromagnetic Ballasts

For mounting and installing electromagnetic ballasts for high-pressure discharge lamps

Mandatory regulations

DIN VDE 0100	Erection of low voltage installations
EN 60598-1	Luminaires – part 1: general requirements and tests
EN 61347-1	Operating devices for lamps – part 1: general and safety requirements
EN 61347-2-9	Operating devices for lamps; part 2-9: special requirements for ballasts for discharge lamps (except fluorescent lamps)
EN 60923	Ballasts for discharge lamps – performance requirements
EN 55015	Maximum values and methods of measurement for RFI suppression in electrical lighting installations and similar electrical appliances
EN 61000-3-2	Electromagnetic Compatibility (EMC) – part 3: maximum values – main section part 2: maximum values for mains harmonics (device input current up to and including 16 A per conductor)
EN 61547	Installations for general lighting purposes – EMC immunity requirements

Technical specifications

Operating voltage range

The ballasts can be operated at the specified mains voltage within a tolerance range of $\pm 10\%$ for HS/HI and HM lamps and $\pm 3\%$ for C-HI lamps.

Leak current ≤ 0.1 mA

Compensation/power factor

Inductive ballasts: $\lambda \leq 0.5$

Parallel-compensated ballasts: $\lambda \geq 0.85$

Mechanical mounting

Mounting position

Any

Mounting location

Ballasts are designed for installation in luminaires or comparable devices. Independent ballasts do not need to be installed in a casing.

Fastening

Preferably using M4 to M6 screws, depending on the size of the ballast. Encapsulated ballasts may only be used with flat-headed screws (M5), underlaid with a washer (DIN 9021). (Tightening torque ≈ 2 Nm)

Temperature

The winding temperature t_w must be checked during operation and must not exceed the specified maximum value. It must be tested by using the standardised method of measuring resistance. The Δt marking on the type plate is a measure of the ballast's inherent heating and thus of its power loss. The lower this value is the lower the power loss of the ballast. This value is determined using standardised measuring regulations and constitutes a benchmark for comparing ballasts of the same design for selection purposes.

Electromagnetic compatibility (EMC)

Interference

Interference voltage measurements have to be taken at the connection terminals for luminaires with electromagnetic ballasts as these are systems that operate with lamp voltages of under 100 Hz. These low-frequency interference voltages are generally not critical with high-pressure discharge lamps with electromagnetic ballasts.

Interference immunity

Thanks to the robust design and choice of materials, electromagnetic ballasts provide a high degree of interference immunity and are not impaired by normal mains power interference.

Mains Harmonics

After every zero crossing of the lamp current, discharge lamps experience a re-ignition peak as the lamps go out for a brief (imperceptible) moment. These re-ignition peaks of discharge lamps generate mains harmonics that are smoothed by the ballast's impedance. VS electromagnetic ballasts all comply with the stipulated maximum values.

Selection of automatic cut-outs for VS electromagnetic ballasts

Dimensioning automatic cut-outs

When a ballast is switched on, high transient current peaks occur due to parasitic capacitances that can accumulate with the number of luminaires. These high system switch-on currents put a strain on the automatic conductor cut-outs. For this reason, only surge-current-proof automatic cut-outs should be used for lighting systems.

1

2

3

4

5

6

7

8

9

10

Technical Details – Components for Discharge Lamps

Release reaction The release reaction of the automatic conductor cut-outs comply with VDE 0641, part 11, for B and C characteristics.

No. of ballasts The following values are meant as guidelines only and may vary depending on the respective lighting system. The maximum number of VS ballasts applies to cases where the devices are switched on simultaneously. Specifications apply to singlepole fuses. The number of permissible ballasts must be reduced by 20% for multi-pole fuses. The considered circuit impedance equals 400 mΩ (approx. 20 m of [2.5 m²] conductor from the power supply to the distributor and a further 15 m to the luminaire). Doubling circuit impedance to 800 mΩ increases the possible number of ballasts by 10%. The values quoted in the following tables are guidelines and can be affected by system-specific factors.

Possible number of ballasts connected to automatic cut-outs with or without compensation

Lamp data		C _p μF	Max. number of ballasts connected to automatic cut-outs - without compensation / with compensation																			
W	V		C10		C13		C16		C20		C25		B10		B13		B16		B20		B25	
			without	with	without	with	without	with	without	with	without	with	without	with	without	with	without	with	without	with	without	with
Mercury vapour lamps (HM)																						
50	230	7	10	19	13	25	15	31	18	39	23	49	8	10	11	12	13	15	16	18	20	23
80	230	8	6	12	7	15	9	19	11	24	14	30	6	6	8	7	10	9	12	11	15	14
125	230	10	4	7	5	9	7	12	7	15	9	19	4	4	5	5	7	6	9	7	10	9
250	230	18	2	4	3	5	3	6	3	7	4	9	2	2	3	2	3	3	4	3	5	4
400	230	25	1	2	1	3	2	4	2	5	2	6	1	1	1	1	2	22	3	2	3	2
700	230	40	–	1	–	1	1	2	1	2	1	3	1	–	1	–	1	1	1	1	2	1
1000	230	60	–	1	–	1	–	1	1	2	1	2	–	–	–	–	1	–	1	1	1	1
Metal halide lamps (HI)																						
35	230	6	11	22	14	29	18	36	23	45	29	50	9	11	12	14	15	18	18	23	23	27
70	230	12	7	12	9	15	11	18	14	23	17	29	5	8	6	10	8	13	9	16	12	20
100	230	12	6	10	7	13	9	16	11	20	14	25	4	7	5	9	6	11	8	14	10	17
150	230	20	4	7	5	9	6	11	7	14	9	17	2	5	3	6	4	8	5	10	6	12
250	230	32	2	5	2	6	3	7	4	9	5	11	1	3	1	4	2	5	3	6	4	8
400	230	35	2	3	2	4	3	5	4	7	5	8	1	2	1	3	2	4	2	5	3	6
1000	230	85	–	1	–	1	1	1	1	3	1	3	–	–	–	–	–	1	1	1	1	2
2000	380	60	–	1	–	1	–	2	–	2	–	3	–	–	–	–	–	1	–	1	–	2
2000	380	37	–	–	–	–	–	1	–	1	–	2	–	–	–	–	–	–	–	1	–	1
3500	380	100	–	–	–	–	–	–	–	–	–	–	–	–	–	–	–	–	–	–	–	–
High pressure sodium vapour lamps (HS)																						
35	230	6	11	22	14	29	18	36	23	45	29	50	9	11	12	14	15	18	18	23	23	27
50	230	10	9	16	11	20	14	24	18	31	22	38	6	11	8	14	10	17	13	22	16	27
70	230	12	7	12	9	15	11	18	14	23	17	29	5	8	6	10	8	13	10	16	12	20
100	230	12	6	10	7	13	9	16	11	20	14	25	4	7	5	9	6	11	8	14	10	17
150	230	20	4	7	5	9	6	11	7	14	9	17	2	5	3	6	4	8	5	10	7	12
250	230	36	2	5	2	6	3	7	4	9	5	11	1	3	1	4	2	5	3	6	4	8
400	230	45	1	3	1	3	2	4	3	5	4	7	1	2	1	2	1	3	2	4	2	5
600	230	60	1	2	1	2	1	2	2	3	2	4	–	1	–	1	1	2	2	2	2	3
1000	230	100	1	1	1	1	1	1	1	2	2	3	–	–	–	–	–	1	1	1	1	2

Safety functions

The VS range includes ballasts with an integrated temperature switch that safely disconnects the lamp from the power supply if the lamp should develop the rectifier effect towards the end of its service life. The cut-out behaviour of the temperature switch is influenced by the luminaire construction. The luminaire manufacturer is responsible for checking the factory settings of the temperature switch in accordance with EN 60598-1 Section 12.5. VS can adjust the temperature switch to the appropriate cut-out temperature to suit requirements.

Reliability and service life

Provided the maximum winding temperature is not exceeded, the ballasts can be expected to yield a service life of 100,000 operating hours.
Failure rate < 0.025 %/1,000 hrs

Electrical installation

Push-in terminals Terminals can be contacted with rigid conductors up to a maximum of 1.5 mm².

Screw terminals

- Terminals can be contacted with rigid or flexible conductors with ferrules on bare end of core
- Conductor cross-sections are determined by the terminals and can vary according to type 0.5-1.5 mm² / 0.75-2.5 mm² / 1.5-2.5 mm²
- Stripped lead length: 8 - 9 mm
- Conductors must not be tin-plated
- Max. tightening torque 0.5 Nm

Wiring The wiring between the power supply, ballast and lamp must be in accordance with the respective circuit diagram (see pages 98-100).

Components High-pressure discharge lamps must only be fitted with components that are rated to withstand the respective ignition voltage.

1

2

3

4

5

6

7

8

9

10

Circuit diagrams for high-pressure sodium lamps (HS) and metal halide lamps (HI)

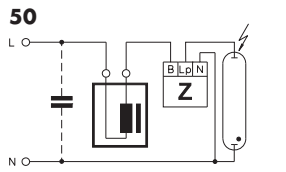

Superimposed ignition of HS and HI lamps

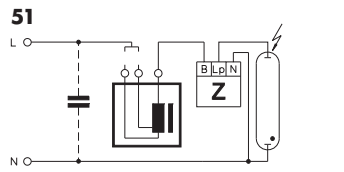

Superimposed ignition of HS and HI lamps (ballasts with two alternative voltage tapping points)

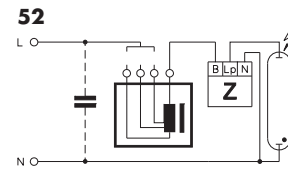

Superimposed ignition of HS and HI lamps (ballasts with three alternative voltage tapping points)

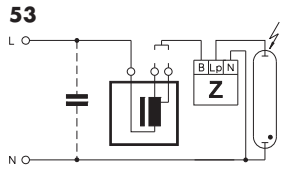

Superimposed ignition of HS and HI lamps (ballasts with two alternative power tapping points)

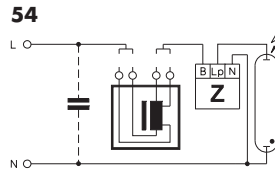

Superimposed ignition of HS and HI lamps (ballasts with two alternative voltage and power tapping points)

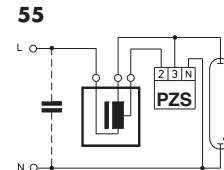

Pulse ignition of standard HS lamps

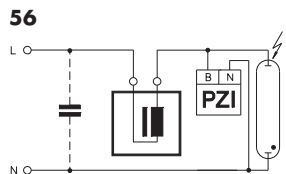

Pulse ignition of HI lamps, ignition voltage 0.9 kV

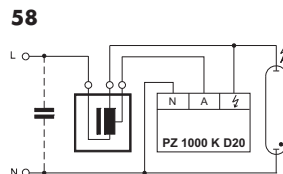

Pulse ignition for HS and HI lamps

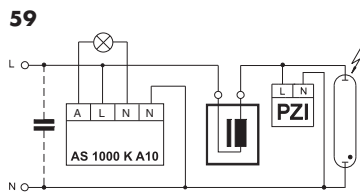

Start-up switch for HI lamps, ignition voltage 0.9 kV

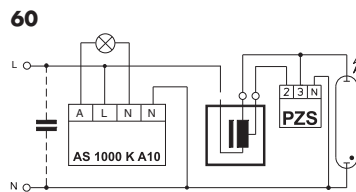

Start-up switch for standard HS lamps

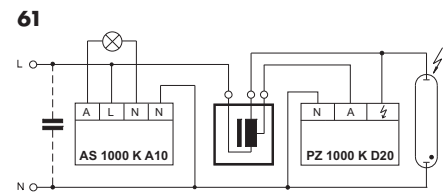

Start-up switch for HS and HI lamp

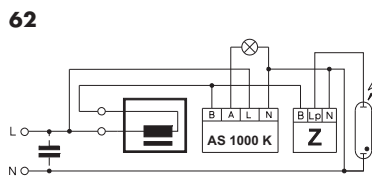

Start-up switch for HS and HI lamps

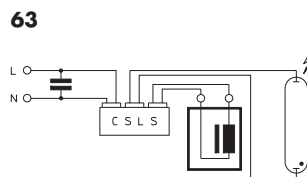

SDW-T lamps

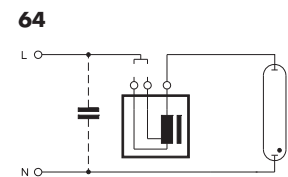

HS lamps with internal ignitor (ballasts with two alternative voltage tapping points)

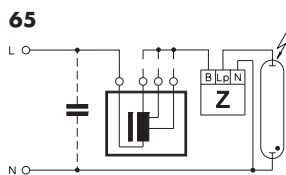

Superimposed ignition of HS and HI lamps with three alternative power tapping points

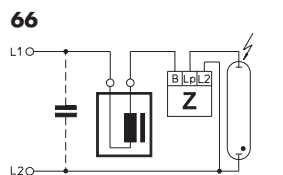

Superimposed ignition of HS and HI lamps with polyphase power systems

Circuit diagrams for mercury vapour lamps (HM)

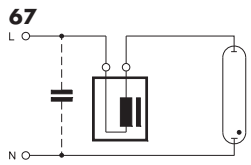

HM lamps

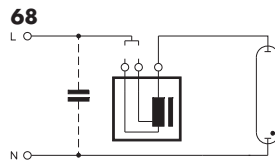

HM lamps (ballasts with two alternative voltage tapping points)

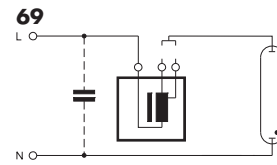

HM lamps (ballasts with two alternative power tapping points)

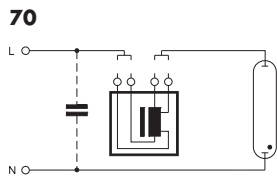

HM lamps (ballasts with two alternative voltage and power tapping points apiece)

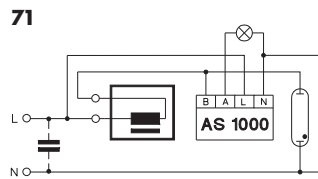

Start-up switch for HM lamps with auxiliary lamp

Power reduction of mercury vapour lamps (HM lamps)

L_{ST} connectable to L1, L2 and L3

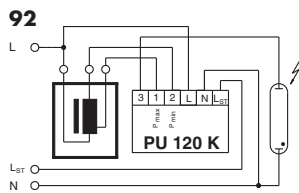

Disconnected control phase ($L_{ST} = 0\text{ V}$) with ballasts with two tapping points

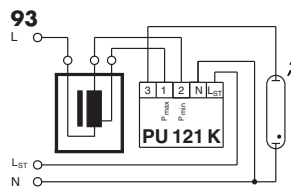

Connected control phase ($L_{ST} = 230\text{ V}$) with ballasts with two tapping points

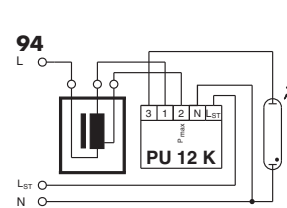

Disconnected control phase ($L_{ST} = 0\text{ V}$) with ballasts with two tapping points

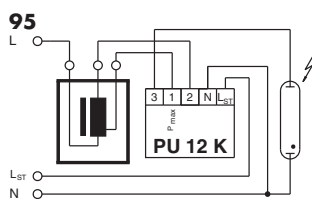

Connected control phase ($L_{ST} = 230\text{ V}$) with ballasts with two tapping points

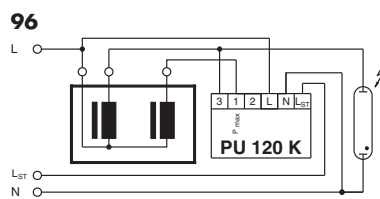

Disconnected control phase ($L_{ST} = 0\text{ V}$) with two ballasts connected in parallel

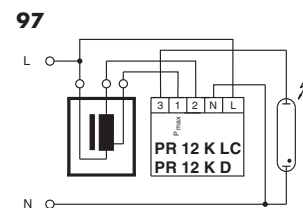

Electronic power reduction without control phase

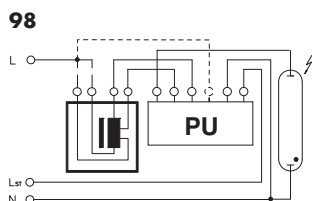

Ballasts with two tapping points and two voltage tapping points ($L_{ST} = 0\text{ V}$ or $L_{ST} > 0\text{ V}$)

1

2

3

4

5

6

7

8

9

10

Power reduction of high-pressure sodium lamps (HS lamps) – superimposed ignition system

L_{ST} connectable to L1, L2 or L3

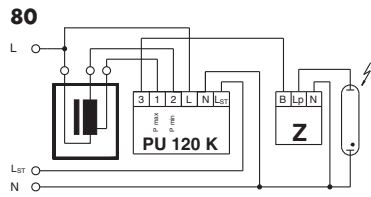

Disconnected control phase ($L_{ST} = 0\text{ V}$) with ballasts with two tapping points

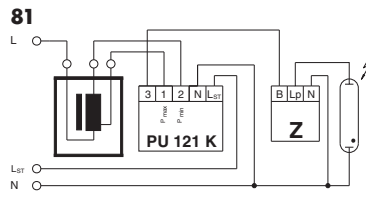

Connected control phase ($L_{ST} = 230\text{ V}$) with ballasts with two tapping points

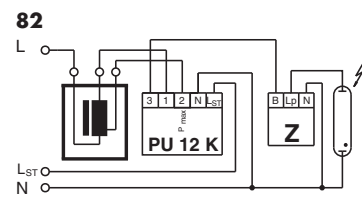

Disconnected control phase ($L_{ST} = 0\text{ V}$) with ballasts with two tapping points

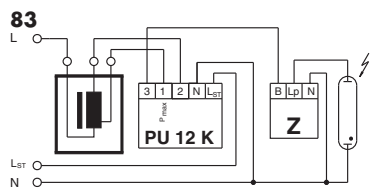

Connected control phase ($L_{ST} = 230\text{ V}$) with ballasts with two tapping points

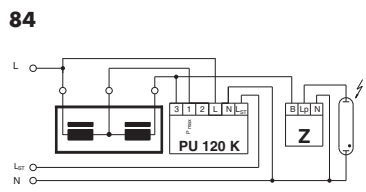

Disconnected control phase ($L_{ST} = 0\text{ V}$) with main ballast and additional inductance

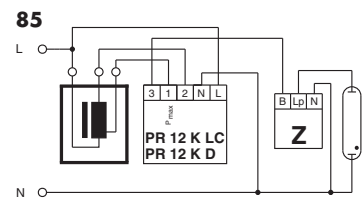

Electronic power reduction without control phase

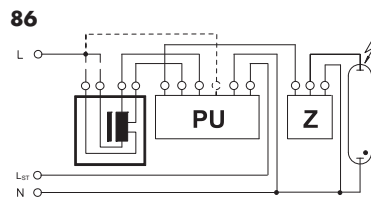

Ballast with two tapping points and two voltage tapping points ($L_{ST} = 0\text{ V}$ or $L_{ST} > 0\text{ V}$)

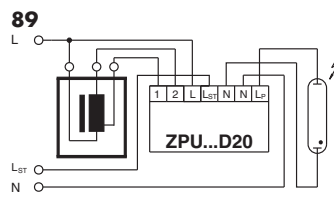

Disconnected control phase ($L_{ST} = 0\text{ V}$) with ballasts with two tapping points

Power switching of LED drivers and electronic ballasts

100

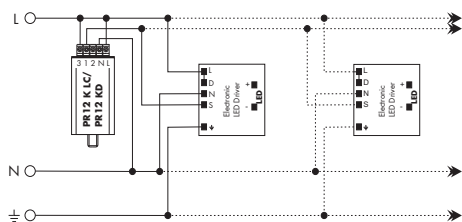

Lampholders for High-pressure Discharge Lamps

Metal halide and high-pressure sodium lamps feature extremely different bases, which include RX7s, Fc2, G8.5, GX8.5, GU8.5, GX10, G12, GX12, PG12, PGJ5, GU6.5, E27 and E40, depending on whether the lamp is single- or double-ended. All lampholders are subject to the same typical conditions found with discharge lamps: high ignition voltages and temperatures. The high start-up currents deserve particular attention in lampholder design. This is also reflected by the insulation materials, which are usually solid ceramics or heat-resistant plastic (e.g. PPS – polyphenylene sulphide). Depending on the lamp's requirements (voltage, current, temperature, etc.), silver, nickel and copper alloys with thick nickel coatings are used as conductors. The luminaire regulation EN 60598-1 (VDE 0711 part 1), defines the safety requirements with regard to ignition voltages in connection with creepage and air clearance distances. Special care must be taken to ensure that lampholders are approved for discharge lamps when using high-pressure lamps with E27 and E40 Edison bases. Lampholders that are suitable for this purpose are marked with a maximum value of "5 kV" and comply with the increased creepage and air clearance distances specified by the lampholder requirements in EN 60238 (VDE 0616 part 1). The lampholder regulations governing special lampholders, EN 60838-1 (VDE 0616 part 5), apply analogously to all other base systems. The high ignition voltage pulses also place special demands on the conductors. In practice, silicone-insulated conductors with an outer diameter of 3.6 mm have proved to be suitable for discharge lamps. Silicone-insulated conductors with a glass-silk lining with a diameter of 7 mm should be used for lamps with an instant hot restart (20 kV) function.

When connecting lampholders to push-in terminals of ballasts, the diameter of the conductor and the length of the stripped cables must be taken into account to ensure correct operation of the installed components. To this end, Vossloh-Schwabe can make additional versions available with compacted cable ends as further options.

When using compacted cable ends, the reduction of the cable diameter at the end of the cable must be taken into account, which means that the respective ballast push-in terminal has to be capable of taking the next-smaller cable diameter (see table with examples).

When using screw terminals to connect a ballast, it is recommended to use a ferrules on the bare end of core.

Cable cross-section mm ²	Push-in terminal range on the ballast when using compacted cable ends mm ²
0.75	≥ 0.5
1	≥ 0.75

Bases for the most commonly used HI and HS lamps

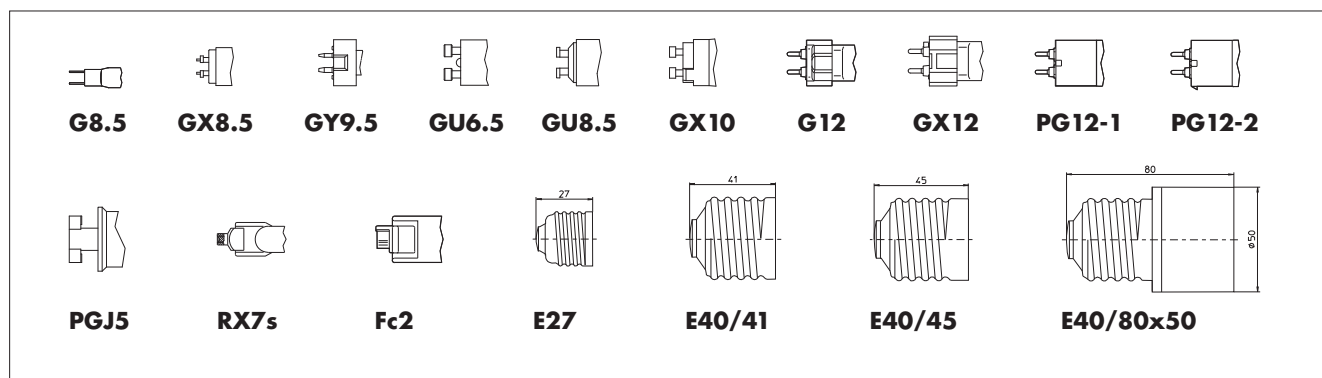

VS lampholders for the UL market and UL approved leads are available for all common lamp types.

Further information can be found at www.unvlt.com.

Ferrule on bare end of core

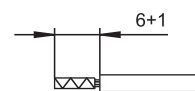

Compacted cable ends

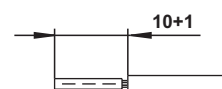

Bases for the most commonly used HM lamps

Edison bases are predominantly used for mercury vapour lamps (HM)

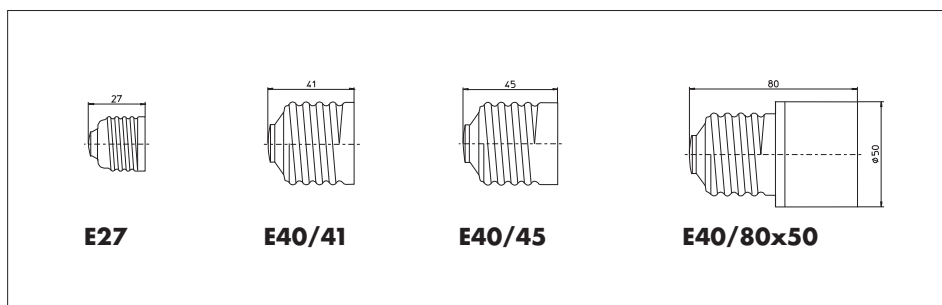

Ignitors

Ignition voltages for high-pressure sodium lamps (HS) and metal halide lamps (HI)

The ignition voltage of HS and HI lamps is determined by the respective lamp technology as well as the creepage and air clearance distances of the base-lampholder system. High-pressure sodium lamps of 35, 50 and 70 W with an E27 base are ignited with a voltage of between 1.8 and 2.3 kV. All other high-pressure lamps of the sodium and metal halide families require an ignition voltage of between 4 and 5 kV (except for special lamps and lamps with base PGJ5).

Superimposed ignitors

Superimposed ignitors work independently of ballasts and generate defined ignition pulses within the voltage ranges of 220–240 V \pm 10% and 380–415 V \pm 10%. As the mains frequency only plays a minor role, these systems work equally well at 50 Hz and 60 Hz. In accordance with the lamp manufacturer's specifications, pulses or clusters of pulses of defined width and height are generated in every half wave. Although lamp current flows through superimposed ignitors, they only cause low losses in relation to the system's power consumption. The maximum ambient temperature can be calculated by subtracting the ignitor's self-heating, which is caused by the inherent losses, from the specified maximum casing temperature (t_c).

Superimposed ignitors should be mounted near the lampholder. The clearance needed between the ignitor and the lamp is determined by the respective maximum load capacitance, which is specified for each ignitor in the technical specifications. The capacitive load of the cable is dependent on its physical properties and wiring layout; this value usually ranges between 70 pF and 100 pF per metre. The casing temperature must not fall below -30 °C and must not exceed the maximum value specified on the device.

Pulse ignitors

Pulse ignitors use the winding of an inductive ballast to generate the pulse voltage needed to ignite high-pressure discharge lamps. For that reason, ballasts must be designed to withstand these high ignition voltages. In this respect, special attention is paid to the insulation as well as the creepage and air clearance distances. As pulse ignition systems generate high-energy pulses, they are also suitable in the event of longer conductor distances between ignitor and lamp. State-of-the-art ignitors feature electronic circuitry. Depending on their design and the technical requirements, the simplest solution is to connect pulse ignitors in parallel with the lamp. Further models make partial use of the winding of a ballast, which will either feature multiple tapping points for voltage selection or special tapping points for pulse operation.

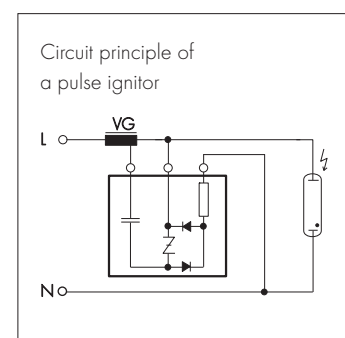
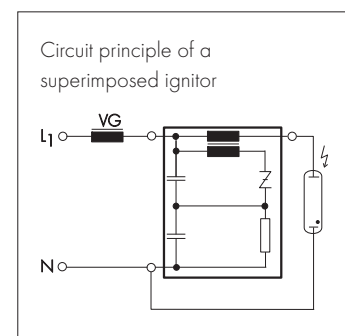

VS ignitors provide the following advantages:

- fully electronic construction
- compact design
- large nominal voltage range
- large output range
- low self-heating
- minimal power loss
- low noise
- long service life
- high electrical safety due to high-quality components (e.g. approved capacitors)
- highly heat-resistant (max. permissible casing temperature t_c : 105°C for superimposed ignitors and 95°C for pulse ignitors)
- highly fire-resistant potting compound (certified according to EN 60926 and UL 94-V0)
- environmentally compatible potting compound (waste key No. 57110)

Product range

Vossloh-Schwabe's product range covers superimposed and pulse ignitors in standard models and with automatic cut-outs. Superimposed ignitors with automatic cut-outs are available with various cut-out times and ignition voltage pulse mechanisms (A and D). In this respect, D-series ignitors featuring the intelligent pulse-pause mode (IPP) are the best solution in terms of ignition reliability and switching off defective lamps.

Electronic ignitors with integrated cut-outs capture data on ignition behaviour during the ignition process. These data, e.g. regarding ignition frequency or failure, serve to identify ageing lamps and to ensure the ignition process is reliably switched off after a defined period of time at the end of the lamp's service life or in the event of defective lamps. This reduces the negative consequences associated with defective lamps.

Superimposed and Pulse Ignitors with Automatic Cut-out

Ignitors with IPP technology and extended cut-out – D series

After connection to mains voltage, D series ignitors generate ignition voltage pulses that are controlled and if necessary switched off by the ignitor in accordance with the lamp's operating state, lamp recognition and the safe burning time. If the safe burning time is not attained after three consecutive ignition attempts, pulse generation will cease.

Appropriately programmed microprocessors enable these performance features of ignitors with IPP technology (Intelligent Pulse-Pause Mode) and extended cut-outs.

Z ... D20/

PZ ... D20 for HS, HI and C-HI lamps
programmed cut-out time: 1,216 seconds

Ignitors with IPP technology and extended cut-outs are available up to an output of 1,000 W.

1

2

3

4

5

6

7

8

9

10

Programmed cut-out function of VS ignitors



Ignitors with automatic cut-out – A series

After connection to mains voltage, A series ignitors supply a continuous stream of ignition voltage pulses until the lamp has ignited or the predefined cut-out time (sum of all ignition periods) has been reached if the lamp fails to ignite.

PZ ... A5 for HSI lamps
 programmed cut-out time: ca. 300 seconds

Pulse ignition systems – overview of technical specifications

For HS, HI and C-HI lamps – PZ 1000 K D20

- for high-pressure sodium lamps (HS) 50–1000 W,
- metal halide lamps (HI) 35–1000 W and
- for ceramic discharge tube lamps (C-HI) 35–400 W
- Ignition voltage: 1.8–2.3 kV or 4–5 kV
- No. of pulses: 2 per mains period
- Load capacitance: 20–1000 pF
- Ignitors with automatic cut-out and IPP technology
- Suitable ballast types: NaHJ ... PZT with special winding tapping point, whose position is determined by the magnitude of the ignition voltage

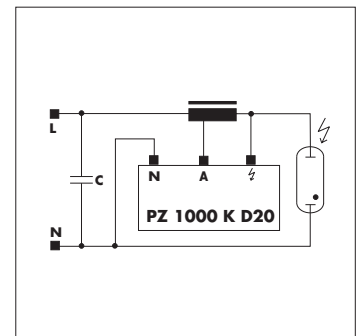

For HS lamps – PZS 1000 K

- for standard high-pressure sodium lamps (HS) 50–1000 W
- Not suitable for discharge lamp models SUPER, PLUS, XL, etc.
- Ignition voltage: approx. 4 kV
- No. of pulses: 1 per second
- Load capacitance: 20–4000 pF
- Suitable ballast types: NaH ... P with winding tapping point (20 V voltage difference)

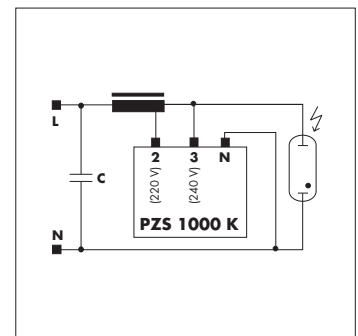

For HI lamps – PZI 1000/1 K

- for metal halide lamps (HI)
- with an ignition voltage up to 0.9 kV
- No. of pulses: 1 per mains period
- Load capacitance: max. 10,000 pF
- Suitable ballast models: Q...

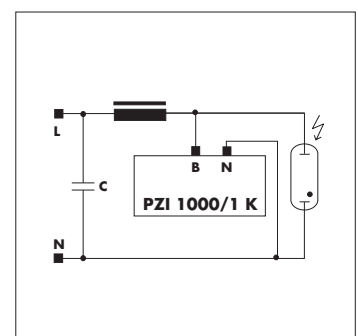

Assembly Instructions for Ignitors

For mounting and installing ignitors

Mandatory regulations

DIN VDE 0100	Erection of low voltage installations
EN 60598-1	Luminaires – part 1: general requirements and tests
EN 61347-1	Operating devices for lamps – part 1: general and safety requirements
EN 61347-2-1	Control gear for lamps; part 2-1: special requirements for ignitors (other than glow starters)
EN 60927	Control gear for lamps; ignitors (other than glow starters); performance requirements
EN 55015	Maximum values and methods of measurement for RFI suppression in electrical lighting installations and similar electrical appliances
EN 61000-3-2	Electromagnetic Compatibility (EMC) – part 3: maximum values – main section part 2: maximum values for mains harmonics (device input current up to and including 16 A per conductor)
EN 61547	Installations for general lighting purposes – EMC immunity requirements

Technical specifications

Operating voltage range

Ignitors can be operated at the specified mains voltage within a tolerance range of $\pm 10\%$.

Max. casing temperature t_c

A maximum casing temperature t_c of 105°C or 95°C is specified for superimposed ignitors and pulse ignitors, respectively. Tests carried out during operation must ensure this maximum value is not exceeded. Selecting an ignitor for higher lamp currents can reduce self-heating and thus also the temperature at the t_c measuring point. Details regarding self-heating can be found in the following table. The temperature structure in the luminaires is negatively influenced by ageing lamps.

Minimum ambient temperature t_a

The minimum ambient temperature t_a for all superimposed and pulse ignitors is -30°C . Ignitors for use in applications with special requirements to the ambient temperature (for example -40°C) are available on request.

1

2

3

4

5

6

7

8

9

10

Superimposed ignitors – Technical specifications

Voltage V/Hz	Ignitor type	Max. lamp current A	Power loss W	Inherent heating K	Ignition voltage kV	Max. load capacity pF	Max. conductor length between ignitor and lamp* m	Connection terminals (mm ²)		Casing material	Dimensions (dia. x L or L x W x H) length without threaded stud mm
								Screw	Push-in		
220-240/ 50-60	Z 70 S	2	< 0.6	< 5	1.8-2.3	200	2	0.75-4	–	Al	Ø35 x 76
	Z 70 K	2	< 0.6	< 5	1.8-2.3	200	2	0.75-4	–	PC	78 x 34 x 27
								–	0.5-2.5		
	Z 70 K D20	2	< 0.6	< 5	1.8-2.3	100	2	0.75-4	–	PC	80 x 34 x 30
								–	0.5-2.5		
	Z 250 S	3.5	< 1.8	< 20	4.0-5.0	100	1	0.75-4	–	Al	Ø35 x 76
	Z 250 K	3.5	< 1.8	< 20	4.0-5.0	100	1	0.75-4	–	PC	78 x 34 x 27
								–	0.5-2.5		
	Z 250 K D20	3.5	< 1.8	< 20	4.0-5.0	100	1	0.75-4	–	PC	80 x 34 x 30
								–	0.5-2.5		
	Z 400 S	5	< 3.0	< 25	4.0-5.0	100	1	0.75-4	–	Al	Ø45 x 76
	Z 400 M	5	< 3.0	< 35	4.0-5.0	50	0.5	0.75-4	–	Al	Ø35 x 76
	Z 400 M VS-Power										
	Z 400 M S										
	Z 400 M K	5	< 3.0	< 35	4.0-5.0	50	0,5	0.75-4	–	PC	78 x 34 x 27
								–	0.5-2.5		
	Z 400 M K VS-Power	5	< 3.0	< 35	4.0-5.0	50	0,5	0.75-4	–	PC	78 x 34 x 27
								–	0.5-2.5		
	Z 400 S D20	5	< 3.0	< 25	4.0-5.0	100	1	0.75-4	–	Al	Ø45 x 90
	Z 400 M K D20	5	< 3.0	< 35	4.0-5.0	50	0.5	0.75-4	–	PC	80 x 34 x 30
							–	0.5-2.5			83 x 34 x 30
Z 750 S	8	< 3.0	< 20	4.0-5.0	100	1	0.75-2.5	–	Al	Ø50 x 90	
Z 1000 S	12	< 6.0	< 35	4.0-5.0	100	1	0.75-2.5	–	Al	Ø50 x 80	
Z 1000 TOP											83 x 83 x 68
Z 1000 S D20	12	< 6.0	< 35	4.0-5.0	100	1	0.75-2.5	–	Al	Ø50 x 89	
Z 1000 L	12	< 6.0	< 35	4.0-5.0	2000	20	0.75-2.5	–	Al	Ø50 x 97	
Z 1200/2,5	15	< 7.5	< 40	2.0-2.5	200	2	0.75-2.5	–	Al	Ø50 x 80	
Z 1200/9	15	< 10.0	< 40	7.0-8.0	50	0.5	0.75-2.5	–	Al	Ø50 x 135	
Z 2000 S	20	< 6.0	< 30	4.0-5.0	100	1	0.75-2.5	–	Al	Ø65 x 96	
380-420/ 50-60	Z 1000 S/400V	6	< 3.3	< 28	4.0-5.0	2000	20	0.75-2.5	–	Al	Ø45 x 84
	Z 2000 S/400V	12	< 5.0	< 32	4.0-5.0	2000	20	0.75-2.5	–	Al	Ø50 x 88
	Z 3500 S/400V	20	< 7.0	< 35	4.0-5.0	100	1	0.75-2.5	–	Al	Ø65 x 96

* With a conductor of, for instance, 100 pF per m (3x2.5 mm²)

Pulse ignitors – Technical specifications

Nominal voltage/ frequency	Pulse ignitor type	Casing temperature t _c	Ignition voltage	Max. load capacity	Max. conductor length between ignitor and lamp*	Connection screw terminals	Casing material	Dimensions (dia. x L or L x W x H) length without threaded stud mm
V/Hz		°C	kV	pF	m	mm ²		
220-240/50-60	PZS 1000 K	95	approx. 4	4000	40	0.5-1.5	PC	50 x 28 x 27
220-240/50-60	PZ 1000 K D20	95	1.8-2.3/ 4.0-5.0	1000	10	0.75-2.5	PC	74 x 34 x 27
220-240/50-60	PZI 1000/1 K	95	0.7-0.9	10000	100	0.5-2.5	PC	57 x 28 x 27
380-420/50-60	PZ 1000/400 V A5	95	4.0-5.0	800	8	0.75-2.5	Al	Ø40 x 80

* With a conductor of, for instance, 100 pF per m (3x2.5 mm²) – wiring must be taken into consideration

Mechanical mounting

Mounting position Any

Mounting location

Ignitors are designed for installation in luminaires or comparable constructions. Ignitors must be protected against radiation of direct lamp heat by appropriate installation.

Clearance from lamp

The clearance needed between ignitor and lamp is determined by the load capacitance of the conductors and by the type of ignitor pulses. The table on page 106 gives details of the clearance needed for a typical 3-phase lead with a cross-section of 2.5 mm² per conductor.

Casing materials Unmarked in the type description: aluminium; marked "K": polycarbonate

Fastening Via threaded stud M8x10 (Z 2000 S, Z 3500 S/400 V: M12x12)

Dimensions The table on page 106 provides details of ignitor dimensions.

Electromagnetic compatibility (EMC)

Interference Ignitors only generate interference due to the high ignition voltages during lamp ignition. This is classified as click interference and is not evaluated in lighting technology. However, as this interference occurs continuously in the event of old lamps that fail to ignite, operators of lighting systems are legally obliged to exchange such lamps.

Interference immunity

Owing to their design and the materials used, VS ignitors are characterised by high interference immunity and comply with the specified maximum values.

Mains harmonics Are not observed during lamp ignition. VS ignitors meet the requirements.

Reliability and service life

The service life of an ignitor is dependent on strict compliance with the casing temperature t_c during operation. As the ignitors are only subjected to loads during high-voltage lamp ignition, a service life of 10 years can be expected provided the t_c values are not exceeded. Failure rate: < 0.04%/1,000 hrs.

Electrical installation

Connection terminals

Ignitors feature screw or push-in terminals. For screw terminals a maximum torque value of 0.8 Nm must not be exceeded when connecting the conductor. Push-in terminals are for rigid conductors with a cross section of 0.5–2.5 mm² or respective flexible conductors with ferrule bare end of cores. Stripped lead ends of 8–9 mm are required. Tinned lead ends are not permitted. The permissible conductor cross-sections can be seen in the table on page 106.

Wiring

The ignitors must be wired between ballast and lamp in accordance with the circuit diagrams on pages 98–100. The load capacitances of the wiring must also be taken into account. Distances to lamps should be kept as short as possible.

1

2

3

4

5

6

7

8

9

10

Power switches for street lighting

In view of the drive to cut public spending on energy and also in the light of environmental policies to protect resources, reducing the power consumption of high-pressure discharge lamps is becoming increasingly important.

Power reduction is possible on high-pressure sodium vapour and mercury vapour lamps and is realised with the aid of electronic actuators or by switching the inductance in the luminaire itself with the aid of power switches.

Provided that the lamp still emits an acceptable minimum of light output and uniformity, these lamps can be used to reduce the lighting level of outdoor lighting systems during off-peak traffic periods (e.g. in accordance with DIN 5044 for street lighting). In conjunction with the appropriate ballasts, the VS power switches constitute a perfect all-round solution for power switching purposes. This VS system has been approved by leading lamp manufacturers.

Power switch PR 12 K LC – Power reduction without control line

The new VS PR 12 K LC power switch is capable of setting the period of power-reduced operation based on the measured burning time of a lighting system. This eliminates the time-consuming task of continually adjusting the times of power-reduced operation to suit constantly changing day-night cycles; it also removes the need for making adjustments due to daylight-saving times and is thus suitable for use worldwide (regionally independent).

Function

The intelligent PR 12 K LC power switch does not require a control line to reduce lamp output; it uses the tapping of the ballast. Thanks to an integrated microprocessor, the PR 12 K LC power switch can measure the burning time of the luminaire. This value is then compared to data stored on the chip and used to set the time at which the luminaire will switch over to power-reduced operation. The luminaire will be operated at reduced power for a minimum of six hours (reduced by approx. 40% of the lamp's nominal rating at 50% of luminous flux). This period of power reduction can be extended to a maximum of 10 hours.

Setting periods of power-reduced operation

The power switch is delivered in its default setting – i.e. the dial is set to 'Test (Code 0)'. After the luminaire has been installed, the desired power reduction time must be set using the dial on the power switch. The power-reduction period can be set to a minimum of six hours and can be extended by up to two hours in both directions (i.e. earlier or later). This results in a maximum power-reduction period of 10 hours.

The dial enables the following settings:

Dial settings Position	Timings	t ₁ Hours	Basic power reduction period (hrs)	t ₂ Hours	Total power reduction time (hrs)	
0	Test	Factory setting: 5 seconds on full load, followed by power reduction				
1	0/0	0	6	0	6	
2	0/1	0	6	1	7	
3	0/2	0	6	2	8	
4	0.5/0	0.5	6	0	6.5	
5	0.5/1	0.5	6	1	7.5	
6	0.5/2	0.5	6	2	8.5	
7	1/0	1	6	0	7	
8	1/1	1	6	1	8	
9	1/2	1	6	2	9	
A	1.5/0	1.5	6	0	7.5	
B	1.5/1	1.5	6	1	8.5	
C	1.5/2	1.5	6	2	9.5	
D	2/0	2	6	0	8	
E	2/1	2	6	1	9	
F	2/2	2	6	2	10	

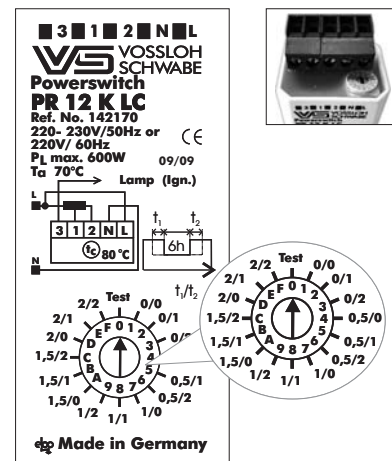

Determining operating/power reduction periods

- The dial is set to the desired period of power reduction, e.g. to position 1 (0/0), which corresponds to a power-reduction period of six hours.
- In the first night, the luminaire is activated by the twilight switch (e.g. at 20:30 hours) and will operate at its nominal rating. After four hours (default setting), the luminaire will be switched down by 40% of the lamp output by the power switch and will then remain in power-reduced operation until the twilight switch turns the system off (e.g. at 06:30 hours).
- During this time, the power switch will measure the entire burning time of the lamp (10 hours in our example).
- The power switch then compares the measured burning period with values stored on the microprocessor. The integrated comparative values of the power switch form the basis for the starting point of power-reduced operation for the following night. The "new" starting time will then be stored by the power switch until the following night.
- In the second night, the lighting system – controlled by the twilight switch and thus dependent on the day/night cycle of the respective region and the time of year – will be activated (and deactivated) at a slightly different time as compared to the first night (either earlier or later, depending on the season)
- With the dial set to position 1, the power switch will thus activate the six-hour period of power-reduced operation after two hours, as per our example, and will then revert to nominal operation before the twilight switch finally sends the signal to switch the lighting system off.
- During the night, the power switch will again measure the entire burning time, compare this value with the stored values and then reset the starting time for power-reduced operation.
- The period of power-reduced operation can be adjusted by changing the dial setting. This period can be extended in both directions (i.e. earlier or later) as detailed in the table on page 108.
- If the dial is, for instance, set to 9 (1/2) this will produce a total period of power-reduced operation of 9 hours (1+6+2). As a result, power-reduced operation will begin one hour earlier than the value determined the night before would ordinarily prescribe and will then extend the minimum period of power-reduced operation by two hours.
- If, in very rare cases, the total burning period of the lighting system should remain under six hours per night, the power switch will activate power-reduced operation after 15 minutes of nominal operation and stay in power-reduced mode until the lighting system is switched off. Switching diagram for power reduced operation.

Switching diagram for power reduced operation

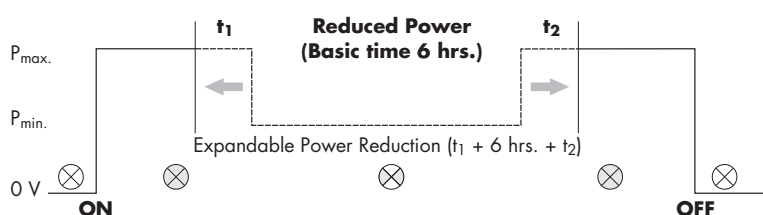

Deactivating reduced-power operation for the night

The functional scope of the PR 12 K LC power switch has been extended with an extra function that permits the operator to deactivate reduced-power operation of the lighting system for a single night. The function can be useful for local festivities or events (e.g. town fêtes) during which it would not be appropriate to operate the local street lighting system at reduced power for safety reasons.

The power switch can be easily programmed to operate the lighting system at normal (i.e. 100%) power for the immediately following night cycle. The power switch is programmed by briefly switching the lighting system on for a period of min. 60 and max. 90 seconds during the day of the event and then switching it off again. The intelligent power switch recognises this command and sets the usual reduced-power operation to zero. The power switch can be successively programmed in this manner as many days in a row as necessary. For every night the lighting system is to be operated at normal (100%) power, the lighting system will have to be switched on for a period of min. 60 and max. 90 seconds during the day. The lighting system will be operated at normal (100%) power in the respective night following day-time activation of the extra function.

1

2

3

4

5

6

7

8

9

10

The power switch does not need to be reprogrammed to return to power-reduced operation of the lighting system. The power switch will automatically return to its original (power-reducing) program if the lighting system is not switched on during the day for a period of min. 60 and max. 90 seconds.

Before testing the extra function, it is important to ensure that the power switch has been in operation for at least one night cycle. Only then will the "learning cycle" start that is required to perform the basic function. After that, the extra function can be activated as described above.

Luminaire testing

The 'Test (Code 0)' dial setting on the power switch is used for luminaire testing during production as well as for direct function tests for "subsequent" installation in the lighting system. After the luminaire is switched on, the lamp is first operated at its nominal rating. After only five seconds, the system will be switched over to power-reduced operation, which will produce a visible change even though the lamp will not yet have attained its full output.

Maintenance work on the lighting system

Maintenance work that requires the lighting system to be switched on for a period of less than two hours will not influence the settings of power switch PR 12 K LC.

Should the lighting system need to be switched on for more than two hours during maintenance work, the PR 12 K LC power switch will activate power-reduced operation after 15 minutes of nominal operation in the following night and will then start to re-measure the total burning time of the lighting system. To determine the starting time of power-reduced operation for subsequent nights, the power switch will again use the stored comparative values.

Switch Units

For power reduction using electronic ballasts with a 1–10 V interface

Suitable for a broad range of lamps

Vossloh-Schwabe's switch units are designed to enable one-step power reduction of lamps (FL, CFL, LED, HS, HI and C-HI) with the help of the respective electronic ballast or converter. To this end, the switch units utilise the 1–10 V interface of the control gear unit. The switch unit is mainly intended for outdoor luminaires in systems with or without a control phase.

Discharge lamps may only be operated at reduced power if they have been expressly approved for this purpose by the manufacturer. In addition, the unit can also be used to dim tubular and compact fluorescent lamps as well as LEDs.

The 1–10 V interface is addressed via an external circuit at the output of the switch unit using a suitably dimensioned resistor. The type of resistor and circuitry are selected by the luminaire manufacturer to suit the desired degree of power reduction.

The switch unit satisfies the provisions of DIN EN 61347 and is suitable for use in outdoor luminaires of protection classes I and II.

Function PR 1-10 V K LC

The intelligent PR 1-10 V K LC switch unit does not require a control line to reduce lamp output.

Thanks to an integrated microprocessor, the PR 1-10 V K LC switch unit can measure the burning time of the luminaire. This value is then compared to data stored on the chip and used to set the time at which the luminaire will switch over to power-reduced operation.

The luminaire will be operated at reduced power for a minimum of six hours (reduced by approx. 40% of the lamp's nominal rating at 50% of luminous flux). This period of power reduction can be extended to a maximum of 10 hours.

Setting periods of power-reduced operation for PR 1-10 V K LC

The PR 1-10 V K LC switch unit is delivered in its default setting – i.e. the dial is set to 'Test (Code 0)'. After the luminaire has been installed, the desired power reduction time must be set using the dial on the switch unit. The power-reduction period can be set to a minimum of six hours and can be extended by up to two hours in both directions (i.e. earlier or later). This results in a maximum power-reduction period of 10 hours.

The dial enables the following settings:

Dial Settings	t ₁	Basic power	t ₂	Total power
Position	Timings	reduction period (hrs)	Hours	reduction time (hrs)
0	Test	Factory setting: 5 seconds on full load, followed by power reduction		
1	0/0	6	0	6
2	0/1	6	1	7
3	0/2	6	2	8
4	0.5/0	6	0	6.5
5	0.5/1	6	1	7.5
6	0.5/2	6	2	8.5
7	1/0	6	0	7
8	1/1	6	1	8
9	1/2	6	2	9
A	1.5/0	6	0	7.5
B	1.5/1	6	1	8.5
C	1.5/2	6	2	9.5
D	2/0	6	0	8
E	2/1	6	1	9
F	2/2	6	2	10

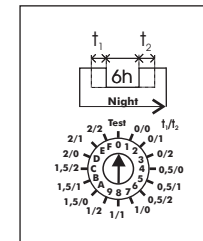
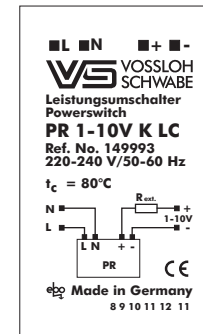

Circuit diagrams for switch units

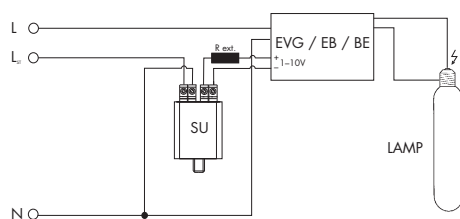

SU 1-10 V K

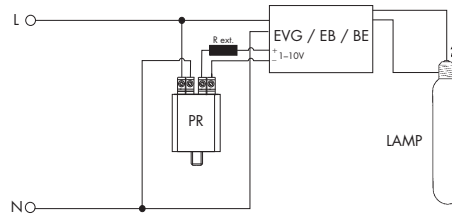

PR 1-10 V K LC

Lamp Table for Discharge Lamps

High-pressure sodium lamps (HS lamps)

Manufacturer	Designation	Base	Lamp current	Superimposed ignition system		Pulse ignition system		Instant restrike ignition system		Control gear unit	EB
				Ignitor	Ballast	Ignitor	Ballast	Ignitor	Ballast		
Lamp output 35 W											
Philips	SDW-T	PG12-1	0.48	ignitor/ stabiliser	NaH 35II	–	–	–	–	–	–
Sylvania	SHP-S...CO/E	E27	0.53	Z 70...	NaHJ 35	PZ 1000KD20	NaHJ 35PZT	–	–	–	–
Lamp output 50 W											
Aura	ST 50 W	E27	0.80	Z 70...	NaH 50	PZ 1000KD20	NaH 50PZT	–	–	VNaH 50	–
Aura	SE 50 W	E27	0.80	Z 70...	NaH 50	PZ 1000KD20	NaH 50PZT	–	–	VNaH 50	–
GE	IU...	E27	0.76	Z 70...	NaH 50	PZ 1000KD20	–	–	–	–	–
GE	IU...XO	E27	0.76	Z 70...	NaH 50	PZ 1000KD20	–	–	–	–	–
GE	IU...SBY	E27	0.76	Z 70...	NaH 50	PZ 1000KD20	–	–	–	–	–
Iwasaki	NH.../HV/...	E27	0.76	Z 70...	NaH 50	PZ 1000KD20	–	–	–	–	–
Narva	NA	E27	0.76	Z 70...	NaH 50	PZ 1000KD20	–	–	–	–	–
Narva	NA...D	E27	0.76	Z 70...	NaH 50	PZ 1000KD20	–	–	–	–	–
Osram	NAVE.../E	E27	0.76	Z 70...	NaH 50	PZ 1000KD20	–	–	–	–	–
Osram	NAVE...4Y	E27	0.76	Z 70...	NaH 50	PZ 1000KD20	–	–	–	–	–
Osram	NAV-T...Super 4Y	E27	0.76	Z 70...	NaH 50	PZ 1000KD20	–	–	–	–	–
Philips	SDW-T	PG12-1	0.78	ignitor/ stabiliser	NaH 50II	–	–	–	–	–	–
Philips	SON...Hg free	E27	0.76	Z 70...	NaH 50	PZ 1000KD20	–	–	–	–	–
Philips	SON...Pro	E27	0.76	Z 70...	NaH 50	PZ 1000KD20	–	–	–	–	–
Philips	SON-T...Plus	E27	0.76	Z 70...	NaH 50	PZ 1000KD20	–	–	–	–	–
Radium	RNP	E27	0.76	Z 70...	NaH 50	PZ 1000KD20	–	–	–	–	–
Sylvania	SHP-S	E27	0.76	Z 70...	NaH 50	PZ 1000KD20	–	–	–	–	–
Sylvania	SHP-TS	E27	0.76	Z 70...	NaH 50	PZ 1000KD20	–	–	–	–	–
Lamp output 70 W											
Aura	ST 70 W	E27	0.98	Z 70...	NaHJ 70	PZ 1000KD20	NaHJ 70PZT	–	–	VNaHJ 70	–
Aura	SE 70 W	E27	0.98	Z 70...	NaHJ 70	PZ 1000KD20	NaHJ 70PZT	–	–	VNaHJ 70	–
BLV	HST-SE	E27	0.98	Z 70...	NaHJ 70	PZ 1000KD20	NaHJ 70PZT	–	–	VNaHJ 70	–
GE	IU	E27	0.98	Z 70...	NaHJ 70	PZ 1000KD20	NaHJ 70PZT	–	–	VNaHJ 70	–
GE	IU...RFL	E27	0.98	Z 70...	NaHJ 70	PZ 1000KD20	NaHJ 70PZT	–	–	VNaHJ 70	–
GE	IU...SBY	E27	0.98	Z 70...	NaHJ 70	PZ 1000KD20	NaHJ 70PZT	–	–	VNaHJ 70	–
GE	IU...XO	E27	0.98	Z 70...	NaHJ 70	PZ 1000KD20	NaHJ 70PZT	–	–	VNaHJ 70	–
Iwasaki	NH.../HV/...	E27	0.98	Z 70...	NaHJ 70	PZ 1000KD20	NaHJ 70PZT	–	–	VNaHJ 70	–
Narva	NA	E27	0.98	Z 70...	NaHJ 70	PZ 1000KD20	NaHJ 70PZT	–	–	VNaHJ 70	–
Narva	NA...D	E27	0.98	Z 70...	NaHJ 70	PZ 1000KD20	NaHJ 70PZT	–	–	VNaHJ 70	–
Osram	NAVE.../E	E27	0.98	Z 70...	NaHJ 70	PZ 1000KD20	NaHJ 70PZT	–	–	VNaHJ 70	–
Osram	NAVE...4Y	E27	0.98	Z 70...	NaHJ 70	PZ 1000KD20	NaHJ 70PZT	–	–	VNaHJ 70	–
Osram	NAV-T	E27	0.98	Z 70...	NaHJ 70	PZ 1000KD20	NaHJ 70PZT	–	–	VNaHJ 70	–
Osram	NAV-T...4Y	E27	0.98	Z 70...	NaHJ 70	PZ 1000KD20	NaHJ 70PZT	–	–	VNaHJ 70	–
Osram	NAV-T...Super 4Y	E27	0.98	Z 70...	NaHJ 70	PZ 1000KD20	NaHJ 70PZT	–	–	VNaHJ 70	–
Osram	NAV-TS...Super 4Y	RX7s	0.98	Z 400...	NaHJ 70	PZ 1000KD20	NaHJ 70PZT	HZ 600K	NaHJ 70	VNaHJ 70	–
Philips	SON...Hg free	E27	0.98	Z 70...	NaHJ 70	PZ 1000KD20	NaHJ 70PZT	–	–	VNaHJ 70	–
Philips	SON...Pro	E27	0.98	Z 70...	NaHJ 70	PZ 1000KD20	NaHJ 70PZT	–	–	VNaHJ 70	–
Philips	SON-T...Plus	E27	0.98	Z 70...	NaHJ 70	PZ 1000KD20	NaHJ 70PZT	–	–	VNaHJ 70	–
Philips	SON-T...Pro	E27	0.98	Z 70...	NaHJ 70	PZ 1000KD20	NaHJ 70PZT	–	–	VNaHJ 70	–
Radium	RNPE	E27	0.98	Z 70...	NaHJ 70	PZ 1000KD20	NaHJ 70PZT	–	–	VNaHJ 70	–
Radium	RNP-T	E27	0.98	Z 70...	NaHJ 70	PZ 1000KD20	NaHJ 70PZT	–	–	VNaHJ 70	–
Radium	RNP-TS	RX7s	0.98	Z 400...	NaHJ 70	PZ 1000KD20	NaHJ 70PZT	HZ 600K	NaHJ 70	VNaHJ 70	–
Sylvania	SHP	E27	0.98	Z 70...	NaHJ 70	PZ 1000KD20	NaHJ 70PZT	–	–	VNaHJ 70	–
Sylvania	SHP-T	E27	0.98	Z 70...	NaHJ 70	PZ 1000KD20	NaHJ 70PZT	–	–	VNaHJ 70	–
Sylvania	SHP-TS	E27	0.98	Z 70...	NaHJ 70	PZ 1000KD20	NaHJ 70PZT	–	–	VNaHJ 70	–
Sylvania	SHP.../CO-E	E27	0.98	Z 70...	NaHJ 70	PZ 1000KD20	NaHJ 70PZT	–	–	VNaHJ 70	–
Sylvania	SHP-S	E27	0.98	Z 70...	NaHJ 70	PZ 1000KD20	NaHJ 70PZT	–	–	VNaHJ 70	–
Lamp output 100 W											
Aura	ST 100 W	E40	1.20	Z 250..., Z 400...	NaHJ100	PZ 1000KD20	NaHJ 100PZT	–	–	VNaHJ 100	–
Aura	SE 100 W	E40	1.20	Z 250..., Z 400...	NaHJ100	PZ 1000KD20	NaHJ 100PZT	–	–	VNaHJ 100	–
BLV	HST-SE	E40	1.20	Z 250..., Z 400...	NaHJ 100	PZ 1000KD20	NaHJ 100PZT	–	–	VNaHJ 100	–
GE	IU	E40	1.20	Z 250..., Z 400...	NaHJ 100	PZ 1000KD20	NaHJ 100PZT	–	–	VNaHJ 100	–
GE	IU...SBY	E40	1.20	Z 250..., Z 400...	NaHJ 100	PZ 1000KD20	NaHJ 100PZT	–	–	VNaHJ 100	–
GE	IU...XO	E40	1.20	Z 250..., Z 400...	NaHJ 100	PZ 1000KD20	NaHJ 100PZT	–	–	VNaHJ 100	–
Iwasaki	NH...F	E40	1.20	Z 250..., Z 400...	NaHJ 100	PZ 1000KD20	NaHJ 100PZT	–	–	VNaHJ 100	–
Iwasaki	NHT...F	E40	1.20	Z 250..., Z 400...	NaHJ 100	PZ 1000KD20	NaHJ 100PZT	–	–	VNaHJ 100	–

Lamp Table for Discharge Lamps

High-pressure sodium lamps (HS lamps)

Manufacturer	Designation	Base	Lamp current	Superimposed ignition system		Pulse ignition system		Instant restrike ignition system		Control gear unit	EB
				Ignitor	Ballast	Ignitor	Ballast	Ignitor	Ballast		
Lamp output 100 W											
Narva	NA	E40	1.20	Z 250..., Z 400...	NaHj 100	PZ 1000KD20	NaHj 100PZT	–	–	VNaHj 100	–
Narva	NA...D	E40	1.20	Z 250..., Z 400...	NaHj 100	PZ 1000KD20	NaHj 100PZT	–	–	VNaHj 100	–
Osram	NAVE	E40	1.20	Z 250..., Z 400...	NaHj 100	PZ 1000KD20	NaHj 100PZT	–	–	VNaHj 100	–
Osram	NAVE...Super 4Y	E40	1.20	Z 250..., Z 400...	NaHj 100	PZ 1000KD20	NaHj 100PZT	–	–	VNaHj 100	–
Osram	NAV-T	E40	1.20	Z 250..., Z 400...	NaHj 100	PZ 1000KD20	NaHj 100PZT	–	–	VNaHj 100	–
Osram	NAV-T...Super 4Y	E40	1.20	Z 250..., Z 400...	NaHj 100	PZ 1000KD20	NaHj 100PZT	–	–	VNaHj 100	–
Philips	SDW-T	PG12-1	1.30	ignitor/ stabiliser	NaH 100II	–	–	–	–	–	–
Philips	SON...Plus	E40	1.20	Z 250..., Z 400...	NaHj 100	PZ 1000KD20	NaHj 100PZT	–	–	VNaHj 100	–
Philips	SON...Pro	E40	1.20	Z 250..., Z 400...	NaHj 100	PZ 1000KD20	NaHj 100PZT	–	–	VNaHj 100	–
Philips	SON-T...Hg free	E40	1.20	Z 250..., Z 400...	NaHj 100	PZ 1000KD20	NaHj 100PZT	–	–	VNaHj 100	–
Philips	SON-T...Plus	E40	1.20	Z 250..., Z 400...	NaHj 100	PZ 1000KD20	NaHj 100PZT	–	–	VNaHj 100	–
Philips	SON-T...Pro	E40	1.20	Z 250..., Z 400...	NaHj 100	PZ 1000KD20	NaHj 100PZT	–	–	VNaHj 100	–
Radium	RNPE	E40	1.20	Z 250..., Z 400...	NaHj 100	PZ 1000KD20	NaHj 100PZT	–	–	VNaHj 100	–
Radium	RNP-T	E40	1.20	Z 250..., Z 400...	NaHj 100	PZ 1000KD20	NaHj 100PZT	–	–	VNaHj 100	–
Sylvania	SHPS	E40	1.20	Z 250..., Z 400...	NaHj 100	PZ 1000KD20	NaHj 100PZT	–	–	VNaHj 100	–
Sylvania	SHP-T	E40	1.20	Z 250..., Z 400...	NaHj 100	PZ 1000KD20	NaHj 100PZT	–	–	VNaHj 100	–
Sylvania	SHP-TS	E40	1.20	Z 250..., Z 400...	NaHj 100	PZ 1000KD20	NaHj 100PZT	–	–	VNaHj 100	–
Lamp output 150 W											
Aura	ST 150 W	E40	1.80	Z 250..., Z 400...	NaHj 150	PZ 1000KD20	NaHj 150PZT	–	–	VNaHj 150	–
Aura	SE 150 W	E40	1.80	Z 250..., Z 400...	NaHj 150	PZ 1000KD20	NaHj 150PZT	–	–	VNaHj 150	–
BLV	HST-DE	Fc2	1.80	Z 250..., Z 400...	NaHj 150	PZ 1000KD20	NaHj 150PZT	HZ 600K	NaHj 150	VNaHj 150	–
BLV	HST-DE	RX7s	1.80	Z 250..., Z 400...	NaHj 150	PZ 1000KD20	NaHj 150PZT	HZ 600K	NaHj 150	VNaHj 150	–
BLV	HST-SE	E40	1.80	Z 250..., Z 400...	NaHj 150	PZ 1000KD20	NaHj 150PZT	–	–	VNaHj 150	–
GE	IU	E40	1.80	Z 250..., Z 400...	NaHj 150	PZ 1000KD20	NaHj 150PZT	–	–	VNaHj 150	–
GE	IU...SBY	E40	1.80	Z 250..., Z 400...	NaHj 150	PZ 1000KD20	NaHj 150PZT	–	–	VNaHj 150	–
GE	IU...XO	E40	1.80	Z 250..., Z 400...	NaHj 150	PZ 1000KD20	NaHj 150PZT	–	–	VNaHj 150	–
Iwasaki	NH	E40	1.80	Z 250..., Z 400...	NaHj 150	PZ 1000KD20	NaHj 150PZT	–	–	VNaHj 150	–
Iwasaki	NHT	E40	1.80	Z 250..., Z 400...	NaHj 150	PZ 1000KD20	NaHj 150PZT	–	–	VNaHj 150	–
Narva	NA	E40	1.80	Z 250..., Z 400...	NaHj 150	PZ 1000KD20	NaHj 150PZT	–	–	VNaHj 150	–
Narva	NA...D	E40	1.80	Z 250..., Z 400...	NaHj 150	PZ 1000KD20	NaHj 150PZT	–	–	VNaHj 150	–
Osram	NAVE	E40	1.80	Z 250..., Z 400...	NaHj 150	PZ 1000KD20	NaHj 150PZT	–	–	VNaHj 150	–
Osram	NAVE...4Y	E40	1.80	Z 250..., Z 400...	NaHj 150	PZ 1000KD20	NaHj 150PZT	–	–	VNaHj 150	–
Osram	NAVE...Super 4Y	E40	1.80	Z 250..., Z 400...	NaHj 150	PZ 1000KD20	NaHj 150PZT	–	–	VNaHj 150	–
Osram	NAV-T	E40	1.80	Z 250..., Z 400...	NaHj 150	PZ 1000KD20	NaHj 150PZT	–	–	VNaHj 150	–
Osram	NAV-T...4Y	E40	1.80	Z 250..., Z 400...	NaHj 150	PZ 1000KD20	NaHj 150PZT	–	–	VNaHj 150	–
Osram	NAV-T...Super 4Y	E40	1.80	Z 250..., Z 400...	NaHj 150	PZ 1000KD20	NaHj 150PZT	–	–	VNaHj 150	–
Osram	NAV-TS...Super 4Y	RX7s	1.80	Z 250..., Z 400...	NaHj 150	PZ 1000KD20	NaHj 150PZT	HZ 600K	NaHj 150	VNaHj 150	–
Philips	SON...Hg free	E40	1.80	Z 250..., Z 400...	NaHj 150	PZ 1000KD20	NaHj 150PZT	–	–	VNaHj 150	–
Philips	SON...Plus	E40	1.80	Z 250..., Z 400...	NaHj 150	PZ 1000KD20	NaHj 150PZT	–	–	VNaHj 150	–
Philips	SON...Pro	E40	1.80	Z 250..., Z 400...	NaHj 150	PZ 1000KD20	NaHj 150PZT	–	–	VNaHj 150	–
Philips	SON...Comfort Pro	E40	1.82	Z 250..., Z 400...	NaHj 150	PZ 1000KD20	NaHj 150PZT	–	–	VNaHj 150	–
Philips	SON-T...Hg free	E40	1.80	Z 250..., Z 400...	NaHj 150	PZ 1000KD20	NaHj 150PZT	–	–	VNaHj 150	–
Philips	SON-T...Plus	E40	1.80	Z 250..., Z 400...	NaHj 150	PZ 1000KD20	NaHj 150PZT	–	–	VNaHj 150	–
Philips	SON-T...Pro	E40	1.80	Z 250..., Z 400...	NaHj 150	PZ 1000KD20	NaHj 150PZT	–	–	VNaHj 150	–
Philips	SON-T...Comfort Pro	E40	1.80	Z 250..., Z 400...	NaHj 150	PZ 1000KD20	NaHj 150PZT	–	–	VNaHj 150	–
Radium	RNPE	E40	1.80	Z 250..., Z 400...	NaHj 150	PZ 1000KD20	NaHj 150PZT	–	–	VNaHj 150	–
Radium	RNP-T	E40	1.80	Z 250..., Z 400...	NaHj 150	PZ 1000KD20	NaHj 150PZT	–	–	VNaHj 150	–
Radium	RNP-TS	RX7s	1.80	Z 250..., Z 400...	NaHj 150	PZ 1000KD20	NaHj 150PZT	HZ 600K	NaHj 150	VNaHj 150	–
Sylvania	SHPS	E40	1.80	Z 250..., Z 400...	NaHj 150	PZ 1000KD20	NaHj 150PZT	–	–	VNaHj 150	–
Sylvania	SHP-T	E40	1.80	Z 250..., Z 400...	NaHj 150	PZ 1000KD20	NaHj 150PZT	–	–	VNaHj 150	–
Sylvania	SHP-TS	E40	1.80	Z 250..., Z 400...	NaHj 150	PZ 1000KD20	NaHj 150PZT	–	–	VNaHj 150	–
Lamp output 250 W											
Aura	ST 250 W	E40	3.00	Z 250..., Z 400...	NaHj 250	PZ 1000KD20	NaHj 250PZT	–	–	VNaHj 250	–
Aura	SE 250 W	E40	3.00	Z 250..., Z 400...	NaHj 250	PZ 1000KD20	NaHj 250PZT	–	–	VNaHj 250	–
BLV	HST-DE	RX7s	3.00	Z 250..., Z 400...	NaHj 250	PZ 1000KD20	NaHj 250PZT	HZ 600K	NaHj 250	VNaHj 250	–
BLV	HST-SE	E40	3.00	Z 250..., Z 400...	NaHj 250	PZ 1000KD20	NaHj 250PZT	–	–	VNaHj 250	–
GE	IU	E40	3.00	Z 250..., Z 400...	NaHj 250	PZ 1000KD20	NaHj 250PZT	–	–	VNaHj 250	–
GE	IU...SBY	E40	3.00	Z 250..., Z 400...	NaHj 250	PZ 1000KD20	NaHj 250PZT	–	–	VNaHj 250	–
GE	IU...TD	RX7s	2.95	Z 250..., Z 400...	NaHj 250	PZ 1000KD20	NaHj 250PZT	HZ 600K	NaHj 250	VNaHj 250	–
GE	IU...XO	E40	2.95	Z 250..., Z 400...	NaHj 250	PZ 1000KD20	NaHj 250PZT	–	–	VNaHj 250	–

Lamp Table for Discharge Lamps

High-pressure sodium lamps (HS lamps)

Manufacturer	Designation	Base	Lamp current	Superimposed ignition system		Pulse ignition system		Instant restrike ignition system		Control gear unit	EB
				Ignitor	Ballast	Ignitor	Ballast	Ignitor	Ballast		
Lamp output 250 W											
Iwasaki	NH	E40	3.00	Z 250..., Z 400...	NaHj 250	PZ 1000KD20	NaHj 250PZT	–	–	VNaHj 250	–
Iwasaki	NHT	E40	3.00	Z 250..., Z 400...	NaHj 250	PZ 1000KD20	NaHj 250PZT	–	–	VNaHj 250	–
Narva	NA	E40	3.00	Z 250..., Z 400...	NaHj 250	PZ 1000KD20	NaHj 250PZT	–	–	VNaHj 250	–
Narva	NA...D	E40	3.00	Z 250..., Z 400...	NaHj 250	PZ 1000KD20	NaHj 250PZT	–	–	VNaHj 250	–
Osram	NAVE	E40	3.00	Z 250..., Z 400...	NaHj 250	PZ 1000KD20	NaHj 250PZT	–	–	VNaHj 250	–
Osram	NAVE...4Y	E40	3.00	Z 250..., Z 400...	NaHj 250	PZ 1000KD20	NaHj 250PZT	–	–	VNaHj 250	–
Osram	NAVE...Super 4Y	E40	3.00	Z 250..., Z 400...	NaHj 250	PZ 1000KD20	NaHj 250PZT	–	–	VNaHj 250	–
Osram	NAV-T	E40	3.00	Z 250..., Z 400...	NaHj 250	PZ 1000KD20	NaHj 250PZT	–	–	VNaHj 250	–
Osram	NAV-T...4Y	E40	3.00	Z 250..., Z 400...	NaHj 250	PZ 1000KD20	NaHj 250PZT	–	–	VNaHj 250	–
Osram	NAV-T...Super 4Y	E40	3.00	Z 250..., Z 400...	NaHj 250	PZ 1000KD20	NaHj 250PZT	–	–	VNaHj 250	–
Osram	NAV-Ts	RX7s	3.00	Z 250..., Z 400...	NaHj 250	PZ 1000KD20	NaHj 250PZT	HZ 600K	NaHj 250	VNaHj 250	–
Philips	SON...Hg free	E40	3.00	Z 250..., Z 400...	NaHj 250	PZ 1000KD20	NaHj 250PZT	–	–	VNaHj 250	–
Philips	SON...Plus	E40	3.00	Z 250..., Z 400...	NaHj 250	PZ 1000KD20	NaHj 250PZT	–	–	VNaHj 250	–
Philips	SON...Pro	E40	3.00	Z 250..., Z 400...	NaHj 250	PZ 1000KD20	NaHj 250PZT	–	–	VNaHj 250	–
Philips	SON...Comfort Pro	E40	3.00	Z 250..., Z 400...	NaHj 250	PZ 1000KD20	NaHj 250PZT	–	–	VNaHj 250	–
Philips	SON-T...Hg free	E40	3.00	Z 250..., Z 400...	NaHj 250	PZ 1000KD20	NaHj 250PZT	–	–	VNaHj 250	–
Philips	SON-T...Plus	E40	3.00	Z 250..., Z 400...	NaHj 250	PZ 1000KD20	NaHj 250PZT	–	–	VNaHj 250	–
Philips	SON-T...Pro	E40	3.00	Z 250..., Z 400...	NaHj 250	PZ 1000KD20	NaHj 250PZT	–	–	VNaHj 250	–
Philips	SON-T...Comfort Pro	E40	3.00	Z 250..., Z 400...	NaHj 250	PZ 1000KD20	NaHj 250PZT	–	–	VNaHj 250	–
Radium	RNPE	E40	3.00	Z 250..., Z 400...	NaHj 250	PZ 1000KD20	NaHj 250PZT	–	–	VNaHj 250	–
Radium	RNPT	E40	3.00	Z 250..., Z 400...	NaHj 250	PZ 1000KD20	NaHj 250PZT	–	–	VNaHj 250	–
Sylvania	SHP	E40	3.00	Z 250..., Z 400...	NaHj 250	PZ 1000KD20	NaHj 250PZT	–	–	VNaHj 250	–
Sylvania	SHP-T	E40	3.00	Z 250..., Z 400...	NaHj 250	PZ 1000KD20	NaHj 250PZT	–	–	VNaHj 250	–
Sylvania	SHP-S	E40	2.95	Z 250..., Z 400...	NaHj 250	PZ 1000KD20	NaHj 250PZT	–	–	VNaHj 250	–
Sylvania	SHP-TS	E40	2.95	Z 250..., Z 400...	NaHj 250	PZ 1000KD20	NaHj 250PZT	–	–	VNaHj 250	–
Lamp output 400 W											
Aura	ST 400 W	E40	4.40	Z 400..., Z 1000...	NaHj 400	PZ 1000KD20	NaHj 400PZT	–	–	VNaHj 400	–
Aura	SE 400 W	E40	4.40	Z 400..., Z 1000...	NaHj 400	PZ 1000KD20	NaHj 400PZT	–	–	VNaHj 400	–
BLV	HST-DE	RX7s	4.40	Z 400..., Z 1000...	NaHj 400	PZ 1000KD20	NaHj 400PZT	HZ 600K	NaHj 400	VNaHj 400	–
BLV	HST-SE	E40	4.40	Z 400..., Z 1000...	NaHj 400	PZ 1000KD20	NaHj 400PZT	–	–	VNaHj 400	–
GE	IU	E40	4.60	Z 400..., Z 1000...	NaHj 400	PZ 1000KD20	NaHj 400PZT	–	–	VNaHj 400	–
GE	IU...PSL	E40	4.30	Z 400..., Z 1000...	NaHj 400	PZ 1000KD20	NaHj 400PZT	–	–	VNaHj 400	–
GE	IU...SBY	E40	4.45	Z 400..., Z 1000...	NaHj 400	PZ 1000KD20	NaHj 400PZT	–	–	VNaHj 400	–
GE	IU...TD	RX7s	4.40	Z 400..., Z 1000...	NaHj 400	PZ 1000KD20	NaHj 400PZT	HZ 600K	NaHj 400	VNaHj 400	–
GE	IU...XO	E40	4.50	Z 400..., Z 1000...	NaHj 400	PZ 1000KD20	NaHj 400PZT	–	–	VNaHj 400	–
Iwasaki	NH	E40	4.60	Z 400..., Z 1000...	NaHj 400	PZ 1000KD20	NaHj 400PZT	–	–	VNaHj 400	–
Iwasaki	NHT	E40	4.60	Z 400..., Z 1000...	NaHj 400	PZ 1000KD20	NaHj 400PZT	–	–	VNaHj 400	–
Narva	NA	E40	4.45	Z 400..., Z 1000...	NaHj 400	PZ 1000KD20	NaHj 400PZT	–	–	VNaHj 400	–
Narva	NA...D	E40	4.45	Z 400..., Z 1000...	NaHj 400	PZ 1000KD20	NaHj 400PZT	–	–	VNaHj 400	–
Narva	NA...S	E40	4.45	Z 400..., Z 1000...	NaHj 400	PZ 1000KD20	NaHj 400PZT	–	–	VNaHj 400	–
Osram	NAVE	E40	4.45	Z 400..., Z 1000...	NaHj 400	PZ 1000KD20	NaHj 400PZT	–	–	VNaHj 400	–
Osram	NAVE...4Y	E40	4.45	Z 400..., Z 1000...	NaHj 400	PZ 1000KD20	NaHj 400PZT	–	–	VNaHj 400	–
Osram	NAVE...Super 4Y	E40	4.40	Z 400..., Z 1000...	NaHj 400	PZ 1000KD20	NaHj 400PZT	–	–	VNaHj 400	–
Osram	NAV-T	E40	4.40	Z 400..., Z 1000...	NaHj 400	PZ 1000KD20	NaHj 400PZT	–	–	VNaHj 400	–
Osram	NAV-T...4Y	E40	4.40	Z 400..., Z 1000...	NaHj 400	PZ 1000KD20	NaHj 400PZT	–	–	VNaHj 400	–
Osram	NAV-T...Super 4Y	E40	4.40	Z 400..., Z 1000...	NaHj 400	PZ 1000KD20	NaHj 400PZT	–	–	VNaHj 400	–
Osram	NAV-TS	RX7s	4.40	Z 400..., Z 1000...	NaHj 400	PZ 1000KD20	NaHj 400PZT	HZ 600K	NaHj 400	VNaHj 400	–
Osram	Plantastar	E40	4.40	Z 400..., Z 1000...	NaHj 400	PZ 1000KD20	NaHj 400PZT	–	–	VNaHj 400	–
Philips	SON...Hg free	E40	4.50	Z 400..., Z 1000...	NaHj 400	PZ 1000KD20	NaHj 400PZT	–	–	VNaHj 400	–
Philips	SON...Plus	E40	4.50	Z 400..., Z 1000...	NaHj 400	PZ 1000KD20	NaHj 400PZT	–	–	VNaHj 400	–
Philips	SON...Pro	E40	4.45	Z 400..., Z 1000...	NaHj 400	PZ 1000KD20	NaHj 400PZT	–	–	VNaHj 400	–
Philips	SON...Comfort Pro	E40	4.60	Z 400..., Z 1000...	NaHj 400	PZ 1000KD20	NaHj 400PZT	–	–	VNaHj 400	–
Philips	SON-T...Agro	E40	4.13	Z 400..., Z 1000...	NaHj 400	PZ 1000KD20	NaHj 400PZT	–	–	VNaHj 400	–
Philips	SON-T...Green Power	E40	4.23	Z 400..., Z 1000...	NaHj 400	PZ 1000KD20	NaHj 400PZT	–	–	VNaHj 400	–
Philips	SON-T...Hg free	E40	4.60	Z 400..., Z 1000...	NaHj 400	PZ 1000KD20	NaHj 400PZT	–	–	VNaHj 400	–
Philips	SON-T...Plus	E40	4.50	Z 400..., Z 1000...	NaHj 400	PZ 1000KD20	NaHj 400PZT	–	–	VNaHj 400	–
Philips	SON-T...Pro	E40	4.60	Z 400..., Z 1000...	NaHj 400	PZ 1000KD20	NaHj 400PZT	–	–	VNaHj 400	–
Philips	SON-T...Comfort Pro	E40	4.45	Z 400..., Z 1000...	NaHj 400	PZ 1000KD20	NaHj 400PZT	–	–	VNaHj 400	–
Radium	RNPE	E40	4.60	Z 400..., Z 1000...	NaHj 400	PZ 1000KD20	NaHj 400PZT	–	–	VNaHj 400	–
Radium	RNPT	E40	4.60	Z 400..., Z 1000...	NaHj 400	PZ 1000KD20	NaHj 400PZT	–	–	VNaHj 400	–

Lamp Table for Discharge Lamps

High-pressure sodium lamps (HS lamps)

Manufacturer	Designation	Base	Lamp current	Superimposed ignition system		Pulse ignition system		Instant restrike ignition system		Control gear unit	EB
				Ignitor	Ballast	Ignitor	Ballast	Ignitor	Ballast		
Lamp output 400 W											
Sylvania	SHP	E40	4.60	Z 400..., Z 1000...	NaHJ 400	PZ 1000KD20	NaHJ 400PZT	–	–	VNaHJ 400	–
Sylvania	SHP-S	E40	4.50	Z 400..., Z 1000...	NaHJ 400	PZ 1000KD20	NaHJ 400PZT	–	–	VNaHJ 400	–
Sylvania	SHP-TS	E40	4.50	Z 400..., Z 1000...	NaHJ 400	PZ 1000KD20	NaHJ 400PZT	–	–	VNaHJ 400	–
Sylvania	SHP-TS...Gro-Lux	E40	4.00	Z 400..., Z 1000...	NaHJ 400	PZ 1000KD20	NaHJ 400PZT	–	–	VNaHJ 400	–
Lamp output 600 W											
Aura	ST 600 W	E40	6.20	Z 1000...	NaHJ 600	PZ 1000KD20	NaHJ 600PZT	–	–	VNaHJ 600	–
Aura	SE 600 W	E40	6.20	Z 1000...	NaHJ 600	PZ 1000KD20	NaHJ 600PZT	–	–	VNaHJ 600	–
GE	IU...PSL	E40	6.00	Z 750...	NaH 600	PZ 1000KD20	NaH 600PZT	–	–	VNaH 600	–
GE	IU...XO	E40	6.00	Z 750...	NaH 600	PZ 1000KD20	NaH 600PZT	–	–	VNaH 600	–
GE	IU 400V/600W PSL	E40	3.60	Z 1000/400V	NaH 600/400V	PZ 1000/400V A5	NaH 600PZT/400V	–	–	–	–
Narva	NA	E40	6.20	Z 750...	NaH 600	PZ 1000KD20	NaH 600PZT	–	–	VNaH 600	–
Narva	NA...S	E40	6.20	Z 750...	NaH 600	PZ 1000KD20	NaH 600PZT	–	–	VNaH 600	–
Osram	NAV-T...Super 4Y	E40	6.20	Z 750...	NaH 600	PZ 1000KD20	NaH 600PZT	–	–	VNaH 600	–
Osram	Plantastar 600	E40	6.20	Z 750...	NaH 600	PZ 1000KD20	NaH 600PZT	–	–	VNaH 600	–
Philips	SON-T...Plus	E40	5.80	Z 750...	NaH 600	PZ 1000KD20	NaH 600PZT	–	–	VNaH 600	–
Philips	SON-T... Green Power	E40	6.30	Z 750...	NaH 600	PZ 1000KD20	NaH 600PZT	–	–	VNaH 600	–
Philips	SON-T 600W/400V Green Power	E40	3.62	Z 1000/400V	NaH 600/400V	PZ 1000/400V A5	NaH 600PZT/400V	–	–	–	–
Philips	SON-T 600W EL 400V Green Power*	E40	2.93-2.24	–	–	–	–	–	–	–	–
Radium	RNP-T	E40	6.20	Z 750...	NaH 600	PZ 1000KD20	NaH 600PZT	–	–	VNaH 600	–
Sylvania	SHP-TS	E40	5.90	Z 750...	NaH 600	PZ 1000KD20	NaH 600PZT	–	–	VNaH 600	–
Sylvania	SHP-TS...Gro-Lux	E40	5.50	Z 750...	NaH 600	PZ 1000KD20	NaH 600PZT	–	–	VNaH 600	–
Lamp output 750 W											
GE	IU...PSL	E40	7.00	Z 750...	NaH 750	PZ 1000KD20	NaH 750/600PZT	–	–	–	–
GE	IU 400V/750W PSL	E40	4.40	Z 1000/400V	NaH 750/400V	PZ 1000/400V A5	NaHJ 750PZT	–	–	–	–
Lamp output 1000 W											
Aura	ST 1000 W	E40	10.60	Z 1000...	NaHJ 1000	PZ 1000KD20	–	–	–	–	–
Aura	SE 1000 W	E40	10.30	Z 1000...	NaHJ 1000	PZ 1000KD20	–	–	–	–	–
GE	IU...T	E40	10.60	Z 1000...	NaH 1000, NaHJD 1000	PZ 1000KD20	–	–	–	–	–
GE	IU...D	E40	10.30	Z 1000...	NaH 1000, NaHJD 1000	PZ 1000KD20	–	–	–	–	–
GE	IU...TD	RX7s	10.30	Z 1000...	NaH 1000, NaHJD 1000	PZ 1000KD20	–	–	–	–	–
Iwasaki	NH	E40	10.30	Z 1000...	NaH 1000, NaHJD 1000	PZ 1000KD20	–	–	–	–	–
Iwasaki	NHT	E40	10.30	Z 1000...	NaH 1000, NaHJD 1000	PZ 1000KD20	–	–	–	–	–
Narva	NA	E40	10.60	Z 1000...	NaH 1000, NaHJD 1000	PZ 1000KD20	–	–	–	–	–
Narva	NA...D	E40	10.60	Z 1000...	NaH 1000, NaHJD 1000	PZ 1000KD20	–	–	–	–	–
Narva	NAT-VEG 1000/400V	E40	5.70	Z 1000/400V, Z 2000/400V	–	PZ 1000/400V A5	–	–	–	–	–
Osram	NAVE	E40	10.30	Z 1000...	NaH 1000, NaHJD 1000	PZ 1000KD20	–	–	–	–	–
Osram	NAV-T	E40	10.30	Z 1000...	NaH 1000, NaHJD 1000	PZ 1000KD20	–	–	–	–	–
Philips	SON...Pro	E40	10.30	Z 1000...	NaH 1000, NaHJD 1000	PZ 1000KD20	–	–	–	–	–
Philips	SON-T...Pro	E40	10.60	Z 1000...	NaH 1000, NaHJD 1000	PZ 1000KD20	–	–	–	–	–
Philips	SON-T 1000W EL 400V Green Power**	Wire	4-3.17	–	–	–	–	–	–	–	–
Radium	RNP-E	E40	10.30	Z 1000...	NaH 1000, NaHJD 1000	PZ 1000KD20	–	–	–	–	–
Radium	RNP-T	E40	10.30	Z 1000...	NaH 1000, NaHJD 1000	PZ 1000KD20	–	–	–	–	–
Sylvania	SHP-T	E40	10.60	Z 1000...	NaH 1000, NaHJD 1000	PZ 1000KD20	–	–	–	–	–
Sylvania	SHP-T...SBY	E40	10.60	Z 1000...	NaH 1000, NaHJD 1000	PZ 1000KD20	–	–	–	–	–

* Voltage range 210-275 V

** Voltage range 250-315 V

Lamp Table for Discharge Lamps

Metal halide lamps (HI lamps)

Manufacturer	Designation	Base	Lamp current	Superimposed ignition system		Pulse ignition system		Instant restrike ignition system		Control gear unit	EB
				Ignitor	Ballast	Ignitor	Ballast	Ignitor	Ballast		
Lamp output 70 W											
BLV	HIE	E27	0.90	Z 250..., Z 400...	NaHj 70	PZ 1000KD20	NaHj 70PZT	–	–	VNaHj 70	EHXc 70
BLV	HIE-P	E27	0.90	Z 250..., Z 400...	NaHj 70	PZ 1000KD20	NaHj 70PZT	–	–	VNaHj 70	EHXc 70
BLV	HIT	G12	0.90	Z 250..., Z 400...	NaHj 70	PZ 1000KD20	NaHj 70PZT	–	–	VNaHj 70	EHXc 70
BLV	HIT-DE	RX7s	0.90	Z 250..., Z 400...	NaHj 70	PZ 1000KD20	NaHj 70PZT	–	–	VNaHj 70	EHXc 70
GE	ARC	G12	0.95	Z 250..., Z 400...	NaHj 70	PZ 1000KD20	NaHj 70PZT	–	–	VNaHj 70	EHXc 70
GE	ARC	Rx7s	0.95	Z 250..., Z 400...	NaHj 70	PZ 1000KD20	NaHj 70PZT	HZ 600K	NaHj 70	VNaHj 70	EHXc 70
Iwasaki	M	E27	1.00	Z 250..., Z 400...	NaHj 70	PZ 1000KD20	NaHj 70PZT	–	–	VNaHj 70	EHXc 70
Iwasaki	MT	E27	1.00	Z 70...	NaHj 70	PZ 1000KD20	NaHj 70PZT	–	–	VNaHj 70	EHXc 70
Iwasaki	MT	G8.5	1.00	Z 250..., Z 400...	NaHj 70	PZ 1000KD20	NaHj 70PZT	–	–	VNaHj 70	EHXc 70
Iwasaki	MT	G12	1.00	Z 250..., Z 400...	NaHj 70	PZ 1000KD20	NaHj 70PZT	–	–	VNaHj 70	EHXc 70
Narva	NC...	E27; G12	0.90	Z 250..., Z 400...	NaHj 70	PZ 1000KD20	NaHj 70PZT	–	–	VNaHj 70	EHXc 70
Narva	NC...	RX7s	0.90	Z 250..., Z 400...	NaHj 70	PZ 1000KD20	NaHj 70PZT	HZ 600K	NaHj 70	VNaHj 70	EHXc 70
Osram	HQI-E	E27	0.95 - 1.00	Z 250..., Z 400...	NaHj 70	PZ 1000KD20	NaHj 70PZT	–	–	VNaHj 70	EHXc 70
Osram	HQI-T	G12	1.00	Z 250..., Z 400...	NaHj 70	PZ 1000KD20	NaHj 70PZT	–	–	VNaHj 70	EHXc 70
Osram	HQI-TS	RX7s	1.00	Z 250..., Z 400...	NaHj 70	PZ 1000KD20	NaHj 70PZT	HZ 600K	NaHj 70	VNaHj 70	EHXc 70
Philips	MHN-TD	RX7s	1.00	Z 250..., Z 400...	NaHj 70	PZ 1000KD20	NaHj 70PZT	HZ 600K	NaHj 70	VNaHj 70	EHXc 70
Philips	MHW-TD	RX7s	1.00	Z 250..., Z 400...	NaHj 70	PZ 1000KD20	NaHj 70PZT	HZ 600K	NaHj 70	VNaHj 70	EHXc 70
Radium	HRI-E	E27	0.95	Z 250..., Z 400...	NaHj 70	PZ 1000KD20	NaHj 70PZT	–	–	VNaHj 70	EHXc 70
Radium	HRI-T	G12	1.00	Z 250..., Z 400...	NaHj 70	PZ 1000KD20	NaHj 70PZT	–	–	VNaHj 70	EHXc 70
Radium	HRI-TS	RX7s	1.00	Z 250..., Z 400...	NaHj 70	PZ 1000KD20	NaHj 70PZT	HZ 600K	NaHj 70	VNaHj 70	EHXc 70
Sylvania	HSI-MP	E27	1.00	Z 250..., Z 400...	NaHj 70	PZ 1000KD20	NaHj 70PZT	–	–	VNaHj 70	EHXc 70
Sylvania	HSI-T	G12	0.95	Z 250..., Z 400...	NaHj 70	PZ 1000KD20	NaHj 70PZT	–	–	VNaHj 70	EHXc 70
Sylvania	HSI-TD	RX7s	0.98	Z 250..., Z 400...	NaHj 70	PZ 1000KD20	NaHj 70PZT	HZ 600K	NaHj 70	VNaHj 70	EHXc 70
Venture	HIE	E27	0.90	Z 250..., Z 400...	NaHj 70	PZ 1000KD20	NaHj 70PZT	–	–	VNaHj 70	EHXc 70
Venture	HIPE	E27	0.90	Z 250..., Z 400...	NaHj 70	PZ 1000KD20	NaHj 70PZT	–	–	VNaHj 70	EHXc 70
Venture	HIT	E27	0.90	Z 250..., Z 400...	NaHj 70	PZ 1000KD20	NaHj 70PZT	–	–	VNaHj 70	EHXc 70
Venture	HIT	G12	0.90	Z 250..., Z 400...	NaHj 70	PZ 1000KD20	NaHj 70PZT	–	–	VNaHj 70	EHXc 70
Venture	MH-DE	RX7s	1.00	Z 250..., Z 400...	NaHj 70	PZ 1000KD20	NaHj 70PZT	–	–	VNaHj 70	EHXc 70
Lamp output 100 W											
BLV	HIE	E27	1.20	Z 250..., Z 400...	NaHj 100	PZ 1000KD20	NaHj 100PZT	–	–	VNaHj 100	–
BLV	HIE-P	E27	1.20	Z 250..., Z 400...	NaHj 100	PZ 1000KD20	NaHj 100PZT	–	–	VNaHj 100	–
Narva	NC...	E27; E40	1.10	Z 250..., Z 400...	NaHj 100	PZ 1000KD20	NaHj 100PZT	–	–	VNaHj 100	–
Osram	HQI-E	E27	1.10	Z 250..., Z 400...	NaHj 100	PZ 1000KD20	NaHj 100PZT	–	–	VNaHj 100	–
Radium	HRI-E	E27	1.10	Z 250..., Z 400...	NaHj 100	PZ 1000KD20	NaHj 100PZT	–	–	VNaHj 100	–
Sylvania	HSI-MP	E27	1.15	Z 250..., Z 400...	NaHj 100	PZ 1000KD20	NaHj 100PZT	–	–	VNaHj 100	–
Venture	HIE	E27	1.10	Z 250..., Z 400...	NaHj 100	PZ 1000KD20	NaHj 100PZT	–	–	VNaHj 100	–
Venture	HIPE	E27; E40	1.10	Z 250..., Z 400...	NaHj 100	PZ 1000KD20	NaHj 100PZT	–	–	VNaHj 100	–
Venture	HIT	E27; E40	1.10	Z 250..., Z 400...	NaHj 100	PZ 1000KD20	NaHj 100PZT	–	–	VNaHj 100	–
Lamp output 150 W											
BLV	HIE	E27	1.80	Z 250..., Z 400...	NaHj 150	PZ 1000KD20	NaHj 150PZT	–	–	VNaHj 150	EHXc 150
BLV	HIE-P	E27	1.80	Z 250..., Z 400...	NaHj 150	PZ 1000KD20	NaHj 150PZT	–	–	VNaHj 150	EHXc 150
BLV	HIT	G12; E27; E40	1.80	Z 250..., Z 400...	NaHj 150	PZ 1000KD20	NaHj 150PZT	–	–	VNaHj 150	EHXc 150
BLV	HIT-DE	RX7s-24	1.80	Z 250..., Z 400...	NaHj 150	PZ 1000KD20	NaHj 150PZT	HZ 1000K	NaHj 150	VNaHj 150	EHXc 150
GE	ARC	G12	1.80	Z 250..., Z 400...	NaHj 150	PZ 1000KD20	NaHj 150PZT	–	–	VNaHj 150	EHXc 150
GE	ARC	RX7s-24	1.80	Z 250..., Z 400...	NaHj 150	PZ 1000KD20	NaHj 150PZT	HZ 1000K	NaHj 150	VNaHj 150	EHXc 150
Iwasaki	M	E27	1.90	Z 250..., Z 400...	NaHj 150	PZ 1000KD20	NaHj 150PZT	–	–	VNaHj 150	EHXc 150
Iwasaki	MT	E27	1.90	Z 250..., Z 400...	NaHj 150	PZ 1000KD20	NaHj 150PZT	–	–	VNaHj 150	EHXc 150
Iwasaki	MT	G12	1.90	Z 250..., Z 400...	NaHj 150	PZ 1000KD20	NaHj 150PZT	–	–	VNaHj 150	EHXc 150
Iwasaki	MTD	RX7s	1.90	Z 250..., Z 400...	NaHj 150	PZ 1000KD20	NaHj 150PZT	HZ 1000K	NaHj 150	VNaHj 150	EHXc 150
Narva	NC...	E27; E40; G12	1.80	Z 250..., Z 400...	NaHj 150	PZ 1000KD20	NaHj 150PZT	–	–	VNaHj 150	EHXc 150
Narva	NC...	RX7s	1.80	Z 250..., Z 400...	NaHj 150	PZ 1000KD20	NaHj 150PZT	HZ 1000K	NaHj 150	VNaHj 150	EHXc 150
Osram	HQI-E	E27	1.80	Z 250..., Z 400...	NaHj 150	PZ 1000KD20	NaHj 150PZT	–	–	VNaHj 150	EHXc 150
Osram	HQI-R	connector	1.80	Z 250..., Z 400...	NaHj 150	PZ 1000KD20	NaHj 150PZT	–	–	VNaHj 150	–
Osram	HQI-T	G12	1.80	Z 250..., Z 400...	NaHj 150	PZ 1000KD20	NaHj 150PZT	–	–	VNaHj 150	EHXc 150
Osram	HQI-TS	RX7s-24	1.80	Z 250..., Z 400...	NaHj 150	PZ 1000KD20	NaHj 150PZT	HZ 1000K	NaHj 150	VNaHj 150	EHXc 150
Philips	MHN-TD	RX7s	1.80	Z 250..., Z 400...	NaHj 150	PZ 1000KD20	NaHj 150PZT	HZ 1000K	NaHj 150	VNaHj 150	EHXc 150
Philips	MHW-TD	RX7s	1.80	Z 250..., Z 400...	NaHj 150	PZ 1000KD20	NaHj 150PZT	HZ 1000K	NaHj 150	VNaHj 150	EHXc 150
Radium	HRI-E	E27	1.80	Z 250..., Z 400...	NaHj 150	PZ 1000KD20	NaHj 150PZT	–	–	VNaHj 150	EHXc 150
Radium	HRI-T	G12	1.80	Z 250..., Z 400...	NaHj 150	PZ 1000KD20	NaHj 150PZT	–	–	VNaHj 150	EHXc 150
Radium	HRI-TS	RX7s	1.80	Z 250..., Z 400...	NaHj 150	PZ 1000KD20	NaHj 150PZT	HZ 1000K	NaHj 150	VNaHj 150	EHXc 150

Lamp Table for Discharge Lamps

Metal halide lamps (HI lamps)

Manufacturer	Designation	Base	Lamp current	Superimposed ignition system		Pulse ignition system		Instant restrike ignition system		Control gear unit	EB
				Ignitor	Ballast	Ignitor	Ballast	Ignitor	Ballast		
Lamp output 150 W											
Sylvania	HSI-MP	E27	1.80	Z 250..., Z 400...	NaHJ 150	PZ 1000KD20	NaHJ 150PZT	–	–	VNaHJ 150	EHXc 150
Sylvania	HSI-T	G12	1.80	Z 250..., Z 400...	NaHJ 150	PZ 1000KD20	NaHJ 150PZT	–	–	VNaHJ 150	EHXc 150
Sylvania	HSI-TD	RX7s	1.80	Z 250..., Z 400...	NaHJ 150	PZ 1000KD20	NaHJ 150PZT	HZ 1000K	NaHJ 150	VNaHJ 150	EHXc 150
Venture	HIE	E27	1.80	Z 250..., Z 400...	NaHJ 150	PZ 1000KD20	NaHJ 150PZT	–	–	VNaHJ 150	EHXc 150
Venture	HIPE	E27; E40	1.80	Z 250..., Z 400...	NaHJ 150	PZ 1000KD20	NaHJ 150PZT	–	–	VNaHJ 150	EHXc 150
Venture	HIT	E27; E40	1.80	Z 250..., Z 400...	NaHJ 150	PZ 1000KD20	NaHJ 150PZT	–	–	VNaHJ 150	EHXc 150
Venture	HIT	G12	1.80	Z 250..., Z 400...	NaHJ 150	PZ 1000KD20	NaHJ 150PZT	–	–	VNaHJ 150	EHXc 150
Venture	MH-DE	RX7s	1.80	Z 250..., Z 400...	NaHJ 150	PZ 1000KD20	NaHJ 150PZT	HZ 1000K	NaHJ 150	VNaHJ 150	EHXc 150
Lamp output 250 W											
BLV	HIE	E40	3.00	Z 250..., Z 400...	NaHJ 250	PZ 1000KD20	NaHJ 250PZT	–	–	VNaHJ 250	–
BLV	HIT	E40	3.00	Z 250..., Z 400...	NaHJ 250	PZ 1000KD20	NaHJ 250PZT	–	–	VNaHJ 250	–
BLV	HIT-DE	Fc2	3.00	Z 250..., Z 400...	NaHJ 250	PZ 1000KD20	NaHJ 250PZT	HZ 1000K	NaHJ 250	VNaHJ 250	–
GE	ARC250/T	E40	2.75	Z 250..., Z 400...	NaHJ 250	PZ 1000KD20	NaHJ 250PZT	–	–	VNaHJ 250	–
GE	ARC250/TD	Fc2	3.00	Z 250..., Z 400...	NaHJ 250	PZ 1000KD20	NaHJ 250PZT	HZ 1000K	NaHJ 250	VNaHJ 250	–
Narva	NC...	E40	2.15	Z 250..., Z 400...	NaHJ 250	PZ 1000KD20	NaHJ 250PZT	–	–	VNaHJ 250	–
Narva	NC...P	E40	2.15	–	–	PZI 1000/1	Q 250	–	–	–	–
Osram	HQI-E	E40	3.00	Z 250..., Z 400...	NaHJ 250	PZ 1000KD20	NaHJ 250PZT	–	–	VNaHJ 250	–
Osram	HQI-E/P	E40	3.00	Z 250..., Z 400...	NaHJ 250	PZ 1000KD20	NaHJ 250PZT	–	–	VNaHJ 250	–
Osram	HQI-T	E40	3.00	Z 250..., Z 400...	NaHJ 250	PZ 1000KD20	NaHJ 250PZT	–	–	VNaHJ 250	–
Osram	HQI-TS	Fc2	3.00	Z 250..., Z 400...	NaHJ 250	PZ 1000KD20	NaHJ 250PZT	HZ 1000K	NaHJ 250	VNaHJ 250	–
Philips	HPI Plus	E40	2.20	–	–	PZI 1000/1	Q 250	–	–	–	–
Philips	HPI-T	E40	2.15	–	–	PZI 1000/1	Q 250	–	–	–	–
Philips	MHN-TD	Fc2	3.00	Z 250..., Z 400...	NaHJ 250	PZ 1000KD20	NaHJ 250PZT	–	–	VNaHJ 250	–
Radium	HRI-E	E40	3.00	Z 250..., Z 400...	NaHJ 250	PZ 1000KD20	NaHJ 250PZT	–	–	VNaHJ 250	–
Radium	HRI-T	E40	3.00	Z 250..., Z 400...	NaHJ 250	PZ 1000KD20	NaHJ 250PZT	–	–	VNaHJ 250	–
Radium	HRI-TS	Fc2	3.00	Z 250..., Z 400...	NaHJ 250	PZ 1000KD20	NaHJ 250PZT	HZ 1000K	NaHJ 250	VNaHJ 250	–
Sylvania	HSI-HX	E40	2.10	–	–	PZI 1000/1	Q 250	–	–	–	–
Sylvania	HSI-T	E40	3.00	Z 250..., Z 400...	NaHJ 250	PZ 1000KD20	NaHJ 250PZT	–	–	VNaHJ 250	–
Sylvania	HSI-TD	Fc2	3.00	Z 250..., Z 400...	NaHJ 250	PZ 1000KD20	NaHJ 250PZT	HZ 1000K	NaHJ 250	VNaHJ 250	–
Sylvania	HSI-THX	E40	2.10	–	–	PZI 1000/1	Q 250	–	–	–	–
Sylvania	HSI-TSX	E40	2.90	Z 250..., Z 400...	NaHJ 250	PZ 1000KD20	NaHJ 250PZT	–	–	VNaHJ 250	–
Sylvania	HSI-SX	E40	2.90	Z 250..., Z 400...	NaHJ 250	PZ 1000KD20	NaHJ 250PZT	–	–	VNaHJ 250	–
Venture	HIE	E40	3.10	Z 250..., Z 400...	NaHJ 250	PZ 1000KD20	NaHJ 250PZT	–	–	VNaHJ 250	–
Venture	HIPE	E40	3.10	Z 250..., Z 400...	NaHJ 250	PZ 1000KD20	NaHJ 250PZT	–	–	VNaHJ 250	–
Venture	HIT	E40	3.10	Z 250..., Z 400...	NaHJ 250	PZ 1000KD20	NaHJ 250PZT	–	–	VNaHJ 250	–
Venture	HIT...EURO	E40	2.10	–	–	PZI 1000/1	Q 250	–	–	–	–
Venture	MH-DE	Fc2	3.10	Z 250..., Z 400...	NaHJ 250	PZ 1000KD20	NaHJ 250PZT	HZ 1000K	NaHJ 250	VNaHJ 250	–
Lamp output 400 W											
BLV	HIE	E40	4.00	Z 400..., Z 1000...	NaHJ 400	PZ 1000KD20	NaHJ 400PZT	–	–	VNaHJ 400	–
BLV	HIT	E40	4.00	Z 400..., Z 1000...	NaHJ 400	PZ 1000KD20	NaHJ 400PZT	–	–	VNaHJ 400	–
GE	ARC400/T	E40	4.35	Z 400..., Z 1000...	NaHJ 400	PZ 1000KD20	NaHJ 400PZT	–	–	VNaHJ 400	–
Narva	NC...	E40	3.25	Z 400..., Z 1000...	NaHJ 400	PZ 1000KD20	NaHJ 400PZT	–	–	VNaHJ 400	–
Narva	NC...P	E40	3.25	–	–	PZI 1000/1	Q 400	–	–	–	–
Osram	HQI-E	E40	3.50	Z 400..., Z 1000...	NaHJ 400	PZ 1000KD20	NaHJ 400PZT	–	–	VNaHJ 400	–
Osram	HQI-E/P	E40	3.50	Z 400..., Z 1000...	NaHJ 400	PZ 1000KD20	NaHJ 400PZT	–	–	VNaHJ 400	–
Osram	HQI-T	E40	3.60	Z 400..., Z 1000...	NaHJ 400	PZ 1000KD20	NaHJ 400PZT	–	–	VNaHJ 400	–
Osram	HQI-TS	Fc2	3.60	Z 400..., Z 1000...	NaHJ 400	PZ 1000KD20	NaHJ 400PZT	HZ 1000K	NaHJ 400	VNaHJ 400	–
Philips	HPI-T	E40	3.40	–	–	PZI 1000/1	Q 400	–	–	–	–
Philips	MH-T	E40	3.40	Z 400..., Z 1000...	NaHJ 400	PZ 1000KD20	NaHJ 400PZT	–	–	VNaHJ 400	–
Radium	HRI-BT	E40	4.00	Z 400..., Z 1000...	NaHJ 400	PZ 1000KD20	NaHJ 400PZT	–	–	VNaHJ 400	–
Radium	HRI-E	E40	4.60	Z 400..., Z 1000...	NaHJ 400	PZ 1000KD20	NaHJ 400PZT	–	–	VNaHJ 400	–
Radium	HRI-T	E40	4.60	Z 400..., Z 1000...	NaHJ 400	PZ 1000KD20	NaHJ 400PZT	–	–	VNaHJ 400	–
Radium	HRI-TS	Fc2	4.10	Z 400..., Z 1000...	NaHJ 400	PZ 1000KD20	NaHJ 400PZT	HZ 1000K	NaHJ 400	VNaHJ 400	–
Sylvania	HSI-HX	E40	3.40	–	–	PZI 1000/1	Q 400	–	–	–	–
Sylvania	HSI-T	E40	4.00	Z 400..., Z 1000...	NaHJ 400	PZ 1000KD20	NaHJ 400PZT	–	–	VNaHJ 400	–
Sylvania	HSI-THX	E40	3.40	–	–	PZI 1000/1	Q 400	–	–	–	–
Sylvania	HSI-TSX	E40	4.40	Z 400..., Z 1000...	NaHJ 400	PZ 1000KD20	NaHJ 400PZT	–	–	VNaHJ 400	–
Sylvania	HSI-SX	E40	4.40	Z 400..., Z 1000...	NaHJ 400	PZ 1000KD20	NaHJ 400PZT	–	–	VNaHJ 400	–
Venture	HIE	E40	3.20	Z 400..., Z 1000...	NaHJ 400	PZ 1000KD20	NaHJ 400PZT	–	–	VNaHJ 400	–
Venture	HIPE	E40	3.20	Z 400..., Z 1000...	NaHJ 400	PZ 1000KD20	NaHJ 400PZT	–	–	VNaHJ 400	–

Lamp Table for Discharge Lamps

Metal halide lamps (HI lamps)

Manufacturer	Designation	Base	Lamp current	Superimposed ignition system		Pulse ignition system		Instant restrike ignition system		Control gear unit	EB
				Ignitor	Ballast	Ignitor	Ballast	Ignitor	Ballast		
Lamp output 400 W											
Venture	HIT	E40	3.20	Z 400..., Z 1000...	NaHJ 400	PZ 1000KD20	NaHJ 400PZT	–	–	VNaHJ 400	–
Venture	HIT...EURO	E40	3.20	–	–	PZI 1000/1	Q 400	–	–	–	–
Lamp output 600 W											
Osram	HQI-TM	G22	6.10	Z1000	NaH 600	PZ 1000KD20	NaH 600PZT	–	–	VNaH 600	–
Radium	HRI-TM	G22	6.10	Z1000	NaH 600	PZ 1000KD20	NaH 600PZT	–	–	VNaH 600	–
Lamp output 1000 W											
BLV	HIT	E40	9.50	Z 1000..., Z 2000	NaHJ 1000	PZ 1000KD20	–	–	–	–	–
GE	SPL 1000	E40	9.50	Z 1000..., Z 2000	NaHJ 1000	PZ 1000KD20	–	–	–	–	–
Narva	NC...	E40	8.25	Z 1000..., Z 2000	NaHJ 1000	PZ 1000KD20	–	–	–	–	–
Narva	NC...P	E40	8.25	–	–	PZI 1000/1	Q 1000	–	–	–	–
Narva	NCT.../400V	E40	4.80	Z 1000/400V; Z 2000/400V	NaHJ 1000	–	–	–	–	–	–
Osram	HQI-TM	G22	9.50	Z 1000	NaHJ 1000	PZ 1000KD20	–	–	–	–	–
Osram	HQI-E	E40	9.50	Z 1000..., Z 2000	NaHJ 1000	PZ 1000KD20	–	–	–	–	–
Osram	HQI-T	E40	9.50	Z 1000..., Z 2000	NaHJ 1000	PZ 1000KD20	–	–	–	–	–
Osram	HQI-TS	cables	9.60	Z 1000..., Z 2000	NaHJ 1000	PZ 1000KD20	–	HZ 1000K	NaHJ 1000	–	–
Philips	HPI-T	E40	8.25	–	–	PZI 1000/1	Q 1000	–	–	–	–
Philips	MHN-LA	cables	9.30	Z 1000..., Z 2000	NaHJ 1000	PZ 1000KD20	–	HZ 1000K	NaHJ 1000	–	–
Radium	HRI-T	E40	9.50	Z 1000..., Z 2000	NaHJ 1000	PZ 1000KD20	–	–	–	–	–
Radium	HRI-TM	G22	9.50	Z 1000	NaHJ 1000	PZ 1000KD20	–	–	–	–	–
Radium	HRI-TS	cables	9.60	Z 1000..., Z 2000	NaHJ 1000	PZ 1000KD20	–	HZ 1000K	NaHJ 1000	–	–
Sylvania	HSI-THX	E40	8.25	–	–	PZI 1000/1	Q 1000	–	–	–	–
Venture	HIT	E40	9.15	Z 1000..., Z 2000	NaHJ1000	PZ 1000KD20	–	–	–	–	–
Venture	MBIL	RX7s	4.40	Z 2000/400V	–	–	–	HZ 2000K/ 400V	–	–	–
Lamp output 2000 W											
GE	SPL 2000/T	E40	10.30	Z 2000/400V	JD 2000	–	–	–	–	–	–
Osram	HQI-T/D	E40	10.30	Z 2000/400V	JD 2000	–	–	–	–	–	–
Osram	HQI-T...SN/380V	E40	8.80	–	–	–	QJ 2000	–	–	–	–
Osram	HQI-TS	cables	11.30	Z 2000/400V	JD 2000	–	–	HZ 2000K/ 400V	JD 2000	–	–
Osram	HQI-TS	cables	12.2	Z 2000/400V	JD 2000II/12.2	–	–	–	–	–	–
Philips	HPI-T 220V	E40	16.50	–	–	PZI 1000/1	JD 2000 I	–	–	–	–
Philips	HPI-T 380V	E40	9.10	–	–	–	QJ 2000	–	–	–	–
Philips	MHN-LA	cables	9.6-10.3	Z 2000/400V	JD 2000	–	–	HZ 2000K/ 400V	JD 2000	–	–
Philips	MHN-SA	X830R	11.30	Z 2000/400V	JD 2000	–	–	HZ 2000K/ 400V	JD 2000	–	–
Philips	MHN-SB 400V	cables	11.30	Z 2000/400V	JD 2000	–	–	HZ 2000K/ 400V	–	–	–
Radium	HRI-T 230V	E40	16.50 (2x8.25)	–	–	PZI 1000/1	JD 2000 I	–	–	–	–
Radium	HRI-T/D	E40	10.30	Z 2000/400V	JD 2000	–	–	–	–	–	–
Radium	HRI-TS	E40	10.30	Z 2000/400V	JD 2000	–	–	–	–	–	–
Radium	HRI-TS	cables	11.30	Z 2000/400V	JD 2000	–	–	HZ 2000K/ 400V*	JD 2000	–	–
Sylvania	HSI-T	E40	9.00	Z 2000/400V	JD 2000	–	–	–	–	–	–
Sylvania	HSI-TD	cables	11.30	Z 2000/400V	JD 2000	–	–	HZ 2000K/ 400V	JD 2000	–	–
Venture	MH	cables	10.30	Z 2000	JD 2000	–	–	–	–	–	–
Venture	MBIL	RX7s	10.30	Z 2000	JD 2000	–	–	–	–	–	–
Lamp output 3500 W											
Radium	HRI-T	E40	18.00	Z 3500/400V	JD 3500	–	–	–	–	–	–
Radium	HRI-TS	cables	18.00	Z 3500/400V	JD 3500	–	–	–	–	–	–

* Not suitable HRI-TS 2000W/N/L; HQI-TS 2000W/N/L

Lamp Table for Discharge Lamps

Ceramic discharge tube lamps (C-HI)

Manufacturer	Designation	Base	Lamp current	Superimposed ignition system		Pulse ignition system		Instant restrike ignition system		Control gear unit	EB
				Ignitor*	Ballast	Ignitor	Ballast	Ignitor	Ballast		
Lamp output 20 W											
GE	CMH2OMR16	GX10	0.21	–	–	–	–	–	–	–	EHXc 20
GE	CMH2OPAR	E27	0.23	–	–	–	–	–	–	–	EHXc 20
GE	CMH20T	G12	0.23	–	–	–	–	–	–	–	EHXc 20
GE	CMH20T	GU6.5	0.21	–	–	–	–	–	–	–	EHXc 20
GE	CMH20TC	G8.5	0.23	–	–	–	–	–	–	–	EHXc 20
GE	CMH20TC	G12	0.23	–	–	–	–	–	–	–	EHXc 20
Osram	HCI-PAR	E27	0.22	–	–	–	–	–	–	–	EHXc 20
Osram	HCI-R111	GX8.5	0.22	–	–	–	–	–	–	–	EHXc 20
Osram	HCI-TF	GU6.5	0.22	–	–	–	–	–	–	–	EHXc 20G.329
Osram	HCI-TC	G8.5	0.22	–	–	–	–	–	–	–	EHXc 20G.329
Philips	CDM-TM	PGJ5	0.22	–	–	–	–	–	–	–	–
Philips	CDM-R	GX10	0.22	–	–	–	–	–	–	–	EHXc 20G.329
Radium	RCC-TC	G8.5	0.22	–	–	–	–	–	–	–	EHXc 20G.329
Lamp output 35 W											
Aura	TT 35 W	E27	0.45	Z250..., Z400...	NaHJ 35	PZ 1000KD20	NaHJ 35PZT	–	–	VNaHJ 35	–
BLV	C-HIT	G12	0.50	Z 250..., Z 400...	NaHJ 35	PZ 1000KD20	NaHJ 35PZT	–	–	VNaHJ 35	EHXc 35
GE	CMH35PAR	E27	0.50	Z 250..., Z 400...	NaHJ 35	PZ 1000KD20	NaHJ 35PZT	–	–	VNaHJ 35	EHXc 35
GE	CMH35T	G12	0.50	Z 250..., Z 400...	NaHJ 35	PZ 1000KD20	NaHJ 35PZT	–	–	VNaHJ 35	EHXc 35
GE	CMH35TC	G8.5	0.50	Z 250..., Z 400...	NaHJ 35	PZ 1000KD20	NaHJ 35PZT	–	–	VNaHJ 35	EHXc 35
Osram	HCI-E/P	E27	0.50	Z 250..., Z 400...	NaHJ 35	PZ 1000KD20	NaHJ 35PZT	–	–	VNaHJ 35	EHXc 35
Osram	HCI-PAR	E27	0.50	Z 250..., Z 400...	NaHJ 35	PZ 1000KD20	NaHJ 35PZT	–	–	VNaHJ 35	EHXc 35
Osram	HCI-R111	GX8.5	0.50	Z 250..., Z 400...	NaHJ 35	PZ 1000KD20	NaHJ 35PZT	–	–	VNaHJ 35	EHXc 35
Osram	HCI-T	G12	0.50	Z 250..., Z 400...	NaHJ 35	PZ 1000KD20	NaHJ 35PZT	–	–	VNaHJ 35	EHXc 35
Osram	HCI-TC	G8.5	0.50	Z 250..., Z 400...	NaHJ 35	PZ 1000KD20	NaHJ 35PZT	–	–	VNaHJ 35	EHXc 35
Osram	HCI-TF	GU6.5	0.50	Z 250..., Z 400...	NaHJ 35	PZ 1000KD20	NaHJ 35PZT	–	–	VNaHJ 35	EHXc 35
Panasonic	CPS 35 W	GU8.5	0.44	–	–	–	–	–	–	–	EHXc 35
Philips	CDM-R	E27	0.53	Z 250..., Z 400...	NaHJ 35	PZ 1000KD20	NaHJ 35PZT	–	–	VNaHJ 35	EHXc 35
Philips	CDM-R111	GX8.5	0.53	Z 250..., Z 400...	NaHJ 35	PZ 1000KD20	NaHJ 35PZT	–	–	VNaHJ 35	EHXc 35
Philips	CDM-T	G12	0.53	Z 250..., Z 400...	NaHJ 35	PZ 1000KD20	NaHJ 35PZT	–	–	VNaHJ 35	EHXc 35
Philips	CDM-TC	G8.5	0.53	Z 250..., Z 400...	NaHJ 35	PZ 1000KD20	NaHJ 35PZT	–	–	VNaHJ 35	EHXc 35
Philips	CDM-R	GX10	0.53	Z 250..., Z 400...	NaHJ 35	PZ 1000KD20	NaHJ 35PZT	–	–	–	EHXc 35G
Radium	RCC-PAR	E27	0.50	Z 250..., Z 400...	NaHJ 35	PZ 1000KD20	NaHJ 35PZT	–	–	VNaHJ 35	EHXc 35
Radium	RCC-T	G12	0.50	Z 250..., Z 400...	NaHJ 35	PZ 1000KD20	NaHJ 35PZT	–	–	VNaHJ 35	EHXc 35
Radium	RCC-TC	G8.5	0.50	Z 250..., Z 400...	NaHJ 35	PZ 1000KD20	NaHJ 35PZT	–	–	VNaHJ 35	EHXc 35
Sylvania	CMI-T	G12	0.53	Z 250..., Z 400...	NaHJ 35	PZ 1000KD20	NaHJ 35PZT	–	–	VNaHJ 35	EHXc 35
Sylvania	CMI-TC	G8.5	0.53	Z 250..., Z 400...	NaHJ 35	PZ 1000KD20	NaHJ 35PZT	–	–	VNaHJ 35	EHXc 35
Venture	CMH35/T	G12	0.50	Z 250..., Z 400...	NaHJ 35	PZ 1000KD20	NaHJ 35PZT	–	–	VNaHJ 35	EHXc 35
Venture	CMH35/TC	G8.5	0.50	Z 250..., Z 400...	NaHJ 35	PZ 1000KD20	NaHJ 35PZT	–	–	VNaHJ 35	EHXc 35
Lamp output 50 W											
Aura	TT 50 W	E27	0.60	Z250..., Z400...	NaH 50	PZ1000KD20	NAH50PZT	–	–	VNaH 50	–
Philips	CDM-TC Elite	G8.5	0.59	Z 70...	NaH 50	–	–	–	–	VNaH 50	–
Philips	CDM-T Elite	G12	0.57	Z 70...	NaH 50	–	–	–	–	VNaH 50	–
Lamp output 70 W											
Aura	TT 70 W	E27	0.80	Z 250..., Z 400...	NaHJ 70	PZ 1000KD20	NaHJ 70PZT	–	–	VNaHJ 70	EHXd 70
BLV	C-HIT	G12	0.98	Z 250..., Z 400...	NaHJ 70	PZ 1000KD20	NaHJ 70PZT	–	–	VNaHJ 70	EHXc 70
BLV	C-HIT-DE	RX7s	0.90	Z 250..., Z 400...	NaHJ 70	PZ 1000KD20	NaHJ 70PZT	–	–	VNaHJ 70	EHXc 70
GE	CMH70E	E27	0.98	Z 250..., Z 400...	NaHJ 70	PZ 1000KD20	NaHJ 70PZT	–	–	VNaHJ 70	EHXc 70
GE	CMH70PAR	E27	0.98	Z 250..., Z 400...	NaHJ 70	PZ 1000KD20	NaHJ 70PZT	–	–	VNaHJ 70	EHXc 70
GE	CMH70T	G12	0.98	Z 250..., Z 400...	NaHJ 70	PZ 1000KD20	NaHJ 70PZT	–	–	VNaHJ 70	EHXc 70
GE	CMH70TC	G8.5	0.98	Z 250..., Z 400...	NaHJ 70	PZ 1000KD20	NaHJ 70PZT	–	–	VNaHJ 70	EHXc 70
GE	CMH70TD	Rx7s	0.98	Z 250..., Z 400...	NaHJ 70	PZ 1000KD20	NaHJ 70PZT	–	–	VNaHJ 70	EHXc 70
GE	CMH70TT	E27	0.98	Z 70...	NaHJ 70	PZ 1000KD20	NaHJ 70PZT	–	–	VNaHJ 70	EHXc 70
Osram	HCI-E/P	E27	0.98	Z 250..., Z 400...	NaHJ 70	PZ 1000KD20	NaHJ 70PZT	–	–	VNaHJ 70	EHXc 70
Osram	HCI-PAR	E27	0.97	Z 250..., Z 400...	NaHJ 70	PZ 1000KD20	NaHJ 70PZT	–	–	VNaHJ 70	EHXc 70
Osram	HCI-R111	GX8.5	0.98	Z 250..., Z 400...	NaHJ 70	PZ 1000KD20	NaHJ 70PZT	–	–	VNaHJ 70	EHXc 70
Osram	HCI-T	G12	0.96	Z 250..., Z 400...	NaHJ 70	PZ 1000KD20	NaHJ 70PZT	–	–	VNaHJ 70	EHXc 70
Osram	HCI-T/P	E27	0.98	Z 250..., Z 400...	NaHJ 70	PZ 1000KD20	NaHJ 70PZT	–	–	VNaHJ 70	EHXc 70
Osram	HCI-TC	G8.5	0.96	Z 250..., Z 400...	NaHJ 70	PZ 1000KD20	NaHJ 70PZT	–	–	VNaHJ 70	EHXc 70
Osram	HCI-TS	RX7s	0.95	Z 250..., Z 400...	NaHJ 70	PZ 1000KD20	NaHJ 70PZT	HZ 600K	NaHJ 70	VNaHJ 70	EHXc 70
Osram	HCI-TT	E27	0.92	Z 70...	NaHJ 70	PZ 1000KD20	NaHJ 70PZT	–	–	VNaHJ 70	EHXc 70

Lamp Table for Discharge Lamps

Ceramic discharge tube lamps (C-HI)

Manufacturer	Designation	Base	Lamp current	Superimposed ignition system		Pulse ignition system		Instant restrike ignition system		Control gear unit	EB
				Ignitor*	Ballast	Ignitor	Ballast	Ignitor	Ballast		
Lamp output 70 W											
Panasonic	CPS 70 W	GU8.5	0.86	–	–	–	–	–	–	–	EHXc 70
Philips	CDO-ET	E27	0.98	Z 70...	NaHJ 70	PZ 1000KD20	NaHJ 70PZT	–	–	VNaHJ 70	EHXc 70
Philips	CDO-TT	E27	1.00	Z 70...	NaHJ 70	PZ 1000KD20	NaHJ 70PZT	–	–	VNaHJ 70	–
Philips	CDM-R	E27	0.97	Z 250..., Z 400...	NaHJ 70	PZ 1000KD20	NaHJ 70PZT	–	–	VNaHJ 70	EHXc 70
Philips	CDM-R111	GX8.5	0.97	Z 250..., Z 400...	NaHJ 70	PZ 1000KD20	NaHJ 70PZT	–	–	VNaHJ 70	EHXc 70
Philips	CDM-T	G12	0.98	Z 250..., Z 400...	NaHJ 70	PZ 1000KD20	NaHJ 70PZT	–	–	VNaHJ 70	EHXc 70
Philips	CDM-TC	G8.5	0.98	Z 250..., Z 400...	NaHJ 70	PZ 1000KD20	NaHJ 70PZT	–	–	VNaHJ 70	EHXc 70
Philips	CDM-TD	RX7s	0.97	Z 250..., Z 400...	NaHJ 70	PZ 1000KD20	NaHJ 70PZT	HZ 600K	NaHJ 70	VNaHJ 70	EHXc 70
Philips	CDM-TP	PG12-2	0.98	Z 250..., Z 400...	NaHJ 70	PZ 1000KD20	NaHJ 70PZT	–	–	VNaHJ 70	EHXc 70
Radium	RCC-PAR	E27	0.98	Z 250..., Z 400...	NaHJ 70	PZ 1000KD20	NaHJ 70PZT	–	–	VNaHJ 70	EHXc 70
Radium	RCC-T	G12	0.96	Z 250..., Z 400...	NaHJ 70	PZ 1000KD20	NaHJ 70PZT	–	–	VNaHJ 70	EHXc 70
Radium	RCC-TC	G8.5	0.96	Z 250..., Z 400...	NaHJ 70	PZ 1000KD20	NaHJ 70PZT	–	–	VNaHJ 70	EHXc 70
Radium	RCC-TS	RX7s	0.98	Z 250..., Z 400...	NaHJ 70	PZ 1000KD20	NaHJ 70PZT	HZ 600K	NaHJ 70	VNaHJ 70	EHXc 70
Sylvania	CMI-T	G12	0.98	Z 250..., Z 400...	NaHJ 70	PZ 1000KD20	NaHJ 70PZT	–	–	VNaHJ 70	EHXc 70
Sylvania	CMI-TC	G8.5	0.98	Z 250..., Z 400...	NaHJ 70	PZ 1000KD20	NaHJ 70PZT	–	–	VNaHJ 70	EHXc 70
Sylvania	CMI-TD	RX7s	0.98	Z 250..., Z 400...	NaHJ 70	PZ 1000KD20	NaHJ 70PZT	–	–	VNaHJ 70	EHXc 70
Venture	CMH70/T	G12	0.98	Z 250..., Z 400...	NaHJ 70	PZ 1000KD20	NaHJ 70PZT	–	–	VNaHJ 70	EHXc 70
Venture	CMH70/TC	G8.5	0.98	Z 250..., Z 400...	NaHJ 70	PZ 1000KD20	NaHJ 70PZT	–	–	VNaHJ 70	EHXc 70
Venture	CMH70/TD	RX7s	0.98	Z 250..., Z 400...	NaHJ 70	PZ 1000KD20	NaHJ 70PZT	–	–	VNaHJ 70	EHXc 70
Venture	CMH70/TT	E27	0.98	Z 70...	NaHJ 70	PZ 1000KD20	NaHJ 70PZT	–	–	VNaHJ 70	EHXc 70
Lamp output 100 W											
Aura	TT 100 W	E40	1.30	Z 250..., Z 400...	NaHJ 100	PZ 1000KD20	NaHJ 100PZT	–	–	VNaHJ 100	–
GE	CMH100PAR	E26	1.10	Z 250..., Z 400...	NaHJ 100	PZ 1000KD20	NaHJ 100PZT	–	–	VNaHJ 100	–
GE	LUCALOX XO	E40	1.11	Z 250..., Z 400...	NaHJ 100	PZ 1000KD20	NaHJ 100PZT	–	–	VNaHJ 100	EHXc 100
Osram	HCI-E/P	E27	1.20	Z 250..., Z 400...	NaHJ 100	PZ 1000KD20	NaHJ 100PZT	–	–	VNaHJ 100	–
Osram	HCI-T/P	E27	1.20	Z 250..., Z 400...	NaHJ 100	PZ 1000KD20	NaHJ 100PZT	–	–	VNaHJ 100	–
Osram	HCI-T	G12	1.10	Z 250..., Z 400...	NaHJ 100	PZ 1000KD20	NaHJ 100PZT	–	–	VNaHJ 100	EHXc 100
Philips	CDO-ET	E40	1.20	Z 250..., Z 400...	NaHJ 100	PZ 1000KD20	NaHJ 100PZT	–	–	VNaHJ 100	–
Philips	CDO-TT	E40	1.20	Z 250..., Z 400...	NaHJ 100	PZ 1000KD20	NaHJ 100PZT	–	–	VNaHJ 100	–
Philips	CDM-T Elite	G12	1.14	Z 250..., Z 400...	NaHJ 100	PZ 1000KD20	NaHJ 100PZT	–	–	VNaHJ 100	EHXc 100
Lamp output 150 W											
Aura	TT 150 W	E40	1.70	Z 250..., Z 400...	NaHJ 150	PZ 1000KD20	NaHJ 150PZT	–	–	VNaHJ 150	–
BLV	C-HIT	G12	1.85	Z 250..., Z 400...	NaHJ 150	PZ 1000KD20	NaHJ 150PZT	–	–	VNaHJ 150	EHXc 150
BLV	C-HIT-DE	RX7s-24	1.80	Z 250..., Z 400...	NaHJ 150	PZ 1000KD20	NaHJ 150PZT	–	–	VNaHJ 150	–
GE	CMH150T	G12	1.85	Z 250..., Z 400...	NaHJ 150	PZ 1000KD20	NaHJ 150PZT	–	–	VNaHJ 150	EHXc 150
GE	CMH150TD	RX7s	1.80	Z 250..., Z 400...	NaHJ 150	PZ 1000KD20	NaHJ 150PZT	–	–	VNaHJ 150	EHXc 150
Osram	HCI-E/P	E27	1.80	Z 250..., Z 400...	NaHJ 150	PZ 1000KD20	NaHJ 150PZT	–	–	VNaHJ 150	EHXc 150
Osram	HCI-T	G12	1.80	Z 250..., Z 400...	NaHJ 150	PZ 1000KD20	NaHJ 150PZT	–	–	VNaHJ 150	EHXc 150
Osram	HCI-T/P	E27	1.80	Z 250..., Z 400...	NaHJ 150	PZ 1000KD20	NaHJ 150PZT	–	–	VNaHJ 150	EHXc 150
Osram	HCI-TS	RX7s-24	1.80	Z 250..., Z 400...	NaHJ 150	PZ 1000KD20	NaHJ 150PZT	HZ 1000K	NaHJ 150	VNaHJ 150	–
Osram	HCI-TT	E40	1.80	Z 250..., Z 400...	NaHJ 150	PZ 1000KD20	NaHJ 150PZT	–	–	VNaHJ 150	EHXc 150
Philips	CDO-ET	E40	1.80	Z 250..., Z 400...	NaHJ 150	PZ 1000KD20	NaHJ 150PZT	–	–	VNaHJ 150	EHXc 150
Philips	CDO-TT	E40	1.80	Z 250..., Z 400...	NaHJ 150	PZ 1000KD20	NaHJ 150PZT	–	–	VNaHJ 150	EHXc 150
Philips	CDM-T	G12	1.80-1.90	Z 250..., Z 400...	NaHJ 150	PZ 1000KD20	NaHJ 150PZT	–	–	VNaHJ 150	EHXc 150
Philips	CDM-TD	RX7s	1.80	Z 250..., Z 400...	NaHJ 150	PZ 1000KD20	NaHJ 150PZT	HZ 1000K	NaHJ 150	VNaHJ 150	EHXc 150
Philips	CDM-TP	PGX12-2	1.80	Z 250..., Z 400...	NaHJ 150	PZ 1000KD20	NaHJ 150PZT	–	–	VNaHJ 150	EHXc 150
Radium	RCC-T	G12	1.80	Z 250..., Z 400...	NaHJ 150	PZ 1000KD20	NaHJ 150PZT	HZ 1000K	NaHJ 150	VNaHJ 150	EHXc 150
Radium	RCC-TS	RX7s	1.80	Z 250..., Z 400...	NaHJ 150	PZ 1000KD20	NaHJ 150PZT	–	–	VNaHJ 150	EHXc 150
Sylvania	CMI-T	G12	1.82	Z 250..., Z 400...	NaHJ 150	PZ 1000KD20	NaHJ 150PZT	–	–	VNaHJ 150	EHXc 150
Sylvania	CMI-TD	RX7s-24	1.82	Z 250..., Z 400...	NaHJ 150	PZ 1000KD20	NaHJ 150PZT	–	–	VNaHJ 150	–
Venture	CMH150/T	G12	1.85	Z 250..., Z 400...	NaHJ 150	PZ 1000KD20	NaHJ 150PZT	–	–	VNaHJ 150	EHXc 150
Venture	CMH150/TD	RX7s	1.80	Z 250..., Z 400...	NaHJ 150	PZ 1000KD20	NaHJ 150PZT	–	–	VNaHJ 150	EHXc 150
Lamp output 250 W											
Aura	TT 250 W	E40	3.00	Z 250..., Z 400...	NaHJ 250	PZ 1000KD20	NaHJ 250PZT	–	–	VNaHJ 250	–
GE	CMH250E	E40	2.70	Z 250..., Z 400...	NaHJ 250	PZ 1000KD20	NaHJ 250PZT	–	–	VNaHJ 250	–
GE	CMH250P	E40	2.70	Z 250..., Z 400...	NaHJ 250	PZ 1000KD20	NaHJ 250PZT	–	–	VNaHJ 250	–
GE	CMH-TT	E40	2.90	Z 250..., Z 400...	NaHJ 250	PZ 1000KD20	NaHJ 250PZT	–	–	VNaHJ 250	–
Osram	HCI-E	E40	2.90	Z 250..., Z 400...	NaHJ 250	PZ 1000KD20	NaHJ 250PZT	–	–	VNaHJ 250	–
Osram	HCI-TC	E40	2.90	Z 250..., Z 400...	NaHJ 250	PZ 1000KD20	NaHJ 250PZT	–	–	VNaHJ 250	–
Osram	HCI-TM	G22	2.90	Z 250..., Z 400...	NaHJ 250	PZ 1000KD20	NaHJ 250PZT	HZ 1000K	NaHJ 250	VNaHJ 250	–
Osram	HCI-TS	E40; Fc2	3.00	Z 250..., Z 400...	NaHJ 250	PZ 1000KD20	NaHJ 250PZT	HZ 1000K	NaHJ 250	VNaHJ 250	–

Lamp Table for Discharge Lamps

Ceramic discharge tube lamps (C-HI)

Manufacturer	Designation	Base	Lamp current	Superimposed ignition system		Pulse ignition system		Instant restrike ignition system		Control gear unit	EB
				Ignitor*	Ballast	Ignitor	Ballast	Ignitor	Ballast		
Lamp output 250 W											
Philips	CDO-TT	E40	3.00	Z 250..., Z 400...	NaHJ 250	PZ 1000KD20	NaHJ 250PZT	–	–	VNaHJ 250	–
Philips	CDM-T	G12	3.00	Z 250..., Z 400...	NaHJ 250	PZ 1000KD20	NaHJ 250PZT	–	–	VNaHJ 250	–
Radium	RCC-E	E40	2.90	Z 250..., Z 400...	NaHJ 250	PZ 1000KD20	NaHJ 250PZT	–	–	VNaHJ 250	–
Radium	RCC-T	E40	2.80	Z 250..., Z 400...	NaHJ 250	PZ 1000KD20	NaHJ 250PZT	–	–	VNaHJ 250	–
Radium	RCC-TM	G22	2.90	Z 250..., Z 400...	NaHJ 250	PZ 1000KD20	NaHJ 250PZT	HZ 1000K	NaHJ 250	VNaHJ 250	–
Radium	RCC-TS	Fc2	3.00	Z 250..., Z 400...	NaHJ 250	PZ 1000KD20	NaHJ 250PZT	HZ 1000K	NaHJ 250	VNaHJ 250	–
Lamp output 400 W											
Aura	TT 400 W	E40	4.40	Z 400...	NaHJ 400	PZ 1000KD20	NaHJ 400PZT	–	–	VNaHJ 400	–
GE	CMHTT	E40	4.60	Z 400M..., Z 400...	NaHJ 400	PZ 1000KD20	NaHJ 400PZT	–	–	VNaHJ 400	–
Osram	HCI-TM	G22	4.45	Z 400M..., Z 400...	NaHJ 400	PZ 1000KD20	NaHJ 400PZT	–	–	VNaHJ 400	–

* Z 400 M VS power ignitor is not suitable for C-HI lamps

1

2

3

4

5

6

7

8

9

10

Lamp Table for Discharge Lamps

Mercury vapour lamps (HM lamps)

Manufacturer	Designation	Base	Current	Operating devices Ballasts (ignitor not required)	Capacitor at 50 Hz
Lamp output 50 W					
GE	H 50	E27, B22d	0.62	Q 50, Q 80/50	7 µF
Iwasaki	HF 50 PD	E27	0.62	Q 50, Q 80/50	7 µF
Narva	NF 50	E27	0.62	Q 50, Q 80/50	7 µF
Osram	HQL 50	E27	0.62	Q 50, Q 80/50	7 µF
Philips	HPL 50	E27	0.62	Q 50, Q 80/50	7 µF
Radium	HRL 50	E27	0.62	Q 50, Q 80/50	7 µF
Sylvania	HSL 50	E27	0.62	Q 50, Q 80/50	7 µF
Lamp output 80 W					
GE	H 80	E27, B22d-3*	0.80	Q 80, Q 80/50, Q 125/80	8 µF
Iwasaki	HF 80 PD	E27	0.80	Q 80, Q 80/50, Q 125/80	8 µF
Narva	NF 80	E27	0.80	Q 80, Q 80/50, Q 125/80	8 µF
Osram	HQL 80	E27	0.80	Q 80, Q 80/50, Q 125/80	8 µF
Philips	HPL 80	E27	0.80	Q 80, Q 80/50, Q 125/80	8 µF
Radium	HRL 80	E27	0.80	Q 80, Q 80/50, Q 125/80	8 µF
Sylvania	HSL 80	E27	0.80	Q 80, Q 80/50, Q 125/80	8 µF
Lamp output 125 W					
GE	H 125	E27, B22d-3*	1.15	Q 125, Q 125/80	10 µF
Iwasaki	HF 125 PD	E27	1.15	Q 125, Q 125/80	10 µF
Narva	NF 125	E27	1.15	Q 125, Q 125/80	10 µF
Osram	HQL 125	E27, E40	1.15	Q 125, Q 125/80	10 µF
Philips	HPL 125	E27	1.15	Q 125, Q 125/80	10 µF
Radium	HRL 125	E27	1.15	Q 125, Q 125/80	10 µF
Sylvania	HSL 125	E27, B22d-3*	1.15	Q 125, Q 125/80	10 µF
Lamp output 250 W					
GE	H 250	E40	2.15	Q 250, U-Q 250/150	18 µF
Iwasaki	HF 250 PD	E40	2.15	Q 250, U-Q 250/150	18 µF
Narva	NF 250	E40	2.15	Q 250, U-Q 250/150	18 µF
Osram	HQL 250	E40	2.15	Q 250, U-Q 250/150	18 µF
Philips	HPL 250	E40	2.15	Q 250, U-Q 250/150	18 µF
Radium	HRL 250	E40	2.15	Q 250, U-Q 250/150	18 µF
Sylvania	HSL 250	E40	2.15	Q 250, U-Q 250/150	18 µF
Lamp output 400 W					
GE	H 400	E40	3.25	Q 400, U-Q 400/250	25 µF
Iwasaki	HF 400 PD	E40	3.25	Q 400, U-Q 400/250	25 µF
Narva	NF 400	E40	3.25	Q 400, U-Q 400/250	25 µF
Osram	HQL 400	E40	3.25	Q 400, U-Q 400/250	25 µF
Philips	HPL 400	E40	3.25	Q 400, U-Q 400/250	25 µF
Radium	HRL 400	E40	3.25	Q 400, U-Q 400/250	25 µF
Sylvania	HSL 400	E40	3.25	Q 400, U-Q 400/250	25 µF
Lamp output 700 W					
GE	H 700	E40	5.45	Q 700	40 µF
Iwasaki	HF 700 PD	E40	5.40	Q 700	40 µF
Narva	NF 700	E40	5.40	Q 700	40 µF
Osram	HQL 700	E40	5.40	Q 700	40 µF
Philips	HPL 700	E40	5.40	Q 700	40 µF
Radium	HRL 700	E40	5.40	Q 700	40 µF
Sylvania	HSL 700	E40	5.40	Q 700	40 µF
Lamp output 1000 W					
GE	H 1000	E40	7.50	Q 1000	60 µF
Iwasaki	HF 1000 PD	E40	7.50	Q 1000	60 µF
Narva	NF 1000	E40	7.50	Q 1000	60 µF
Osram	HQL 1000	E40	7.50	Q 1000	60 µF
Philips	HPL 1000	E40	7.50	Q 1000	60 µF
Radium	HRL 1000	E40	7.50	Q 1000	60 µF
Sylvania	HSL 1000	E40	7.50	Q 1000	60 µF

* The VS range does not include a lampholder for base B22d-3

Energy efficiency classification

The commission's regulation (EC) No. 245/2009 dated 18 March 2009 implementing Directive 2005/32/EC of the European Parliament and of the Council with regard to defining ecodesign requirements for fluorescent lamps without integrated ballast, high-pressure discharge lamps and for ballasts and luminaires needed for their operation, and repealing Directive 2000/55/EC of the European Parliament and of the Council (official title), has created a legal framework in the EU that defines fundamental requirements for operating efficient lighting technology products.

Although the Regulation predominantly applies to general lighting, it is also product-orientated and thus independent of any specific application. The efficiency and performance requirements (specifications governing performance features) apply to fluorescent lamps without integrated ballast, high-pressure discharge lamps as well as ballasts and luminaires needed to operate these lamps. A brief overview of the requirements governing high-pressure discharge lamps is provided in the following table (excerpt from the CELMA guide).

Stage	Requirements governing	
1 13.04.2010	Ballasts	<ul style="list-style-type: none"> No special requirements
Interim Stage 13.09.2010	Luminaires	<ul style="list-style-type: none"> After 18 months: technical information must be made available, both online and in luminaire documentation (for luminaires > 2,000 Lumens)
2 13.04.2012	Ballasts	<ul style="list-style-type: none"> Introduction of minimum energy-efficiency index values for HID ballasts and their labelling: <ul style="list-style-type: none"> $P < 30 \text{ W} - \eta \geq 65\%$ $30 < P < 75 \text{ W} - \eta \geq 75\%$ $75 < P < 105 \text{ W} - \eta \geq 80\%$ $105 < P < 405 \text{ W} - \eta \geq 85\%$ $P > 405 \text{ W} - \eta \geq 90\%$ HID ballasts to be labelled: EEL=A3
	Luminaires	<ul style="list-style-type: none"> Luminaire designs must permit the integration of 3rd-stage ballasts. Exception: luminaires > IP4X
at the latest by 13.04.2014	Revision of the regulation	
	Technological progress as well as the sum of the experience gained during the implementation of the Regulation be taken into consideration during the revision process.	
3 13.04.2017	Ballasts	<ul style="list-style-type: none"> Minimum energy-efficiency index values will be raised: <ul style="list-style-type: none"> $P < 30 \text{ W} - \eta \geq 78\%$ $30 < P < 75 \text{ W} - \eta \geq 85\%$ $75 < P < 105 \text{ W} - \eta \geq 87\%$ $105 < P < 405 \text{ W} - \eta \geq 90\%$ $P > 405 \text{ W} - \eta \geq 92\%$ HID ballasts to be labelled: A2
	Luminaires	<ul style="list-style-type: none"> All luminaire designs must permit the integration of 3rd-stage ballasts.

1

2

3

4

5

6

7

8

9

10

WARM START,
DIMMABLE AND
INSTANT START



ELECTRONIC BALLASTS

Operating fluorescent lamps with electronic ballasts yields numerous advantages with regard to efficiency and convenience. Further details are provided on the respective product pages and the technical appendix.

The brightness of fluorescent lamps can also be regulated with the help of dimmable electronic ballasts. Adjusting lamp wattage leads to a further reduction of energy consumption and of the associated costs. The corresponding ELXd units from Vossloh-Schwabe enable conventional 1-10 V control units to be connected via a bipolar 1-10 V dimmer interface.

Moreover, Vossloh-Schwabe's product range also contains electronic ballasts that can be dimmed using conventional light sensors or polarity-independent dimmer interfaces via DALI-compatible control units. Both interfaces (1-10 V and DALI) were developed in accordance with EN 60929. Under consideration of the maximum current of the respective control unit, it is also possible to operate several electronic ballasts in parallel.

3

Electronic Ballasts for TC and T Lamps

Electronic ballasts for compact fluorescent lamps

ELXc - Warm start - Linear casing shape	126
ELXd - Dimmable - Linear casing shape	127-128
ELXc - Warm start - Compact casing shape	129-137
ECO EffectLine	135
ELXd - Dimmable - Compact casing shape	138-141

Electronic ballasts for tubular fluorescent lamps

ELXc - Warm start - Linear casing shape	142-146
EffectLine and EffectLine II	144
New T5 EffectLine	145
ECO EffectLine	146
ELXd - Dimmable - Linear casing shape	147-149

Accessories for dimmable electronic built-in ballasts

150

Technical details for fluorescent lamps

226-253

General technical details	366-374
Glossary	375-377

1

2

3

4

5

6

7

8

9

10

ELXc – Warm Start for TC-F, TC-L Lamps

Electronic built-in ballasts

Casing: metal

Power factor: > 0.96

DC voltage

for operation: 176–264 V

for ignition: 198–264 V

(ELXc 180.866, 280.538: DC voltage cannot be reduced to 176 V)

Push-in terminals: 0.5–1 mm²

For the automatic luminaire wiring:

IDC terminals for leads HO5V-U 0.5

RFI-suppressed

For luminaires of protection class I

Degree of protection: IP20

For lighting systems with

high switching frequency (> 5/day)

EOL shut down approved acc. to EN 61347 Test 2

M10/M11

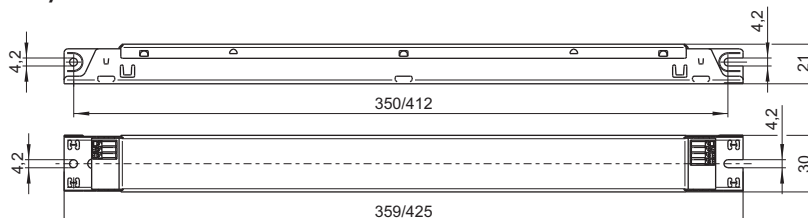

- T5 TC BUILT-IN 1–10 V
 T8 INDEPENDENT DALI/PUSH

Lamp				Electronic ballast							System	
Output W	Type	Base	Power consumption W	Type	Ref. No.	Voltage AC 50, 60 Hz V±10%	Energy efficiency	Ambient temperature t _a (°C)	Casing temperature t _c (°C)	Casing	Output W	Luminous factor %
18	TC-F/L	2G10/2G11	1 x 16.0	ELXc 140.862	188140	220–240	A2	-15 to 55	max. 70	M10	19.0	109.0
2x18	TC-F/L	2G10/2G11	2 x 16.0	ELXc 240.863	188616	220–240	A2 BAT	-15 to 55	max. 70	M10	35.0	105.3
24	TC-F/L	2G10/2G11	1 x 22.0	ELXc 140.862	188140	220–240	A2	-15 to 55	max. 70	M10	27.0	109.0
2x24	TC-F/L	2G10/2G11	2 x 22.0	ELXc 240.863	188616	220–240	A2 BAT	-15 to 55	max. 70	M10	51.0	106.8
36	TC-F/L	2G10/2G11	1 x 32.0	ELXc 140.862	188140	220–240	A2	-15 to 55	max. 70	M10	35.0	101.0
2x36	TC-F/L	2G10/2G11	2 x 32.0	ELXc 240.863	188616	220–240	A2 BAT	-15 to 55	max. 70	M10	71.0	98.7
40	TC-L	2G11	1 x 40.0	ELXc 140.862	188140	220–240	A2	-15 to 55	max. 70	M10	46.0	104.0
2x40	TC-L	2G11	2 x 40.0	ELXc 240.863	188616	220–240	A2 BAT	-15 to 55	max. 70	M10	89.0	103.6
55	TC-L	2G11	1 x 55.0	ELXc 180.866	188144	220–240	A2 BAT	-15 to 55	max. 70	M10	62.0	107.3
2x55	TC-L	2G11	2 x 50.0	ELXc 254.865	188618	220–240	A2 BAT	-15 to 50	max. 70	M10	112.0	92.9
			2 x 55.0	ELXc 280.538	188619	220–240	A2 BAT	-15 to 50	max. 70	M11	120.0	100.0
80	TC-L	2G11	1 x 80.0	ELXc 180.866	188144	220–240	A2 BAT	-15 to 55	max. 70	M10	87.0	97.6
2x80	TC-L	2G11	2 x 80.0	ELXc 280.538	188619	220–240	A2 BAT	-15 to 50	max. 70	M11	175.0	100.0

Circuit diagrams see pages 238–241

ELXd – Dimmable for TC-F, TC-L Lamps

Electronic built-in ballasts

Casing: metal

Dimming range:

approx. 1–100% of lamp power

Power factor: ≥ 0.95 at 100% operation

DC voltage

for operation: 154–276 V (M22, M23, M24)

for operation: 176–264 V (M9)

for ignition: 198–264 V

Push-in terminals: 0,5–1 mm²

For the automatic luminaire wiring:

IDC terminals for leads H05V-U 0.5

RFI-suppressed

For luminaires of protection class I

Degree of protection: IP20

Fixing holes for screws M4

for lateral or base mounting

For lighting systems with

high switching frequency (> 5/day)

EOL shut down approved acc. to EN 61347 Test 2

M9

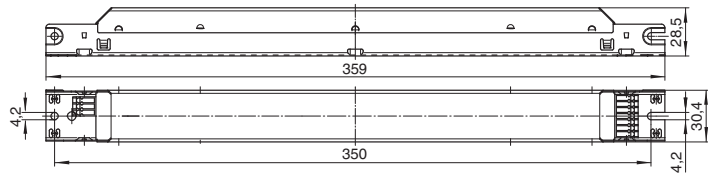

M23

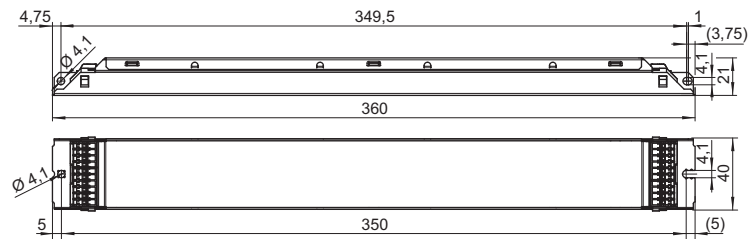

M22/M24

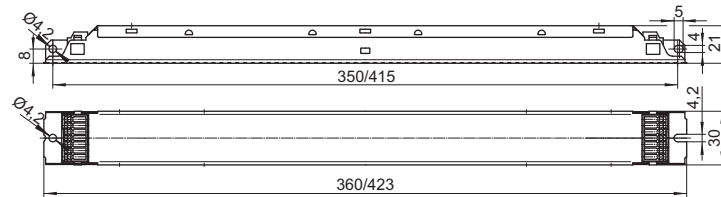

- 1
- 2
- 3
- 4
- 5
- 6
- 7
- 8
- 9
- 10

Electronic Ballasts for TC and T Lamps

ELXd – Dimmable 1–10 V for TC-F, TC-L lamps

Control voltage: DC 1–10 V

acc. to EN 60929 with earth leakage current 0.5 mA

(protected if connected to mains voltage)

For use with open- or closed-loop control units

T5 TC BUILT-IN 1–10 V
 T8 INDEPENDENT DALI/PUSH

Lamp				Electronic ballast							System	
Output W	Type	Base	Power consumption W	Type	Ref. No.	Voltage AC 50, 60 Hz V±10%	Energie efficiency	Ambient temperature t _a (°C)	Casing temperature t _c (°C)	Casing	Output W	Luminous factor %
18	TC-F/L	2G10/2G11	1 x 16.0	ELXd 118.718	188873	220–240	EEL=A1	10 to 50	max. 70	M9	18.0	94.0
2x18	TC-F/L	2G10/2G11	2 x 16.0	ELXd 218.719	188874	220–240	EEL=A1	10 to 50	max. 70	M9	36.0	90.6
24	TC-F/L	2G10/2G11	1 x 22.0	ELXd 118.718	188873	220–240	EEL=A1	10 to 50	max. 70	M9	27.0	96.6
			1 x 23.0	ELXd 124.607	188336	220–240	A1 BAT	10 to 50	max. 75	M22	26.0	100.0
2x24	TC-F/L	2G10/2G11	2 x 22.0	ELXd 218.719	188874	220–240	EEL=A1	10 to 50	max. 70	M9	52.0	100.8
			2 x 23.0	ELXd 224.608	188337	220–240	A1 BAT	10 to 50	max. 75	M24	49.0	100.0
3x24	TC-F/L	2G10/2G11	3 x 24.0	ELXd 324.623	188597	220–240	A1 BAT	10 to 50	max. 75	M23	73.4	100.0
4x24	TC-F/L	2G10/2G11	4 x 24.0	ELXd 424.624	188598	220–240	A1 BAT	10 to 50	max. 75	M23	97.6	100.0
36	TC-F/L	2G10/2G11	1 x 32.0	ELXd 136.720	188875	220–240	A1 BAT	10 to 50	max. 70	M9	37.3	93.5
2x36	TC-F/L	2G10/2G11	2 x 32.0	ELXd 236.721	188876	220–240	EEL=A1	10 to 50	max. 70	M9	72.0	92.6
40	TC-L	2G11	1 x 38.0	ELXd 139.609	188338	220–240	A1 BAT	10 to 50	max. 75	M22	42.0	100.0
2x40	TC-L	2G11	2 x 38.0	ELXd 239.610	188339	220–240	A1 BAT	10 to 50	max. 75	M24	82.0	100.0
55	TC-L	2G11	1 x 51.0	ELXd 158.722	188877	220–240	EEL=A1	10 to 50	max. 70	M9	56.0	92.5
			1 x 54.0	ELXd 154.611	188340	220–240	A1 BAT	10 to 50	max. 75	M22	59.0	100.0
2x55	TC-L	2G11	2 x 54.0	ELXd 254.612	188341	220–240	A1 BAT	10 to 50	max. 75	M24	115.0	100.0
80	TC-L	2G11	1 x 80.0	ELXd 180.613	188342	220–240	A1 BAT	10 to 50	max. 75	M22	88.0	100.0

Circuit diagrams see pages 238–241

ELXd – Dimmable with push key or DALI for TC-F, TC-L lamps

Complete implementation of the DALI-standard:

addressable, memory store for scenes and groups,

revertive information communication, physical and

RND-selection, standardized lamp characteristic

Low-power design ensures very low standby

power consumption

standby power consumption: ≤ 0.2 W

T5 TC BUILT-IN 1–10 V
 T8 INDEPENDENT DALI/PUSH

Lamp				Electronic ballast							System	
Output W	Type	Base	Power consumption W	Type	Ref. No.	Voltage AC 50, 60 Hz V±10%	Energie efficiency	Ambient temperature t _a (°C)	Casing temperature t _c (°C)	Casing	Output W	Luminous factor %
24	TC-F/L	2G10/2G11	1 x 23.0	ELXd 124.600	188329	220–240	A1 BAT	10 to 50	max. 75	M22	26.0	100.0
2x24	TC-F/L	2G10/2G11	2 x 23.0	ELXd 224.601	188330	220–240	A1 BAT	10 to 50	max. 75	M24	49.0	100.0
3x24	TC-F/L	2G10/2G11	3 x 23.0	ELXd 324.626	188600	220–240	A1 BAT	10 to 50	max. 75	M23	73.4	100.0
4x24	TC-F/L	2G10/2G11	4 x 23.0	ELXd 424.628	188602	220–240	A1 BAT	10 to 50	max. 75	M23	97.6	100.0
40	TC-L	2G11	1 x 38.0	ELXd 139.602	188331	220–240	A1 BAT	10 to 50	max. 75	M22	42.0	100.0
2x40	TC-L	2G11	2 x 38.0	ELXd 239.621	188350	220–240	A1 BAT	10 to 50	max. 75	M24	82.0	100.0
55	TC-L	2G11	1 x 54.0	ELXd 154.603	188332	220–240	A1 BAT	10 to 50	max. 75	M22	59.0	100.0
2x55	TC-L	2G11	2 x 54.0	ELXd 254.604	188333	220–240	A1 BAT	10 to 50	max. 75	M24	115.0	100.0
80	TC-L	2G11	1 x 80.0	ELXd 180.605	188334	220–240	A1 BAT	10 to 50	max. 75	M22	88.0	100.0

Circuit diagrams see pages 238–241

ELXc – Warm Start for Compact Fluorescent Lamps

Electronic ballasts

Casing: heat-resistant polyamide (K2, K3)
or heat-resistant polycarbonate (K2.1, K4)

DC voltage

for operation: 176–264 V

for ignition: 198–264 V

(ELXc 242.837: DC voltage cannot
be reduced to 176 V)

Power factor: > 0.96 (K2.1: 0.98)

Push-in terminals with lever opener: 0.5–1.5 mm²

RFI-suppressed

Constant power consumption

For luminaires of protection class I

Degree of protection: IP20

Fixing brackets for screws M4

for lateral or base mounting

For lighting systems with

high switching frequency (> 5/day)

EOL shut down approved acc. to

EN 61347 Test 2



Electronic built-in ballasts

K2

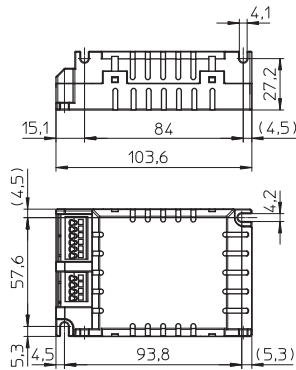

K3

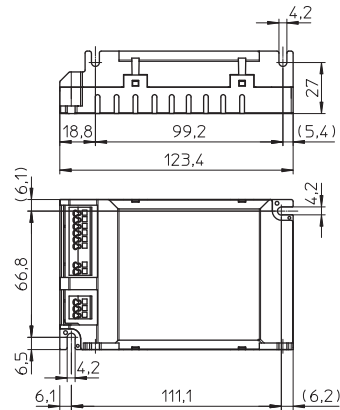

K4

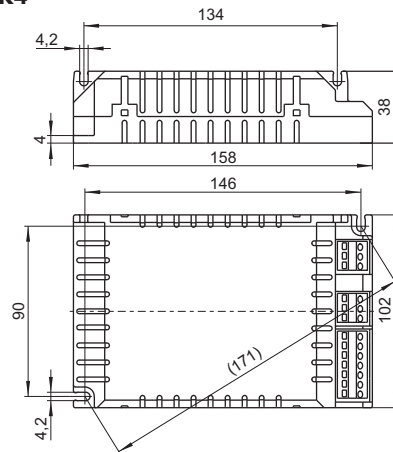

1

2

3

4

5

6

7

8

9

10

ELXc – Warm Start for Compact Fluorescent Lamps



Independent electronic ballasts

K2 mit Zugentlastung

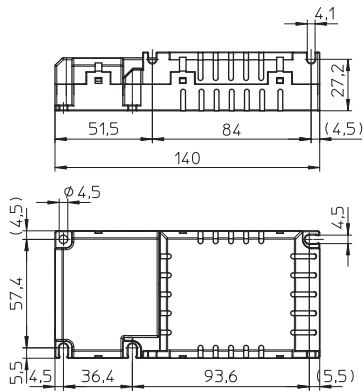

K2.1 with cord grip

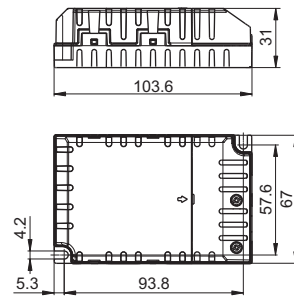

K3 mit Zugentlastung

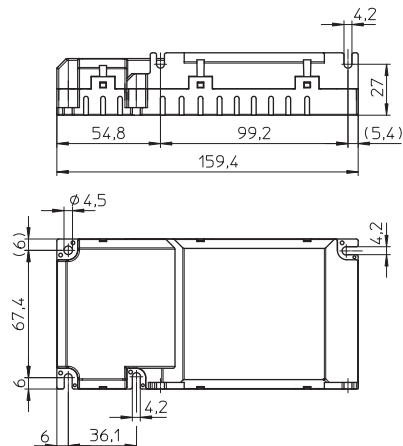

K4 with cord grip

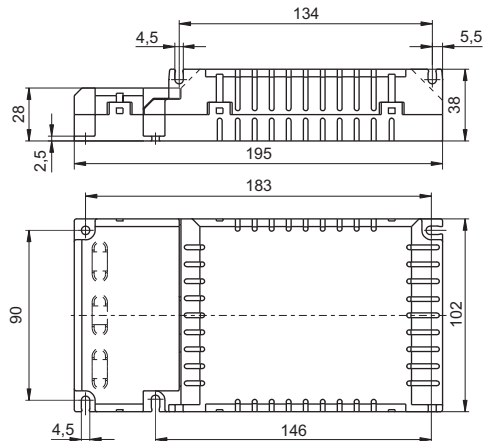

Electronic Ballasts for TC and T Lamps

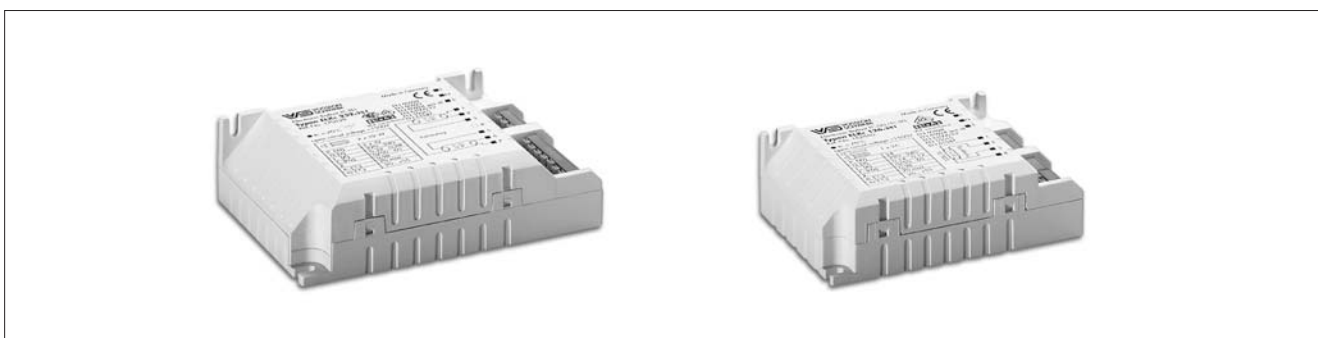

ELXc – Warm start for compact fluorescent lamps

Built-in ballasts

ELXc 213.870, 218.871, 142.872,
242.837, 155.378 have a second earth terminal
to ground the luminaires for example

- T5 TC BUILT-IN 1-10 V
 T8 INDEPENDENT DALI/PUSH

Lamp				Electronic ballast							System	
Output W	Type	Base	Power consumption W	Type	Ref. No.	Voltage AC 50, 60 Hz V±10%	Energie efficiency	Ambient temperature t _a (°C)	Casing temperature t _c (°C)	Casing	Output W	Luminous factor %
9	TC-SEL	2G7	1 x 8.0	ELXc 213.870	188698	220-240	A2 BAT	-20 to 50	max. 65	K2	10.7	102.9
2x9	TC-SEL	2G7	2 x 8.0	ELXc 213.870	188698	220-240	A2 BAT	-20 to 50	max. 65	K2	19.4	102.9
10	TC-DEL	G24q-1	1 x 9.5	ELXc 213.870	188698	220-240	A2 BAT	-20 to 50	max. 65	K2	10.9	99.2
2x10	TC-DEL	G24q-1	2 x 9.5	ELXc 213.870	188698	220-240	A2 BAT	-20 to 50	max. 65	K2	20.5	98.8
11	TC-SEL	2G7	1 x 11.0	ELXc 213.870	188698	220-240	A2 BAT	-20 to 50	max. 65	K2	14.7	110.1
2x11	TC-SEL	2G7	2 x 11.0	ELXc 213.870	188698	220-240	A2 BAT	-20 to 50	max. 65	K2	27.9	116.1
13	TC-DEL/-TEL	G24q-1/GX24q-1	1 x 12.5	ELXc 213.870	188698	220-240	A2 BAT	-20 to 50	max. 65	K2	15.0	102.9
2x13	TC-DEL/-TEL	G24q-1/GX24q-1	2 x 12.5	ELXc 213.870	188698	220-240	A2 BAT	-20 to 50	max. 65	K2	28.1	110.9
18	TC-DEL/-TEL	G24q-2/GX24q-2	1 x 16.5	ELXc 218.871	188699	220-240	A2 BAT	-20 to 50	max. 65	K2	21.0	104.8
	TC-F/-L	2G10/2G11	1 x 16.0	ELXc 142.872	188700	220-240	A2 BAT	-20 to 50	max. 65	K2	18.0	102.0
2x18	TC-DEL/-TEL	G24q-2/GX24q-2	2 x 16.5	ELXc 218.871	188699	220-240	A2 BAT	-20 to 50	max. 65	K2	38.0	100.7
	TC-F/-L	2G10/2G11	2 x 16.0	ELXc 242.837	188643	220-240	A2 BAT	-20 to 50	max. 65	K3	35.0	104.3
				ELXc 142.872	188700	220-240	A2 BAT	-20 to 50	max. 65	K2	34.0	98.0
22	T-R5	2GX13	1 x 22.0	ELXc 142.872	188700	220-240	A2 BAT	-20 to 50	max. 65	K2	26.0	103.0
				ELXc 128.869	188589	220-240	A2 BAT	-20 to 50	max. 70	K2	25.0	96.7
22+40	T-R5	2GX13	1 x 22+40	ELXc 242.837	188643	220-240	A2 BAT	-20 to 50	max. 65	K3	68.0	100.0
2x22	T-R5	2GX13	2 x 22.0	ELXc 242.837	188643	220-240	A2 BAT	-20 to 50	max. 65	K3	48.5	105.8
24	TC-F/-L	2G10/2G11	1 x 22.0	ELXc 142.872	188700	220-240	A2 BAT	-20 to 50	max. 65	K2	27.0	105.0
			1 x 22.5	ELXc 128.869	188589	220-240	A2	-20 to 50	max. 70	K2	25.0	95.8
2x24	TC-F/-L	2G10/2G11	2 x 22.0	ELXc 242.837	188643	220-240	A2 BAT	-20 to 50	max. 65	K3	48.5	106.2
				ELXc 142.872	188700	220-240	A2 BAT	-20 to 50	max. 65	K2	47.0	102.0
26	TC-DEL/-TEL	G24q-3/GX24q-3	1 x 24.0	ELXc 142.872	188700	220-240	A2 BAT	-20 to 50	max. 65	K2	26.0	104.0
2x26	TC-DEL/-TEL	G24q-3/GX24q-3	2 x 24.0	ELXc 242.837	188643	220-240	A2 BAT	-20 to 50	max. 65	K3	53.0	106.1
				ELXc 142.872	188700	220-240	A2 BAT	-20 to 50	max. 65	K2	53.0	105.0

Circuit diagrams see pages 238-241

Electronic Ballasts for TC and T Lamps

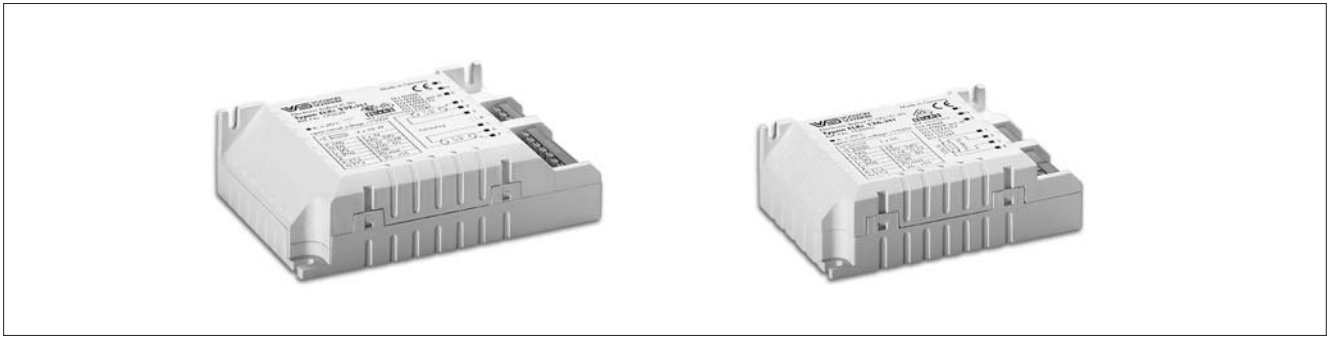

ELXc – Warm start for compact fluorescent lamps

Built-in ballasts

ELXc 213.870, 218.871, 142.872, 242.837, 155.378 have a second earth terminal to ground the luminaires for example

T5 TC BUILT-IN 1-10 V
 T8 INDEPENDENT DALI/PUSH

Lamp				Electronic ballast							System	
Output W	Type	Base	Power consumption W	Type	Ref. No.	Voltage AC 50, 60 Hz V±10%	Energie efficiency	Ambient temperature t _a (°C)	Casing temperature t _c (°C)	Casing	Output W	Luminous factor %
28	TC-DD	GR10q	1 x 26.0	ELXc 128.869	188589	220-240	A2 BAT	-20 to 50	max. 70	K2	32.0	98.1
32	TC-TEL	GX24q-3	1 x 32.0	ELXc 142.872	188700	220-240	A2 BAT	-20 to 50	max. 65	K2	33.0	102.0
2x32	TC-TEL	GX24q-3	2 x 32.0	ELXc 242.837	188643	220-240	A2 BAT	-20 to 50	max. 65	K3	70.5	104.8
36	TC-F/L	2G10/2G11	1 x 32.0	ELXc 142.872	188700	220-240	A2 BAT	-20 to 50	max. 65	K2	34.0	105.0
2x36	TC-F/L	2G10/2G11	2 x 32.0	ELXc 242.837	188643	220-240	A2 BAT	-20 to 50	max. 65	K3	70.5	101.8
38	TC-DD	GR10q	1 x 36.0	ELXc 142.872	188700	220-240	A2 BAT	-20 to 50	max. 65	K2	38.0	95.0
2x38	TC-DD	GR10q	2 x 36.0	ELXc 242.837	188643	220-240	A2 BAT	-20 to 50	max. 65	K3	79.2	101.3
40	TC-L	2G11	1 x 40.0	ELXc 142.872	188700	220-240	A2 BAT	-20 to 50	max. 65	K2	43.0	99.0
	T-R5	2GX13	1 x 40.0	ELXc 142.872	188700	220-240	A2 BAT	-20 to 50	max. 65	K2	41.0	96.0
2x40	TC-L	2G11	2 x 40.0	ELXc 242.837	188643	220-240	A2 BAT	-20 to 50	max. 65	K3	88.0	101.3
	T-R5	2GX13	2 x 40.0	ELXc 242.837	188643	220-240	A2 BAT	-20 to 50	max. 65	K3	88.0	101.1
42	TC-TEL	GX24q-4	1 x 42.0	ELXc 142.872	188700	220-240	A2 BAT	-20 to 50	max. 65	K2	45.0	99.0
2x42	TC-TEL	GX24q-4	2 x 43.0	ELXc 242.837	188643	220-240	A2 BAT	-20 to 50	max. 65	K3	94.5	100.6
55	TC-L	2G11	1 x 55.6	ELXc 155.378	188680	220-240	A2 BAT	-20 to 50	max. 70	K3	60.0	102.4
	T-R5	2GX13	1 x 55.6	ELXc 155.378	188680	220-240	A2 BAT	-20 to 50	max. 70	K3	60.0	101.2
60	T-R5	2GX13	1 x 60.6	ELXc 155.378	188680	220-240	A2	-20 to 50	max. 70	K3	66.0	109.5
80	TC-L	2G11	1 x 80.5	ELXc 155.378	188680	220-240	A2 BAT	-20 to 50	max. 70	K3	88.0	101.3

Circuit diagrams see pages 238-241

Electronic Ballasts for TC and T Lamps



ELXc – Warm start for compact fluorescent lamps – Independent ballasts

For ELXc 257.836 a

loop-through of the mains supply is possible

ELXc 213.870, 218.871, 142.872,

242.837, 155.378 have a second earth terminal

to ground the luminaires

T5 TC BUILT-IN 1-10 V
 T8 INDEPENDENT DALI/PUSH

Lamp				Electronic ballast							System	
Output W	Type	Base	Power consumption W	Type	Ref. No.	Voltage AC 50, 60 Hz V±10%	Energy efficiency	Ambient temperature t _a [°C]	Casing temperature t _c [°C]	Casing	Output W	Luminous factor %
9	TC-SEL	2G7	1 x 8.0	ELXc 213.870	188712	220-240	A2 BAT	-20 to 50	max. 65	K2	10.7	102.9
2x9	TC-SEL	2G7	2 x 8.0	ELXc 213.870	188712	220-240	A2 BAT	-20 to 50	max. 65	K2	19.4	102.9
10	TC-DEL	G24q-1	1 x 9.5	ELXc 213.870	188712	220-240	A2 BAT	-20 to 50	max. 65	K2	10.9	99.2
2x10	TC-DEL	G24q-1	2 x 9.5	ELXc 213.870	188712	220-240	A2 BAT	-20 to 50	max. 65	K2	20.5	98.8
11	TC-SEL	2G7	1 x 11.0	ELXc 213.870	188712	220-240	A2 BAT	-20 to 50	max. 65	K2	14.7	110.1
2x11	TC-SEL	2G7	2 x 11.0	ELXc 213.870	188712	220-240	A2 BAT	-20 to 50	max. 65	K2	27.9	116.1
13	TC-DEL/-TEL	G24q-1/GX24q-1	1 x 12.5	ELXc 213.870	188712	220-240	A2 BAT	-20 to 50	max. 65	K2	15.0	102.9
2x13	TC-DEL/-TEL	G24q-1/GX24q-1	2 x 12.5	ELXc 213.870	188712	220-240	A2 BAT	-20 to 50	max. 65	K2	28.1	110.9
18	TC-DEL/-TEL	G24q-2/GX24q-2	1 x 16.5	ELXc 218.871	188713	220-240	A2 BAT	-20 to 50	max. 65	K2	21.0	104.8
	TC-F/L	2G10/2G11	1 x 16.0	ELXc 142.872	188714	220-240	A2 BAT	-20 to 50	max. 65	K2	18.0	102.0
2x18	TC-DEL/-TEL	G24q-2/GX24q-2	2 x 16.5	ELXc 218.871	188713	220-240	A2 BAT	-20 to 50	max. 65	K2	38.0	100.7
	TC-F/L	2G10/2G11	2 x 16.0	ELXc 242.837	188687	220-240	A2 BAT	-20 to 50	max. 65	K3	35.0	104.3
				ELXc 142.872	188714	220-240	A2 BAT	-20 to 50	max. 65	K2	34.0	98.0
22	T-R5	2GX13	1 x 22.0	ELXc 142.872	188714	220-240	A2 BAT	-20 to 50	max. 65	K2	26.0	103.0
				ELXc 128.869	188590	220-240	A2 BAT	-20 to 50	max. 70	K2	25.0	96.7
22+40	T-R5	2GX13	1 x 22+40	ELXc 242.837	188687	220-240	A2 BAT	-20 to 50	max. 65	K3	68.0	100.0
2x22	T-R5	2GX13	2 x 22.0	ELXc 242.837	188687	220-240	A2 BAT	-20 to 50	max. 65	K3	48.5	105.8
24	TC-F/L	2G10/2G11	1 x 22.0	ELXc 142.872	188714	220-240	A2 BAT	-20 to 50	max. 65	K2	27.0	105.0
	TC-F/L	2G10/2G11	1 x 22.5	ELXc 128.869	188590	220-240	A2	-20 to 50	max. 70	K2	25.0	95.8
2x24	TC-F/L	2G10/2G11	2 x 22.0	ELXc 242.837	188687	220-240	A2 BAT	-20 to 50	max. 65	K3	48.5	106.2
				ELXc 142.872	188714	220-240	A2 BAT	-20 to 50	max. 65	K2	47.0	102.0
26	TC-DEL/-TEL	G24q-3/GX24q-3	1 x 24.0	ELXc 142.872	188714	220-240	A2 BAT	-20 to 50	max. 65	K2	26.0	104.0
				ELXc 226.878	183040	220-240	A2 BAT	-20 to 55	max. 65	K2.1	28.0	104.0
				ELXc 226.878	183108*	220-240	A2 BAT	-20 to 55	max. 65	K2.1	28.0	104.0
2x26	TC-DEL/-TEL	G24q-3/GX24q-3	2 x 24.0	ELXc 226.878	183040	220-240	A2 BAT	-20 to 55	max. 65	K2.1	50.0	101.0
				ELXc 226.878	183108*	220-240	A2 BAT	-20 to 55	max. 65	K2.1	50.0	101.0
				ELXc 242.837	188687	220-240	A2 BAT	-20 to 50	max. 65	K3	53.0	106.1
				ELXc 257.836	188400	220-240	A2 BAT	-20 to 50	max. 70	K4	52.0	106.2
				ELXc 142.872	188714	220-240	A2 BAT	-20 to 50	max. 65	K2	53.0	105.0

Circuit diagrams see pages 238-241

* Without cover cap on cord grip = built-in version

Electronic Ballasts for TC and T Lamps

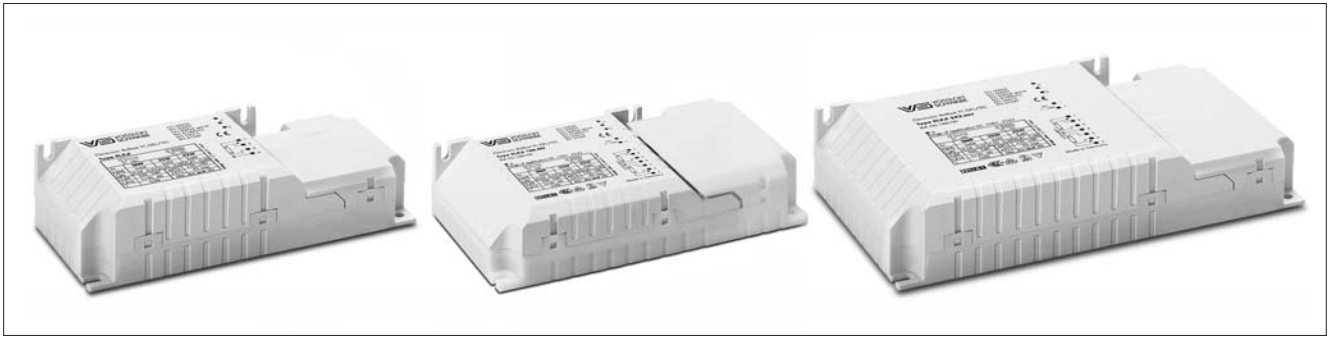

ELXc – Compact warm start for compact fluorescent lamps – Independent ballasts

For ELXc 257.836 a

loop-through of the mains supply is possible

ELXc 213.870, 218.871, 142.872,

242.837, 155.378 have a second earth terminal

to ground the luminaires for example

<input type="radio"/> T5	<input checked="" type="radio"/> TC	<input type="radio"/> BUILT-IN	<input type="radio"/> 1-10 V
<input type="radio"/> T8	<input checked="" type="radio"/> INDEPENDENT	<input type="radio"/> DALI/PUSH	

Lamp				Electronic ballast							System	
Output W	Type	Base	Power consumption W	Type	Ref. No.	Voltage AC 50, 60 Hz V±10%	Energy efficiency	Ambient temperature t _a (°C)	Casing temperature t _c (°C)	Casing	Output W	Luminous factor %
28	TC-DD	GR10q	1 x 26.0	ELXc 128.869	188590	220-240	A2 BAT	-20 to 50	max. 70	K2	32.0	98.1
32	TC-TEL	GX24q-3	1 x 32.0	ELXc 142.872	188714	220-240	A2 BAT	-20 to 50	max. 65	K2	33.0	102.0
2x32	TC-TEL	GX24q-3	2 x 32.0	ELXc 242.837	188687	220-240	A2 BAT	-20 to 50	max. 65	K3	70.5	104.8
				ELXc 257.836	188400	220-240	A2 BAT	-20 to 50	max. 70	K4	70.0	109.4
36	TC-F/L	2G10/2G11	1 x 32.0	ELXc 142.872	188714	220-240	A2 BAT	-20 to 50	max. 65	K2	34.0	105.0
2x36	TC-F/L	2G10/2G11	2 x 32.0	ELXc 242.837	188687	220-240	A2 BAT	-20 to 50	max. 65	K3	70.5	101.8
38	TC-DD	GR10q	1 x 36.0	ELXc 142.872	188714	220-240	A2 BAT	-20 to 50	max. 65	K2	38.0	95.0
2x38	TC-DD	GR10q	2 x 36.0	ELXc 242.837	188687	220-240	A2 BAT	-20 to 50	max. 65	K3	79.2	101.3
40	TC-L	2G11	1 x 40.0	ELXc 142.872	188714	220-240	A2 BAT	-20 to 50	max. 65	K2	43.0	99.0
	T-R5	2GX13	1 x 40.0	ELXc 142.872	188714	220-240	A2 BAT	-20 to 50	max. 65	K2	41.0	96.0
2x40	TC-L	2G11	2 x 40.0	ELXc 242.837	188687	220-240	A2 BAT	-20 to 50	max. 65	K3	88.0	101.3
	T-R5	2GX13	2 x 40.0	ELXc 242.837	188687	220-240	A2 BAT	-20 to 50	max. 65	K3	88.0	101.1
42	TC-TEL	GX24q-4	1 x 42.0	ELXc 142.872	188714	220-240	A2 BAT	-20 to 50	max. 65	K2	45.0	99.0
2x42	TC-TEL	GX24q-4	2 x 43.0	ELXc 242.837	188687	220-240	A2 BAT	-20 to 50	max. 65	K3	94.5	100.6
				ELXc 257.836	188400	220-240	A2 BAT	-20 to 50	max. 70	K4	94.0	104.9
55	TC-L	2G11	1 x 55.6	ELXc 155.378	188681	220-240	A2 BAT	-20 to 50	max. 70	K3	60.0	102.4
	T-R5	2GX13	1 x 55.6	ELXc 155.378	188681	220-240	A2 BAT	-20 to 50	max. 70	K3	60.0	101.2
60	T-R5	2GX13	1 x 60.6	ELXc 155.378	188681	220-240	A2	-20 to 50	max. 70	K3	66.0	109.5
80	TC-L	2G11	1 x 80.5	ELXc 155.378	188681	220-240	A2 BAT	-20 to 50	max. 70	K3	88.0	101.3

Circuit diagrams see pages 238-241

ELXc – ECO EffectLine Warm Start for Compact Fluorescent Lamps

Electronic ballasts

Casing: PC, white

Mains voltage: 198-264 V

Push-in terminals: 0,5-1,5 mm²

RFI-suppressed

For luminaires of protection class I

Degree of protection: IP20

For lighting systems with

high switching frequency (> 5/day)

EOL shut down approved acc. to EN 61347 Test 1



K1.1

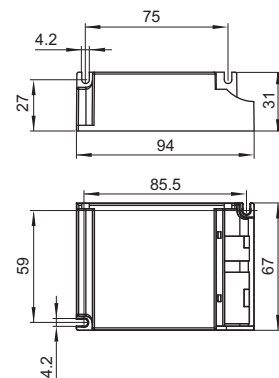

ELXc – Warm start for compact fluorescent lamps – Built-in ballasts

- T5 TC BUILT-IN 1-10 V
 T8 INDEPENDENT DALI/PUSH

Lamp				Electronic ballast								System	
Output W	Type	Base	Power consumption W	Type	Ref. No.	Voltage AC 50, 60 Hz V±10 %	Energy efficiency	Power factor	Ambient temperature t _a (°C)	Casing temperature t _c (°C)	Output W	Luminous factor %	
18	TC-DEL/TEL	G24q-2/GX24q-2	1 x 16.5	ELXc 118.879	183134	220-240	A2	> 0.95	-10 to 50	max. 70	19.5	100	
2x18	TC-DEL/TEL	G24q-2/GX24q-2	2 x 16.5	ELXc 218.881	183136	220-240	A2	> 0.95	-15 to 50	max. 75	38.0	100	
26	TC-DEL/TEL	G24q-3/GX24q-3	1 x 24.0	ELXc 126.880	183135	220-240	A2	> 0.95	-10 to 50	max. 75	28.0	100	
2x26	TC-DEL/TEL	G24q-3/GX24q-3	2 x 24.0	ELXc 226.882	183137	220-240	A2	> 0.95	-15 to 50	max. 80	53.5	100	

Preliminary data | Circuit diagrams see pages 238-241

ELXc – Warm Start for Compact Fluorescent Lamps

Independent electronic ballasts
 Casing: heat-resistant polyamide (K3)
 Power factor: > 0.96
 DC voltage
 for operation: 176–264 V
 for ignition: 198–264 V

Push-in terminals with lever opener: 0.5–1.5 mm²

Mains and earth through-wiring on primary side is possible

Existing terminals: 2xL; 2xN; 3xPE

RFI-suppressed

Constant power consumption

For luminaires of protection class I

Degree of protection: IP20

Fixing brackets for screws M4

for lateral or base mounting

For lighting systems with high switching frequency (> 5/day)

EOL shut down approved acc. to EN 61347 Test 2

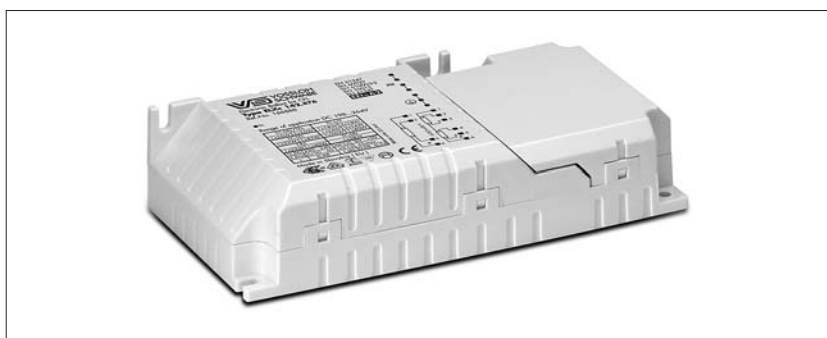

K3 with cord grip

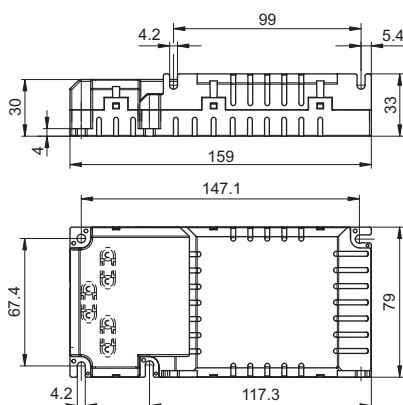

- T5 TC BUILT-IN 1–10 V
- T8 INDEPENDENT DALI/PUSH

Lamp				Electronic ballast							System	
Output W	Type	Base	Power consumption W	Type	Ref. No.	Voltage AC 50, 60 Hz V±10%	Energy efficiency	Ambient temperature t _a (°C)	Casing temperature t _c (°C)	Casing	Output W	Luminous factor %
9	TC-SEL	2G7	1 x 8.0	ELXc 213.874	188886	220–240	A2 BAT	-20 to 50	max. 65	K3	10.7	102.9
2x9	TC-SEL	2G7	2 x 8.0	ELXc 213.874	188886	220–240	A2 BAT	-20 to 50	max. 65	K3	19.4	102.9
10	TC-DEL	G24q-1	1 x 9.5	ELXc 213.874	188886	220–240	A2 BAT	-20 to 50	max. 65	K3	10.9	99.2
2x10	TC-DEL	G24q-1	2 x 9.5	ELXc 213.874	188886	220–240	A2 BAT	-20 to 50	max. 65	K3	20.5	98.8
11	TC-SEL	2G7	1 x 11.0	ELXc 213.874	188886	220–240	A2 BAT	-20 to 50	max. 65	K3	14.7	110.1
2x11	TC-SEL	2G7	2 x 11.0	ELXc 213.874	188886	220–240	A2 BAT	-20 to 50	max. 65	K3	27.9	116.1
13	TC-DEL/TEL	G24q-1/GX24q-1	1 x 12.5	ELXc 213.874	188886	220–240	A2 BAT	-20 to 50	max. 65	K3	15.0	102.9
2x13	TC-DEL/TEL	G24q-1/GX24q-1	2 x 12.5	ELXc 213.874	188886	220–240	A2 BAT	-20 to 50	max. 65	K3	28.1	110.9
18	TC-DEL/TEL	G24q-2/GX24q-2	1 x 16.5	ELXc 218.875	188887	220–240	A2 BAT	-20 to 50	max. 65	K3	21.0	104.8
	TC-F/L	2G10/2G11	1 x 16.0	ELXc 142.876	188888	220–240	A2 BAT	-20 to 50	max. 65	K3	18.0	102.0
2x18	TC-DEL/TEL	G24q-2/GX24q-2	2 x 16.5	ELXc 218.875	188887	220–240	A2 BAT	-20 to 50	max. 65	K3	38.0	100.7
	TC-F/L	2G10/2G11	2 x 16.0	ELXc 242.877	188889	220–240	A2	-20 to 50	max. 65	K3	35.0	104.3
				ELXc 142.876	188888	220–240	A2 BAT	-20 to 50	max. 65	K3	34.0	98.0
22	T-R5	2GX13	1 x 22.0	ELXc 142.876	188888	220–240	A2 BAT	-20 to 50	max. 65	K3	26.0	103.0
22+40	T-R5	2GX13	1 x 22+40	ELXc 242.877	188889	220–240	A2	-20 to 50	max. 65	K3	68.0	100.0
2x22	T-R5	2GX13	2 x 22.0	ELXc 242.877	188889	220–240	A2	-20 to 50	max. 65	K3	48.5	105.8
24	TC-F/L	2G10/2G11	1 x 22.0	ELXc 142.876	188888	220–240	A2 BAT	-20 to 50	max. 65	K3	27.0	105.0
2x24	TC-F/L	2G10/2G11	2 x 22.0	ELXc 242.877	188889	220–240	A2 BAT	-20 to 50	max. 65	K3	48.5	106.2
				ELXc 142.876	188888	220–240	A2 BAT	-20 to 50	max. 65	K3	47.0	102.0

Circuit diagrams see pages 238–241

ELXc – Warm Start for Compact Fluorescent Lamps

ELXc – Warm start for compact fluorescent lamps – Independent ballasts

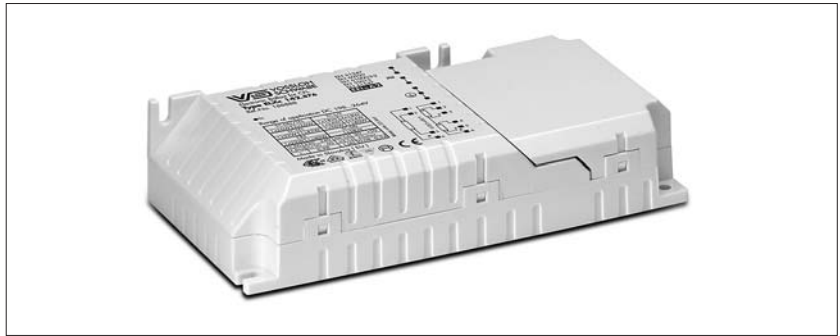

- T5
- TC
- BUILT-IN
- 1-10 V
- T8
- INDEPENDENT
- DALI/PUSH

Lamp				Electronic ballast							System	
Output W	Type	Base	Power consumption W	Type	Ref. No.	Voltage AC 50, 60 Hz V±10%	Energy efficiency	Ambient temperature t _a (°C)	Casing temperature t _c (°C)	Casing	Output W	Luminous factor %
26	TC-DEL/-TEL	G24q-3/GX24q-3	1 x 24.0	ELXc 142.876	188888	220-240	A2 BAT	-20 to 50	max. 65	K3	26.0	104.0
2x26	TC-DEL/-TEL	G24q-3/GX24q-3	2 x 24.0	ELXc 242.877	188889	220-240	A2 BAT	-20 to 50	max. 65	K3	53.0	106.1
				ELXc 142.876	188888	220-240	A2 BAT	-20 to 50	max. 65	K3	53.0	105.0
32	TC-TEL	GX24q-3	1 x 32.0	ELXc 142.876	188888	220-240	A2 BAT	-20 to 50	max. 65	K3	33.0	102.0
2x32	TC-TEL	GX24q-3	2 x 32.0	ELXc 242.877	188889	220-240	A2 BAT	-20 to 50	max. 65	K3	70.5	104.8
36	TC-F/-L	2G10/2G11	1 x 32.0	ELXc 142.876	188888	220-240	A2 BAT	-20 to 50	max. 65	K3	34.0	105.0
2x36	TC-F/-L	2G10/2G11	2 x 32.0	ELXc 242.877	188889	220-240	A2 BAT	-20 to 50	max. 65	K3	70.5	101.8
38	TC-DD	GR10q	1 x 36.0	ELXc 142.876	188888	220-240	A2 BAT	-20 to 50	max. 65	K3	38.0	95.0
2x38	TC-DD	GR10q	2 x 36.0	ELXc 242.877	188889	220-240	A2 BAT	-20 to 50	max. 65	K3	79.2	101.3
40	TC-L	2G11	1 x 40.0	ELXc 142.876	188888	220-240	A2 BAT	-20 to 50	max. 65	K3	43.0	99.0
	T-R5	2GX13	1 x 40.0	ELXc 142.876	188888	220-240	A2 BAT	-20 to 50	max. 65	K3	41.0	96.0
2x40	TC-L	2G11	2 x 40.0	ELXc 242.877	188889	220-240	A2	-20 to 50	max. 65	K3	88.0	101.3
	T-R5	2GX13	2 x 40.0	ELXc 242.877	188889	220-240	A2	-20 to 50	max. 65	K3	88.0	101.1
42	TC-TEL	GX24q-4	1 x 42.0	ELXc 142.876	188888	220-240	A2 BAT	-20 to 50	max. 65	K3	45.0	99.0
2x42	TC-TEL	GX24q-4	2 x 43.0	ELXc 242.877	188889	220-240	A2 BAT	-20 to 50	max. 65	K3	94.5	100.6

Circuit diagrams see pages 238-241

- 1
- 2
- 3
- 4
- 5
- 6
- 7
- 8
- 9
- 10

ELXd – Dimmable for TC-DEL, TC-TEL Lamps

Electronic ballasts

Casing: heat-resistant polycarbonate

Dimming range:

approx. 3–100% of lamp power

Push-in terminals with lever opener: 0.5–1.5 mm²

RFI-suppressed

Degree of protection: IP20

For luminaires of protection class I

Fixing brackets for screws M4

for lateral or base mounting

For lighting systems with

high switching frequency (> 5/day)

EOL shut down approved

acc. to EN 61347 Test 2



Electronic built-in ballasts

K2

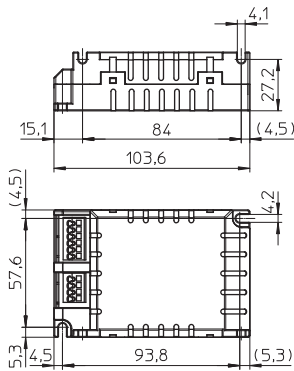

K3

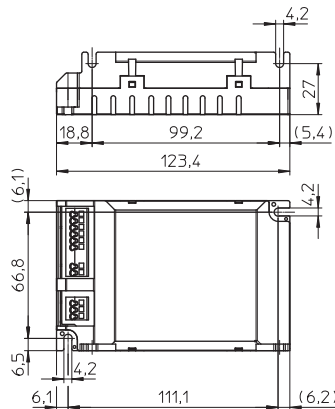

K4

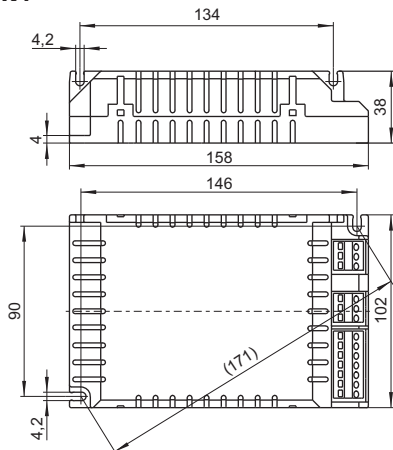

K4+ with venting slits

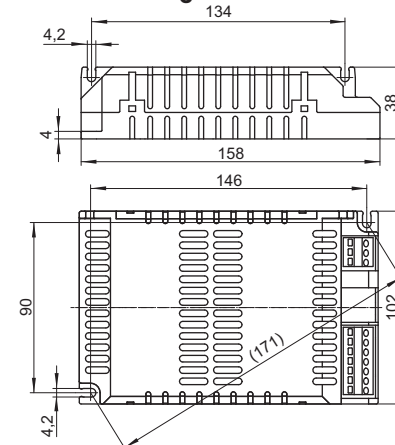

ELXd – Dimmable for TC-DEL, TC-TEL Lamps

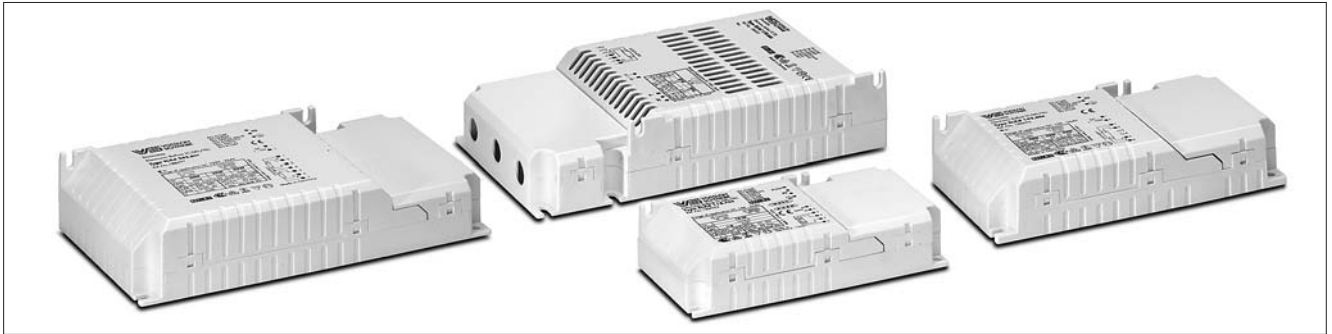

Independent electronic ballasts

K2 with cord grip

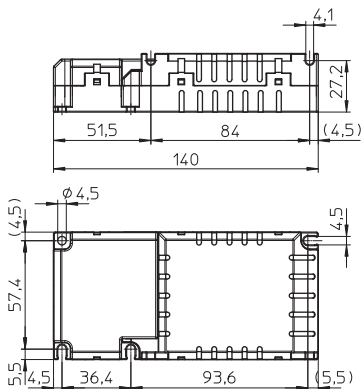

K3 with cord grip

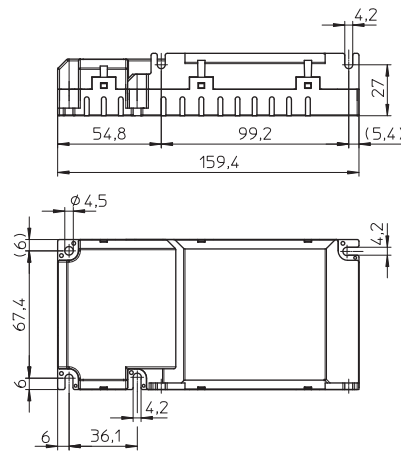

K4 with cord grip

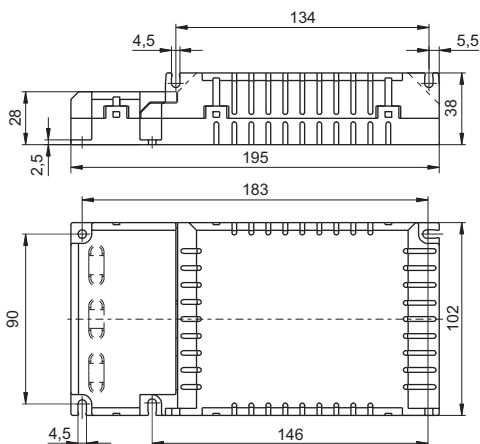

K4+ with cord grip and venting slits

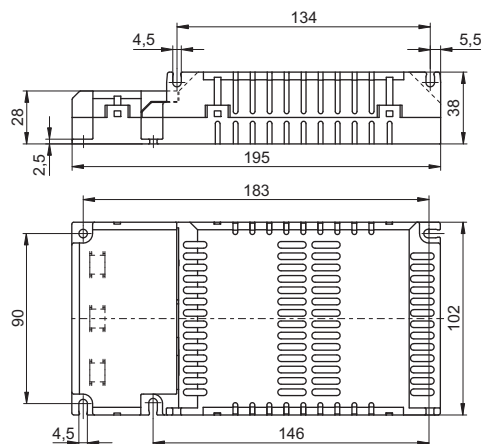

Electronic Ballasts for TC and T Lamps

ELXd – Dimmable 1–10 V for TC-DEL, TC-TEL lamps

Electronic built-in ballasts

Casing: K3, K4 and K4+ with venting slits

Control voltage: DC 1–10 V acc. to

EN 60929 with earth leakage current 0.5 mA
(protected if connected to mains voltage)

For use with open- or closed-loop control units

Power factor: 0.98 at 100% operation

DC voltage

for operation: 176–264 V

for ignition: 198–264 V

- T5 TC BUILT-IN 1–10 V
 T8 INDEPENDENT DALI/PUSH

Lamp				Electronic ballast							System	
Output W	Type	Base	Power consumption W	Type	Ref. No.	Voltage AC 50, 60 Hz V±10%	Energy efficiency	Ambient temperature t _a (°C)	Casing temperature t _c (°C)	Casing	Output W	Luminous factor %
18	TC-DEL/-TEL	G24q-2/GX24q-2	1 x 16.5	ELXd 118.802	188564	220–240	A1 BAT	5 to 55	max. 70	K3	21.0	100.0
2x18	TC-DEL/-TEL	G24q-2/GX24q-2	2 x 16.5	ELXd 218.803	188549	220–240	A1 BAT	5 to 55	max. 70	K4	38.0	100.0
26	TC-DEL/-TEL	G24q-3/GX24q-3	1 x 24.0	ELXd 142.806	188565	220–240	A1 BAT	10 to 50	max. 70	K3	27.0	100.0
2x26	TC-DEL/-TEL	G24q-3/GX24q-3	2 x 24.0	ELXd 242.807	188550	220–240	A1 BAT	10 to 50	max. 70	K4	53.0	100.0
				ELXd 226.801	188431	220–240	A1 BAT	10 to 50	max. 70	K3	54.0	100.0
32	TC-TEL	GX24q-3	1 x 32.0	ELXd 142.806	188565	220–240	A1 BAT	10 to 50	max. 70	K3	36.0	100.0
2x32	TC-TEL	GX24q-3	2 x 32.0	ELXd 242.807	188550	220–240	A1 BAT	10 to 50	max. 70	K4	71.0	100.0
42	TC-TEL	GX24q-4	1 x 43.0	ELXd 142.806	188565	220–240	A1 BAT	10 to 50	max. 70	K3	46.0	100.0
2x42	TC-TEL	GX24q-4	2 x 43.0	ELXd 242.807	188550	220–240	A1 BAT	10 to 50	max. 70	K4	92.0	100.0

Circuit diagrams see pages 238–241

ELXd – Dimmable 1–10 V for TC-DEL, TC-TEL lamps

Independent electronic ballasts

Casing with cord grip: K3, K4 and

K4+ with venting slits

Control voltage: DC 1–10 V acc. to

EN 60929 with earth leakage current 0.5 mA
(protected if connected to mains voltage)

For use with open- or closed-loop control units

Power factor: 0.98 at 100% operation

DC voltage

for operation: 176–264 V

for ignition: 198–264 V

- T5 TC BUILT-IN 1–10 V
 T8 INDEPENDENT DALI/PUSH

Lamp				Electronic ballast							System	
Output W	Type	Base	Power consumption W	Type	Ref. No.	Voltage AC 50, 60 Hz V±10%	Energy efficiency	Ambient temperature t _a (°C)	Casing temperature t _c (°C)	Casing	Output W	Luminous factor %
18	TC-DEL/-TEL	G24q-2/GX24q-2	1 x 16.5	ELXd 118.802	188694	220–240	A1 BAT	5 to 55	max. 70	K3	21.0	100.0
2x18	TC-DEL/-TEL	G24q-2/GX24q-2	2 x 16.5	ELXd 218.803	188696	220–240	A1 BAT	5 to 55	max. 70	K4	38.0	100.0
26	TC-DEL/-TEL	G24q-3/GX24q-3	1 x 24.0	ELXd 142.806	188695	220–240	A1 BAT	10 to 50	max. 70	K3	27.0	100.0
2x26	TC-DEL/-TEL	G24q-3/GX24q-3	2 x 24.0	ELXd 242.807	188697	220–240	A1 BAT	10 to 50	max. 70	K4	53.0	100.0
				ELXd 226.801	188490	220–240	A1 BAT	10 to 50	max. 70	K3	54.0	100.0
32	TC-TEL	GX24q-3	1 x 32.0	ELXd 142.806	188695	220–240	A1 BAT	10 to 50	max. 70	K3	36.0	100.0
2x32	TC-TEL	GX24q-3	2 x 32.0	ELXd 242.807	188697	220–240	A1 BAT	10 to 50	max. 70	K4	71.0	100.0
42	TC-TEL	GX24q-4	1 x 43.0	ELXd 142.806	188695	220–240	A1 BAT	10 to 50	max. 70	K3	46.0	100.0
2x42	TC-TEL	GX24q-4	2 x 43.0	ELXd 242.807	188697	220–240	A1 BAT	10 to 50	max. 70	K4	92.0	100.0

Circuit diagrams see pages 238–241

Electronic Ballasts for TC and T Lamps

ELXd – Dimmable with push key or DALI for TC-DEL, TC-TEL lamps

Electronic ballasts

PUSH: dimmable with usual push key and sensor

DALI: poles are not polarity sensitive (protected if connected to mains voltage) for use with DALI compatible control units

Automatic restart after lamp has been changed

Power factor: > 0.95 at 100% operation

DC voltage

for operation: 176-264 V

for ignition: 198-264 V

Standby power consumption: ≤ 0.5 W

Complete implementation of the DALI-standard:

addressable, memory store for scenes and groups, revertive information communication, physical and

RND-selection, standardized lamp characteristic

Low-power design ensures very low standby

power consumption

Compatible with IEC 62386

Electronic built-in ballasts

T5 TC BUILT-IN 1-10 V
 T8 INDEPENDENT DALI/PUSH

Lamp				Electronic ballast							System	
Output W	Type	Base	Power consumption W	Type	Ref. No.	Voltage AC 50, 60 Hz V±10%	Energy efficiency	Ambient temperature t _a (°C)	Casing temperature t _c (°C)	Casing	Output W	Luminous factor %
14	TC-TEL	GR14q-1	1 x 16.7	ELXd 117.715	188864	220-240	A1 BAT	10 to 50	max. 65	K2	18.0	103.8
2x14	TC-TEL	GR14q-1	2 x 14.0	ELXd 217.717	188866	220-240	A1 BAT	10 to 60	max. 70	K3	33.8	95.9
17	TC-TEL	GR14q-1	1 x 20.0	ELXd 117.715	188864	220-240	A1 BAT	10 to 50	max. 65	K2	22.0	105.3
2x17	TC-TEL	GR14q-1	2 x 17.0	ELXd 217.717	188866	220-240	A1 BAT	10 to 60	max. 70	K3	40.7	95.2
18	TC-DEL/TEL	G24q-2/GX24q-2	1 x 16.5	ELXd 118.705	188952	220-240	A1 BAT	10 to 50	max. 65	K2	20.2	105.5
2x18	TC-DEL/TEL	G24q-2/GX24q-2	2 x 18.0	ELXd 218.707	188954	220-240	A1 BAT	10 to 50	max. 70	K3	40.0	100.1
26	TC-DEL/TEL	G24q-3/GX24q-3	1 x 25.0	ELXd 142.709	188923	220-240	A1 BAT	10 to 50	max. 65	K2	27.5	106.8
2x26	TC-DEL/TEL	G24q-3/GX24q-3	2 x 24.0	ELXd 242.711	188974	220-240	A1 BAT	10 to 50	max. 70	K3	56.0	97.9
32	TC-TEL	GX24q-3	1 x 32.0	ELXd 142.709	188923	220-240	A1 BAT	10 to 50	max. 65	K2	34.5	106.3
2x32	TC-TEL	GX24q-3	2 x 32.0	ELXd 242.711	188974	220-240	A1 BAT	10 to 50	max. 70	K3	69.0	97.6
42	TC-TEL	GX24q-4	1 x 42.0	ELXd 142.709	188923	220-240	A1 BAT	10 to 50	max. 65	K2	45.0	103.8
2x42	TC-TEL	GX24q-4	2 x 42.0	ELXd 242.711	188974	220-240	A1 BAT	10 to 50	max. 70	K3	90.0	99.1

Circuit diagrams see pages 238-241

Independent electronic ballasts

T5 TC BUILT-IN 1-10 V
 T8 INDEPENDENT DALI/PUSH

Lamp				Electronic ballast							System	
Output W	Type	Base	Power consumption W	Type	Ref. No.	Voltage AC 50, 60 Hz V±10%	Energy efficiency	Ambient temperature t _a (°C)	Casing temperature t _c (°C)	Casing	Output W	Luminous factor %
14	TC-TEL	GR14q-1	1 x 16.7	ELXd 117.715	188865	220-240	A1 BAT	10 to 50	max. 65	K2	18.0	103.8
2x14	TC-TEL	GR14q-1	2 x 14.0	ELXd 217.717	188867	220-240	A1 BAT	10 to 60	max. 70	K3	33.8	95.9
17	TC-TEL	GR14q-1	1 x 20.0	ELXd 117.715	188865	220-240	A1 BAT	10 to 50	max. 65	K2	22.0	105.3
2x17	TC-TEL	GR14q-1	2 x 17.0	ELXd 217.717	188867	220-240	A1 BAT	10 to 60	max. 70	K3	40.7	95.2
18	TC-DEL/TEL	G24q-2/GX24q-2	1 x 16.5	ELXd 118.705	188953	220-240	A1 BAT	10 to 50	max. 65	K2	20.2	105.5
2x18	TC-DEL/TEL	G24q-2/GX24q-2	2 x 18.0	ELXd 218.707	188955	220-240	A1 BAT	10 to 60	max. 70	K3	40.0	100.1
26	TC-DEL/TEL	G24q-3/GX24q-3	1 x 25.0	ELXd 142.709	188924	220-240	A1 BAT	10 to 50	max. 65	K2	27.5	106.3
2x26	TC-DEL/TEL	G24q-3/GX24q-3	2 x 24.0	ELXd 242.711	188975	220-240	A1 BAT	10 to 50	max. 70	K3	56.0	97.9
32	TC-TEL	GX24q-3	1 x 32.0	ELXd 142.709	188924	220-240	A1 BAT	10 to 50	max. 65	K2	34.8	106.3
2x32	TC-TEL	GX24q-3	2 x 32.0	ELXd 242.711	188975	220-240	A1 BAT	10 to 50	max. 70	K3	69.0	97.6
42	TC-TEL	GX24q-4	1 x 42.0	ELXd 142.709	188924	220-240	A1 BAT	10 to 50	max. 65	K2	45.0	103.8
2x42	TC-TEL	GX24q-4	2 x 42.0	ELXd 242.711	188975	220-240	A1 BAT	10 to 50	max. 70	K3	90.0	99.1

Circuit diagrams see pages 238-241

ELXc – Warm Start for T5 and T8 Lamps

Electronic built-in ballasts
 Casing: metal
 Power factor: ≥ 0.95
 RFI-suppressed
 For luminaires of protection class I

Degree of protection: IP20
 For lighting systems with
 high switching frequency ($> 5/\text{day}$)

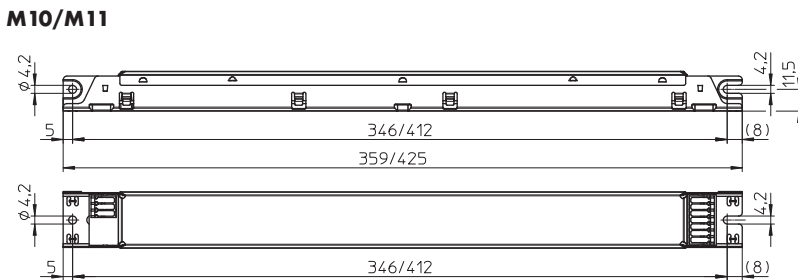
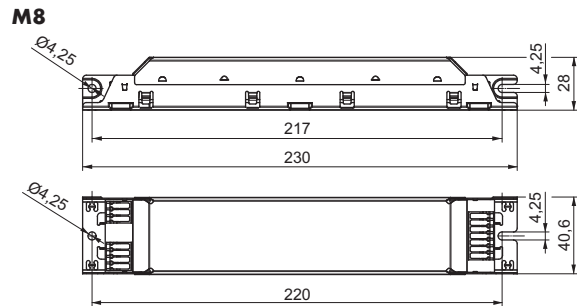
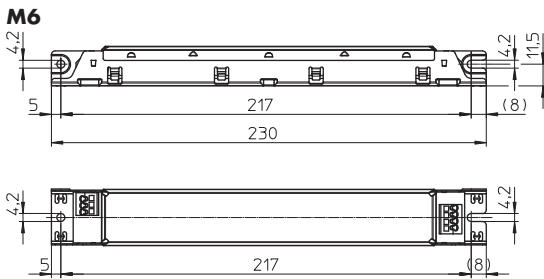
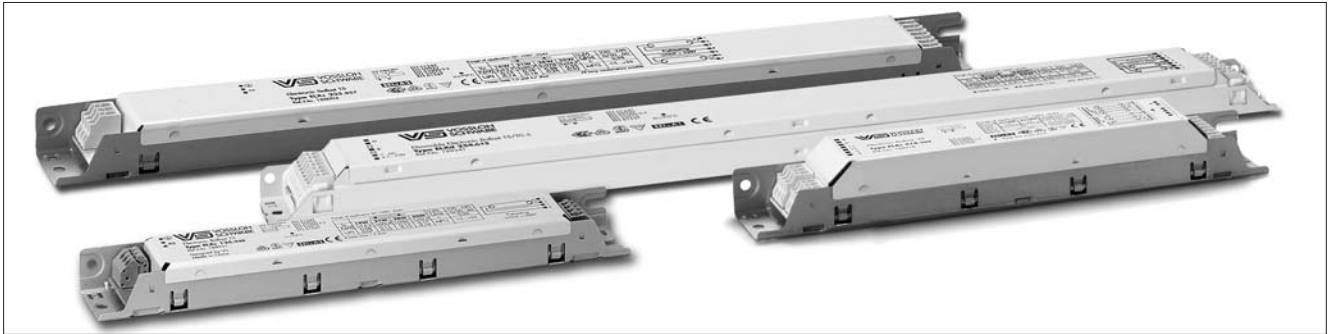

ELXc – Warm Start for T5 and T8 Lamps

DC voltage

for operation: 176-264 V

for ignition: 198-264 V

(ELXc 135.856, 235.857, 149.858, 154.864,
180.866, 270.206; 280.538:

DC voltage cannot be reduced to 176 V)

Push-in terminals: 0.5-1 mm²

For the automatic luminaire wiring:

IDC terminals for leads HO5V-U 0.5

EOL shut down approved

acc. to EN 61347 Test 2 (for T5)

EOL shut down (for T8)

T5 TC BUILT-IN 1-10 V
 T8 INDEPENDENT DALI/PUSH

Lamp				Electronic ballast							System	
Output W	Type	Base	Power consumption W	Type	Ref. No.	Voltage AC 50, 60 Hz V±10%	Energy efficiency	Ambient temperature t _a (°C)	Casing temperature t _c (°C)	Casing	Output W	Luminous factor %
For T5 lamps - Casing: M8, M10 and M11												
14	T5	G5	1 x 14.0	ELXc 135.856	188093	220-240	A2 BAT	-15 to 55	max. 70	M10	17.0	110.7
2x14	T5	G5	2 x 14.0	ELXc 235.857	188094	220-240	A2 BAT	-15 to 55	max. 70	M10	33.4	107.0
3x14	T5	G5	3 x 14.0	ELXc 414.868	188438	220-240	A2 BAT	-15 to 55	max. 70	M8	48.0	105.4
4x14	T5	G5	4 x 14.0	ELXc 414.868	188438	220-240	A2 BAT	-15 to 55	max. 70	M8	63.0	102.3
21	T5	G5	1 x 21.0	ELXc 135.856	188093	220-240	A2 BAT	-15 to 55	max. 70	M10	24.0	107.4
2x21	T5	G5	2 x 21.0	ELXc 235.857	188094	220-240	A2 BAT	-15 to 55	max. 70	M10	50.2	110.6
24	T5	G5	1 x 22.5	ELXc 140.862	188140	220-240	A2 BAT	-15 to 55	max. 70	M10	27.0	114.0
2x24	T5	G5	2 x 22.5	ELXc 240.863	188616	220-240	A2 BAT	-15 to 55	max. 70	M10	51.0	107.4
3x24	T5	G5	3 x 22.5	ELXc 424.223	183039	220-240	A2 BAT	-15 to 55	max. 75	M8	78.0	103.7
4x24	T5	G5	4 x 22.5	ELXc 424.223	183039	220-240	A2 BAT	-15 to 55	max. 75	M8	101.7	103.5
28	T5	G5	1 x 28.0	ELXc 135.856	188093	220-240	A2 BAT	-15 to 55	max. 70	M10	32.0	104.9
2x28	T5	G5	2 x 28.0	ELXc 235.857	188094	220-240	A2 BAT	-15 to 55	max. 70	M10	60.6	106.2
35	T5	G5	1 x 35.0	ELXc 135.856	188093	220-240	A2 BAT	-15 to 55	max. 70	M10	39.5	102.7
2x35	T5	G5	2 x 35.0	ELXc 235.857	188094	220-240	A2 BAT	-15 to 55	max. 70	M10	74.5	102.5
39	T5	G5	1 x 38.0	ELXc 140.862	188140	220-240	A2 BAT	-15 to 55	max. 70	M10	43.0	107.0
2x39	T5	G5	2 x 38.0	ELXc 240.863	188616	220-240	A2 BAT	-15 to 55	max. 70	M10	82.0	97.9
49	T5	G5	1 x 49.0	ELXc 149.858	188095	220-240	A2 BAT	-15 to 55	max. 70	M10	54.0	102.5
2x49	T5	G5	2 x 49.0	ELXc 249.859	188617	220-240	A2 BAT	-15 to 50	max. 70	M10	113.0	106.6
54	T5	G5	1 x 54.0	ELXc 154.864	188142	220-240	A2 BAT	-15 to 55	max. 65	M10	59.0	101.1
2x54	T5	G5	2 x 54.0	ELXc 254.865	188618	220-240	A2 BAT	-15 to 50	max. 70	M10	119.0	106.0
80	T5	G5	1 x 80.0	ELXc 180.866	188144	220-240	A2 BAT	-15 to 55	max. 70	M10	87.0	97.6
2x80	T5	G5	2 x 80.0	ELXc 280.538	188619	220-240	A2 BAT	-15 to 50	max. 70	M11	175.0	97.2
For T8 lamps - Casing: M8												
3x18	T8	G13	3 x 16.0	ELXc 418.204	188744	220-240	A2 BAT	-15 to 55	max. 70	M8	56.0	100.8
4x18	T8	G13	4 x 16.0	ELXc 418.204	188744	220-240	A2 BAT	-15 to 55	max. 70	M8	71.5	98.9
3x36	T8	G13	3 x 32.0	ELXc 336.214	188595	220-240	A2 BAT	-15 to 50	max. 65	M8	105.0	99.4

Circuit diagrams see pages 238-241

ELXc EffectLine – Warm start

Warm start for T5 and T8 lamps – Casing: M6, M8 and M10

DC voltage

for operation: 176–264 V

for ignition: 198–264 V

(not possible for T8)

Push-in terminals with lever opener: 0.5–1.5 mm²

EOL shut down approved

acc. to EN 61347 Test 2 (for T5)

EOL shut down (for T8)

T5 TC BUILT-IN 1–10 V
 T8 INDEPENDENT DALI/PUSH

Lamp				Electronic ballast							System	
Output W	Type	Base	Power consumption W	Type	Ref. No.	Voltage AC 50, 60 Hz V±10%	Energy efficiency	Ambient temperature t _a (°C)	Casing temperature t _c (°C)	Casing	Output W	Luminous factor %

For T5 lamps – Casing: M6 and M10

14	T5	G5	1 x 14.3	ELXc 135.220	188921	220–240	A2 BAT	–15 to 55	max. 70	M6	17.0	104.8
2x14	T5	G5	2 x 14.3	ELXc 235.221	188922	220–240	A2 BAT	–15 to 55	max. 70	M10	34.5	101.9
21	T5	G5	1 x 20.4	ELXc 135.220	188921	220–240	A2 BAT	–15 to 55	max. 70	M6	23.3	106.9
2x21	T5	G5	2 x 21.4	ELXc 235.221	188922	220–240	A2 BAT	–15 to 55	max. 70	M10	48.3	104.9
28	T5	G5	1 x 26.7	ELXc 135.220	188921	220–240	A2 BAT	–15 to 55	max. 70	M6	29.9	107.5
2x28	T5	G5	2 x 28.7	ELXc 235.221	188922	220–240	A2 BAT	–15 to 55	max. 70	M10	62.1	109.0
35	T5	G5	1 x 32.6	ELXc 135.220	188921	220–240	A2 BAT	–15 to 55	max. 70	M6	36.5	103.0
2x35	T5	G5	2 x 35.6	ELXc 235.221	188922	220–240	A2 BAT	–15 to 55	max. 70	M10	78.2	100.8

For T8 lamps – Casing: M8

18	T8	G13	1 x 16.0	ELXc 136.207	188704	220–240	A2 BAT	–20 to 55	max. 60	M8	18.4	105.0
2x18	T8	G13	2 x 16.0	ELXc 236.208	188705	220–240	A2 BAT	–20 to 50	max. 60	M8	35.2	106.0
36	T8	G13	1 x 32.0	ELXc 136.207	188704	220–240	A2 BAT	–20 to 55	max. 60	M8	35.4	97.0
2x36	T8	G13	2 x 32.0	ELXc 236.208	188705	220–240	A2 BAT	–20 to 50	max. 60	M8	69.7	98.0
58	T8	G13	1 x 50.0	ELXc 158.209	188706	220–240	A2 BAT	–20 to 50	max. 60	M8	52.6	106.0
2x58	T8	G13	2 x 50.0	ELXc 258.210	188707	220–240	A2	–20 to 50	max. 65	M8	109.9	105.0

Circuit diagrams see pages 238–241

ELXc EffectLine II – Warm start

Warm start for T8 lamps – Casing: M8

DC voltage

for operation: 176–264 V

(DC voltage can be reduced to 176 V for 2 hours)

for ignition: 198–264 V

Push-in terminals with lever opener: 0.5–1.5 mm²

EOL 2 shut down

Lamp				Electronic ballast							System	
Output W	Type	Base	Power consumption W	Type	Ref. No.	Voltage AC 50, 60 Hz V±10%	Energy efficiency	Ambient temperature t _a (°C)	Casing temperature t _c (°C)	Casing	Output W	Luminous factor %
18	T8	G13	1 x 16.0	ELXc 136.216	188912	220–240	A2 BAT	–20 to 55	max. 65	M8	19.8	105.7
2x18	T8	G13	2 x 16.0	ELXc 236.217	188913	220–240	A2 BAT	–20 to 60	max. 70	M8	38.0	101.6
36	T8	G13	1 x 32.0	ELXc 136.216	188912	220–240	A2 BAT	–20 to 55	max. 65	M8	34.4	97.5
2x36	T8	G13	2 x 32.0	ELXc 236.217	188913	220–240	A2 BAT	–20 to 60	max. 70	M8	71.9	110.6
58	T8	G13	1 x 50.0	ELXc 158.218	188914	220–240	A2 BAT	–20 to 60	max. 65	M8	56.0	100.8
2x58	T8	G13	2 x 50.0	ELXc 258.219	188915	220–240	A2	–20 to 55	max. 70	M8	110.0	101.0

Circuit diagrams see pages 238–241

ELXc – Warm Start New T5 EffectLine

Electronic built-in ballasts

Casing: metal

Push-in terminals with lever opener: 0.5-1 mm²

RFI-suppressed

For luminaires of protection class I

Degree of protection: IP20

For lighting systems with

high switching frequency (> 5/day)

Automatic restart after lamp has been changed

Suitable for use in luminaires for emergency

lighting systems acc. to VDE 0108

EOL shut down approved acc. to EN 61347 Test 1

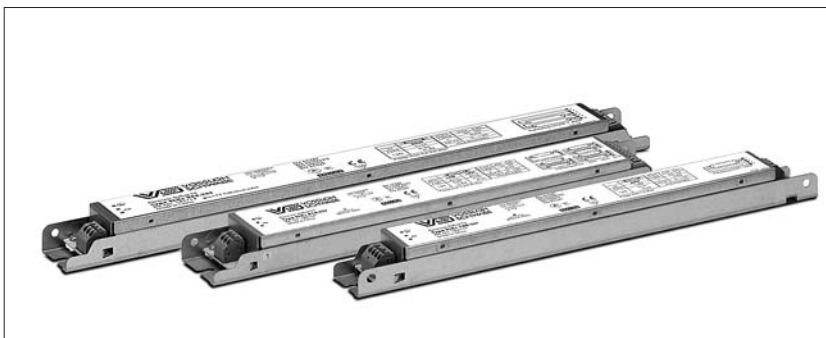

M7.1 / M10.2

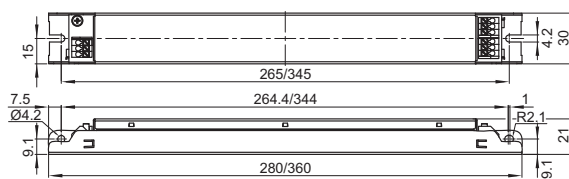

M7.2

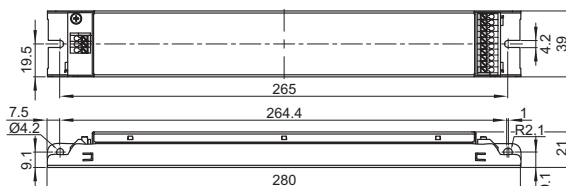

- T5
- TC
- BUILT-IN
- 1-10 V
- T8
- INDEPENDENT
- DALI/PUSH

Lamp				Electronic ballast										System	
Output W	Type	Base	Power consumption W	Type	Ref. No.	Voltage AC 50, 60 Hz V±10 %	Energy efficiency	Power factor	Ambient temperature t _a (°C)	Casing temperature t _c (°C)	Casing	L mm	W mm	Output W	Luminous factor %
14	T5 HE	G5	1 x 14.0	ELXc 228.229	183111	220-240	EEI=A2	> 0.90	0 to 50	max. 75	M7.1	280	30	16,5	100
				ELXc 135.231	183113	220-240	EEI=A2	> 0.90	0 to 50	max. 75	M7.1	280	30	16,5	100
2x14	T5 HE	G5	2 x 14.0	ELXc 228.229	183111	220-240	EEI=A2	> 0.92	0 to 50	max. 75	M7.1	280	30	31,0	100
3x14	T5 HE	G5	3 x 14.0	ELXc 414.227	183109	220-240	EEI=A2	> 0.95	0 to 50	max. 75	M7.2	280	39	48,0	100
4x14	T5 HE	G5	4 x 14.0	ELXc 414.227	183109	220-240	EEI=A2	> 0.95	0 to 50	max. 75	M7.2	280	39	63,0	100
21	T5 HE	G5	1 x 21.0	ELXc 228.229	183111	220-240	EEI=A2	> 0.90	0 to 50	max. 75	M7.1	280	30	24,0	100
				ELXc 135.231	183113	220-240	EEI=A2	> 0.92	0 to 50	max. 75	M7.1	280	30	24,0	100
2x21	T5 HE	G5	2 x 21.0	ELXc 228.229	183111	220-240	EEI=A2	> 0.95	0 to 50	max. 75	M7.1	280	30	47,5	100
24	T5 HO	G5	1 x 24.0	ELXc 239.233	183115	220-240	EEI=A2	> 0.90	0 to 50	max. 75	M7.1	280	30	28,0	100
2x24	T5 HO	G5	2 x 24.0	ELXc 239.233	183115	220-240	EEI=A2	> 0.95	0 to 50	max. 75	M7.1	280	30	53,5	100
3x24	T5 HO	G5	3 x 24.0	ELXc 424.228	183110	220-240	EEI=A2	> 0.95	0 to 50	max. 75	M7.2	280	39	76,0	100
4x24	T5 HO	G5	4 x 24.0	ELXc 424.228	183110	220-240	EEI=A2	> 0.95	0 to 50	max. 75	M7.2	280	39	100,0	100
28	T5 HE	G5	1 x 28.0	ELXc 228.229	183111	220-240	EEI=A2	> 0.92	0 to 50	max. 75	M7.1	280	30	31,0	100
				ELXc 135.231	183113	220-240	EEI=A2	> 0.95	0 to 50	max. 75	M7.1	280	30	32,0	100
2x28	T5 HE	G5	2 x 28.0	ELXc 228.229	183111	220-240	EEI=A2	> 0.95	0 to 50	max. 75	M7.1	280	30	61,0	100
				ELXc 328.230	183112	220-240	EEI=A2	> 0.95	0 to 50	max. 75	M7.2	280	39	61,0	100
3x28	T5 HE	G5	3 x 28.0	ELXc 328.230	183112	220-240	EEI=A2	> 0.95	0 to 50	max. 75	M7.2	280	39	94,0	100
35	T5 HE	G5	1 x 35.0	ELXc 135.231	183113	220-240	EEI=A2	> 0.95	0 to 50	max. 75	M7.1	280	30	38,0	100
2x35	T5 HE	G5	2 x 35.0	ELXc 235.232	183114	220-240	EEI=A2	> 0.95	0 to 50	max. 75	M10.2	360	30	74,0	100
39	T5 HO	G5	1 x 39.0	ELXc 239.233	183115	220-240	EEI=A2	> 0.92	0 to 50	max. 75	M7.1	280	30	43,5	100
2x39	T5 HO	G5	2 x 39.0	ELXc 239.233	183115	220-240	EEI=A2	> 0.95	0 to 50	max. 75	M7.1	280	30	83,0	100
49	T5 HO	G5	1 x 49.0	ELXc 149.234	183116	220-240	EEI=A2	> 0.95	0 to 50	max. 75	M7.1	280	30	51,0	100
2x49	T5 HO	G5	2 x 49.0	ELXc 249.235	183117	220-240	EEI=A2	> 0.95	0 to 50	max. 75	M10.2	360	30	108,0	100
54	T5 HO	G5	1 x 54.0	ELXc 254.236	183118	220-240	EEI=A2	> 0.92	0 to 50	max. 75	M7.1	280	30	58,0	100
2x54	T5 HO	G5	2 x 54.0	ELXc 254.236	183118	220-240	EEI=A2	> 0.95	0 to 50	max. 75	M7.1	280	30	113,0	100
80	T5 HO	G5	1 x 80.0	ELXc 180.237	183119	220-240	EEI=A2	> 0.95	0 to 50	max. 75	M7.1	280	30	86,0	100

Preliminary data

ELXc – ECO EffectLine Warm Start for T5 and T8 Lamps

Electronic built-in ballasts

Casing: PC, white

Push-in terminals with lever opener: 0.5-1.5 mm²

RFI-suppressed

For luminaires of protection class I

Degree of protection: IP20

For lighting systems with

high switching frequency (> 5/day)

EOL shut down approved acc. to EN 61347 Test 1

(for T5 lamps); EOL shut down (for T8 lamps)

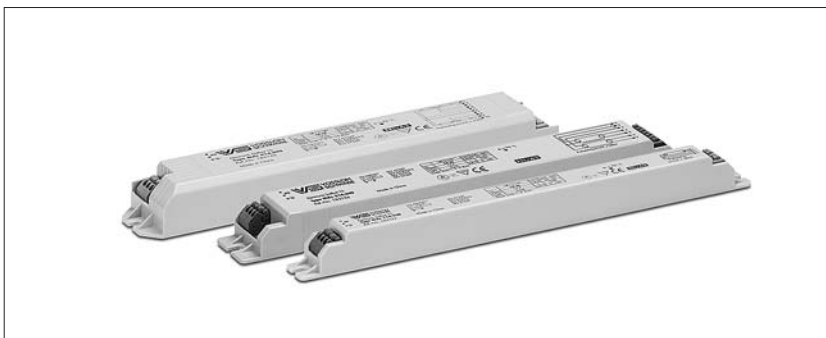

K7.1 / K7.2

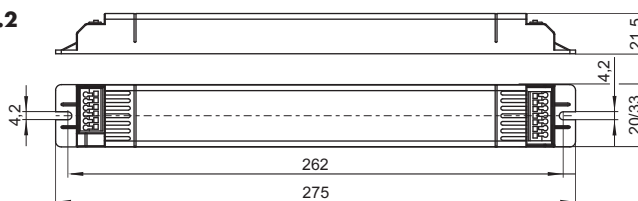

K5.1 / K5.2

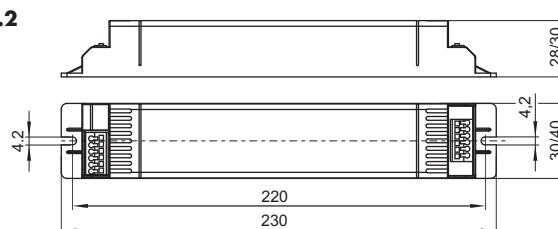

- T5 TC BUILT-IN 1-10 V
- T8 INDEPENDENT DALI/PUSH

Lamp				Electronic ballast										System	
Output	Type	Base	Power consumption	Type	Ref. No.	Voltage AC	Energy efficiency	Power factor	Ambient temperature	Casing temperature	Casing	W	H	Output	Luminous factor
W			W			50, 60 Hz			t _a (°C)	t _c (°C)	W	mm	mm	W	%
V±10 %															
For T5 lamps															
14	T5 HE	G5	1 x 14.8	ELXc 114.238	183122	220-240	A2	> 0.95	0 to 50	max. 75	K7.1	20	21.5	17.0	100
2x14	T5 HE	G5	2 x 14.5	ELXc 214.240	183124	220-240	A2	> 0.95	0 to 50	max. 75	K7.2	33	21.5	33.0	100
4x14	T5 HE	G5	4 x 14.0	ELXc 414.242	183126	220-240	A2	> 0.95	0 to 50	max. 75	K5.2	40	30	64.0	100
28	T5 HE	G5	1 x 28.5	ELXc 128.239	183123	220-240	A2	> 0.95	0 to 50	max. 75	K7.1	20	21.5	31.5	100
2x28	T5 HE	G5	2 x 26.5	ELXc 228.241	183125	220-240	A2	> 0.95	0 to 50	max. 75	K7.2	33	21.5	59.0	95
For T8 lamps															
18	T8	G13	1 x 15.5	ELXc 118.243	183127	220-240	A2	> 0.95	-15 to 50	max. 70	K5.1	30	28	18.5	98
2x18	T8	G13	2 x 15.5	ELXc 218.246	183130	220-240	A2	> 0.96	-15 to 50	max. 70	K5.1	30	28	35.0	98
4x18	T8	G13	4 x 15.5	ELXc 418.249	183133	220-240	A2	> 0.98	-15 to 50	max. 70	K5.2	40	30	69.0	97
36	T8	G13	1 x 30.5	ELXc 136.244	183128	220-240	A2	> 0.96	-15 to 50	max. 70	K5.1	30	28	34.0	95
2x36	T8	G13	2 x 31.0	ELXc 236.247	183131	220-240	A2	> 0.98	-15 to 50	max. 70	K5.2	40	30	68.0	97
58	T8	G13	1 x 48.0	ELXc 158.245	183129	220-240	A2	> 0.96	-15 to 50	max. 70	K5.1	30	28	53.5	96
2x58	T8	G13	2 x 49.5	ELXc 258.248	183132	220-240	A2	> 0.98	-15 to 50	max. 80	K5.2	40	30	107.0	100

Preliminary data

ELXd – Dimmable for T5 and T8 Lamps

Electronic built-in ballasts

Casing: metal

Power factor: ≥ 0.95 at 100% operation

DC voltage

for operation: 154–276 V (M22, M23, M24)

for operation: 176–264 V (M9)

for ignition: 198–264 V

For the automatic luminaire wiring:

IDC terminals for leads HO5V-U 0.5

RFI-suppressed

For luminaires of protection class I

Degree of protection: IP20

For lighting systems with

high switching frequency ($> 5/\text{day}$)

Suitable for use in luminaires for emergency

lighting systems acc. to VDE 0108

M9

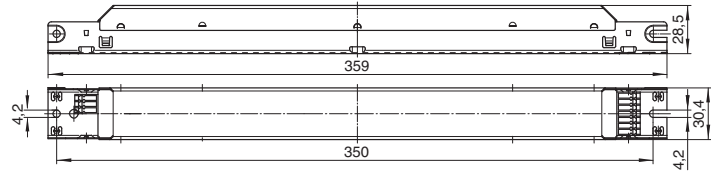

M10/M11

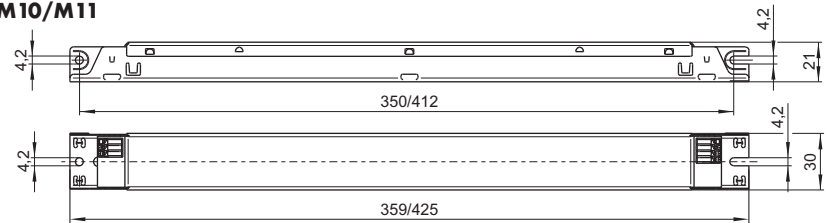

M23

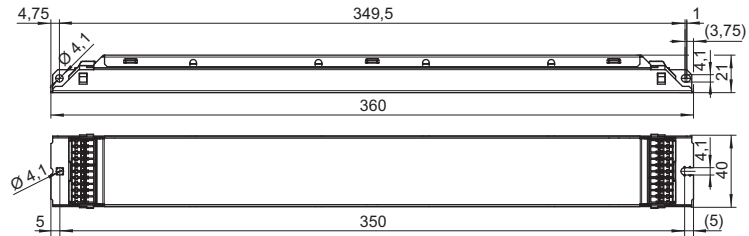

M22/M24

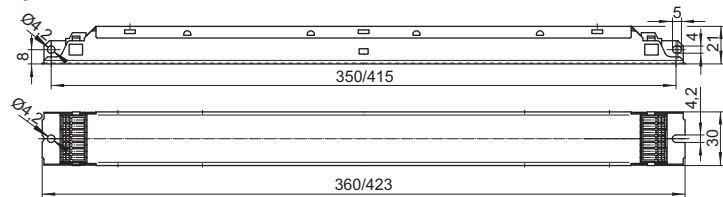

- 1
- 2
- 3
- 4
- 5
- 6
- 7
- 8
- 9
- 10

ELXd – Dimmable 1–10 V with lamp detection

Dimming range:

approx. 1–100% of lamp power

(*3–100 %: ELXd 135.823, 235.735, 118.718, 218.719, 136.720, 236.721, 158.722, 258.723)

Control voltage: DC 1–10 V acc. to EN 60929

with earth leakage current 0.5 mA

(protected if connected to mains voltage)

For use with open- or closed-loop control units

Push-in terminals: 0.5–1 mm²

EOL shut down approved

acc. to EN 61347 Test 2 (for T5)

EOL 2 shut down (for T8)



Lamp				Electronic ballast							System	
Output W	Type	Base	Power consumption W	Type	Ref. No.	Voltage AC 50, 60 Hz V±10%	Energy efficiency	Ambient temperature t _a (°C)	Casing temperature t _c (°C)	Casing	Output W	Luminous factor %
T5 lamps – Casing: M10, M22, M23 and M24												
14	T5	G5	1 x 14.0	ELXd 135.823	188717*	220–240	A1 BAT	10 to 55	max. 65	M10	17.0	99.5
				ELXd 124.607	188336	220–240	A1 BAT	10 to 50	max. 75	M22	16.0	100.0
2x14	T5	G5	2 x 13.6	ELXd 235.735	183059*	220–240	A1 BAT	10 to 50	max. 70	M11	33.4	98.7
			2 x 14.0	ELXd 224.608	188337	220–240	A1 BAT	10 to 50	max. 75	M24	31.0	100.0
3x14	T5	G5	3 x 14.0	ELXd 324.623	188597	220–240	A1 BAT	10 to 50	max. 75	M23	45.3	100.0
4x14	T5	G5	4 x 14.0	ELXd 424.624	188598	220–240	A1 BAT	10 to 50	max. 75	M23	60.4	100.0
21	T5	G5	1 x 21.0	ELXd 135.823	188717*	220–240	A1 BAT	10 to 55	max. 65	M10	24.0	99.0
				ELXd 139.609	188338	220–240	A1 BAT	10 to 50	max. 75	M22	23.0	100.0
2x21	T5	G5	2 x 20.5	ELXd 235.735	183059*	220–240	A1 BAT	10 to 50	max. 70	M11	47.0	95.1
			2 x 21.0	ELXd 239.610	188339	220–240	A1 BAT	10 to 50	max. 75	M24	45.0	100.0
24	T5	G5	1 x 23.0	ELXd 124.607	188336	220–240	A1 BAT	10 to 50	max. 75	M22	26.0	100.0
2x24	T5	G5	2 x 23.0	ELXd 224.608	188337	220–240	A1 BAT	10 to 50	max. 75	M24	50.0	100.0
3x24	T5	G5	3 x 23.0	ELXd 324.623	188597	220–240	A1 BAT	10 to 50	max. 75	M23	73.4	100.0
4x24	T5	G5	4 x 23.0	ELXd 424.624	188598	220–240	A1 BAT	10 to 50	max. 75	M23	97.6	100.0
28	T5	G5	1 x 28.0	ELXd 135.823	188717*	220–240	A1 BAT	10 to 55	max. 65	M10	32.0	98.6
				ELXd 154.611	188340	220–240	A1 BAT	10 to 50	max. 75	M22	31.0	100.0
2x28	T5	G5	2 x 27.3	ELXd 235.735	183059*	220–240	A1 BAT	10 to 50	max. 70	M11	62.1	97.6
			2 x 28.0	ELXd 254.612	188341	220–240	A1 BAT	10 to 50	max. 75	M24	61.0	100.0
35	T5	G5	1 x 35.0	ELXd 135.823	188717*	220–240	A1 BAT	10 to 55	max. 65	M10	38.0	95.0
				ELXd 180.613	188342	220–240	A1 BAT	10 to 50	max. 75	M22	38.0	100.0
2x35	T5	G5	2 x 33.9	ELXd 235.735	183059*	220–240	A1 BAT	10 to 50	max. 70	M11	76.9	96.7
			2 x 35.0	ELXd 249.614	188343	220–240	A1 BAT	10 to 50	max. 75	M24	75.0	100.0
				ELXd 280.630	188604	220–240	A1 BAT	10 to 50	max. 75	M24	75.0	100.0
39	T5	G5	1 x 38.0	ELXd 139.609	188338	220–240	A1 BAT	10 to 50	max. 75	M22	42.0	100.0
2x39	T5	G5	2 x 38.0	ELXd 239.610	188339	220–240	A1 BAT	10 to 50	max. 75	M24	82.0	100.0
49	T5	G5	1 x 49.0	ELXd 180.613	188342	220–240	A1 BAT	10 to 50	max. 75	M22	54.0	100.0
2x49	T5	G5	2 x 49.0	ELXd 249.614	188343	220–240	A1 BAT	10 to 50	max. 75	M24	104.0	100.0
				ELXd 280.630	188604	220–240	A1 BAT	10 to 50	max. 75	M24	104.0	100.0
54	T5	G5	1 x 54.0	ELXd 154.611	188340	220–240	A1 BAT	10 to 50	max. 75	M22	59.0	100.0
2x54	T5	G5	2 x 54.0	ELXd 254.612	188341	220–240	A1 BAT	10 to 50	max. 75	M24	115.0	100.0
80	T5	G5	1 x 80.0	ELXd 180.613	188342	220–240	A1 BAT	10 to 50	max. 75	M22	88.0	100.0
2x80	T5	G5	2 x 80.0	ELXd 280.630	188604	220–240	A1 BAT	10 to 50	max. 75	M24	165.0	100.0
T8 lamps – Casing: M9												
18	T8	G13	1 x 16.0	ELXd 118.718	188873*	220–240	EEI=A1	10 to 50	max. 70	M9	21.0	102.1
2x18	T8	G13	2 x 16.0	ELXd 218.719	188874*	220–240	EEI=A1	10 to 50	max. 70	M9	41.5	104.6
36	T8	G13	1 x 32.0	ELXd 136.720	188875*	220–240	A1 BAT	10 to 50	max. 70	M9	37.3	101.6
2x36	T8	G13	2 x 32.0	ELXd 236.721	188876*	220–240	EEI=A1	10 to 50	max. 70	M9	72.0	98.9
58	T8	G13	1 x 50.0	ELXd 158.722	188877*	220–240	A1 BAT	10 to 50	max. 70	M9	55.0	101.3
2x58	T8	G13	2 x 50.0	ELXd 258.723	188878*	220–240	EEI=A1	10 to 50	max. 75	M9	109.0	96.5

Circuit diagrams see pages 238–241

ELXd – Dimmable with push key or DALI with lamp detection

Dimming range:

approx. 1–100% of lamp power

PUSH: dimmable with usual push key

DALI: poles are not polarity sensitive
(protected if connected to mains voltage)
for use with DALI compatible control units

Push-in terminals: 0,5-1 mm²

EOL shut down approved

acc. to EN 61347 Test 2 (for T5)

EOL 2 shut down (for T8)

standby power consumption: ≤ 0.2 W

Complete implementation of the DALI-standard:
addressable, memory store for scenes and groups,
revertive information communication, physical and
RND-selection, standardized lamp characteristic
Low-power design ensures very low standby
power consumption
Compatible with IEC 62386

T5 TC BUILT-IN 1-10 V
 T8 INDEPENDENT DALI/PUSH

Lamp				Electronic ballast							System	
Output W	Type	Base	Power consumption W	Type	Ref. No.	Voltage AC 50, 60 Hz V±10%	Energy efficiency	Ambient temperature t _a [°C]	Casing temperature t _c [°C]	Casing	Output W	Luminous factor %
For T5 lamps - Casing: M10, M11, M22, M23 and M24												
14	T5	G5	1 x 13.7	ELXd 135.724	188932	220-240	A1 BAT	10 to 50	max. 65	M10	16.4	102.6
			1 x 14.0	ELXd 124.600	188329	220-240	A1 BAT	10 to 50	max. 75	M22	16.0	100.0
2x14	T5	G5	2 x 13.6	ELXd 235.725	188933	220-240	A1 BAT	10 to 50	max. 70	M11	33.4	96.7
			2 x 14.0	ELXd 224.601	188330	220-240	A1 BAT	10 to 50	max. 75	M24	31.0	100.0
3x14	T5	G5	3 x 14.0	ELXd 324.626	188600	220-240	A1 BAT	10 to 50	max. 75	M23	45.3	100.0
4x14	T5	G5	4 x 14.0	ELXd 424.628	188602	220-240	A1 BAT	10 to 50	max. 75	M23	60.4	100.0
21	T5	G5	1 x 20.7	ELXd 135.724	188932	220-240	A1 BAT	10 to 50	max. 65	M10	24.3	102.7
			1 x 21.0	ELXd 139.602	188331	220-240	A1 BAT	10 to 50	max. 75	M22	23.0	100.0
2x21	T5	G5	2 x 20.5	ELXd 235.725	188933	220-240	A1 BAT	10 to 50	max. 70	M11	47.0	97.6
			2 x 21.0	ELXd 239.621	188350	220-240	A1 BAT	10 to 50	max. 75	M24	45.0	100.0
24	T5	G5	1 x 23.0	ELXd 124.600	188329	220-240	A1 BAT	10 to 50	max. 75	M22	26.0	100.0
2x24	T5	G5	2 x 23.0	ELXd 224.601	188330	220-240	A1 BAT	10 to 50	max. 75	M24	50.0	100.0
3x24	T5	G5	3 x 23.0	ELXd 324.626	188600	220-240	A1 BAT	10 to 50	max. 75	M23	73.4	100.0
4x24	T5	G5	4 x 23.0	ELXd 424.628	188602	220-240	A1 BAT	10 to 50	max. 75	M23	97.6	100.0
28	T5	G5	1 x 27.8	ELXd 135.724	188932	220-240	A1 BAT	10 to 50	max. 65	M10	32.0	104.1
			1 x 28.0	ELXd 154.603	188332	220-240	A1 BAT	10 to 50	max. 75	M22	31.0	100.0
2x28	T5	G5	2 x 27.3	ELXd 235.725	188933	220-240	A1 BAT	10 to 50	max. 70	M11	62.1	95.1
			2 x 28.0	ELXd 254.604	188333	220-240	A1 BAT	10 to 50	max. 75	M24	61.0	100.0
35	T5	G5	1 x 34.7	ELXd 135.724	188932	220-240	A1 BAT	10 to 50	max. 65	M10	40.0	107.5
			1 x 35.0	ELXd 180.605	188334	220-240	A1 BAT	10 to 50	max. 75	M22	38.0	100.0
2x35	T5	G5	2 x 33.9	ELXd 235.725	188933	220-240	A1 BAT	10 to 50	max. 70	M11	76.9	98.7
			2 x 35.0	ELXd 280.631	188605	220-240	A1 BAT	10 to 50	max. 75	M24	74.0	100.0
				ELXd 249.606	188335	220-240	A1 BAT	10 to 50	max. 75	M24	75.0	100.0
39	T5	G5	1 x 38.0	ELXd 139.602	188331	220-240	A1 BAT	10 to 50	max. 75	M22	42.0	100.0
2x39	T5	G5	2 x 38.0	ELXd 239.621	188350	220-240	A1 BAT	10 to 50	max. 75	M24	82.0	100.0
49	T5	G5	1 x 49.0	ELXd 180.605	188334	220-240	A1 BAT	10 to 50	max. 75	M22	54.0	100.0
2x49	T5	G5	2 x 49.0	ELXd 280.631	188605	220-240	A1 BAT	10 to 50	max. 75	M24	101.0	100.0
				ELXd 249.606	188335	220-240	A1 BAT	10 to 50	max. 75	M24	104.0	100.0
54	T5	G5	1 x 54.0	ELXd 154.603	188332	220-240	A1 BAT	10 to 50	max. 75	M22	59.0	100.0
2x54	T5	G5	2 x 54.0	ELXd 254.604	188333	220-240	A1 BAT	10 to 50	max. 75	M24	115.0	100.0
80	T5	G5	1 x 80.0	ELXd 180.605	188334	220-240	A1 BAT	10 to 50	max. 75	M22	88.0	100.0
2x80	T5	G5	2 x 80.0	ELXd 280.631	188605	220-240	A1 BAT	10 to 50	max. 75	M24	165.0	100.0

Circuit diagrams see pages 238-241

Accessories for Dimmable Electronic Ballasts

Manual controller

Dimmer for EB with low-voltage interface 1 - 10 V

Dimensions: 67x67x51 mm

Push-button change-over switch with stud 4 mm for installation in flush-type boxes with \varnothing 55 mm

Max. 50 EBs per dimmer

Weight: 60/30 g, unit: 25 pcs.

Without cover plate

Ref. No.: 172778

Cover plate with rotary knob

Dimensions: 80x80x9 mm

Ref. No.: 172775 white

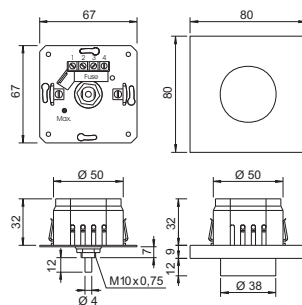

Light sensor

Constant light control with clamp fastening for fluorescent lamps T8 (T26) and compact fluorescent lamps

Dimensions: 33.5x40x96 mm

With connection lead: 2x0.24 mm²

Length: 800 mm

Max. 50 EBs per light sensor

Weight: 55 g, unit: 60 pcs.

Ref. No.: 172776

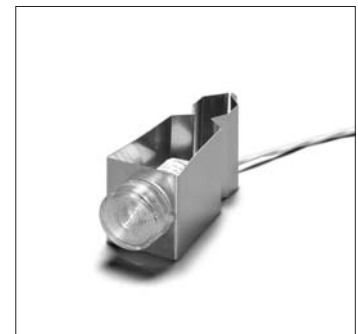
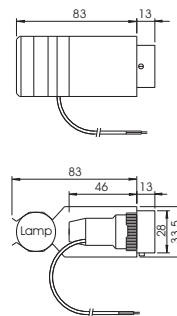

Multi sensor

Dimensions: 58.5x70.5x42 mm

With the sensor the lighting can be kept on a pre-defined level

With integrated motion detector

Max. 50 EBs per multi sensor

Weight: 125 g, unit: 25 pcs.

Ref. No.: 172777

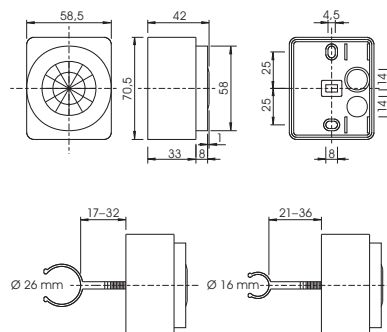

1

2

3

4

5

6

7

8

9

10

RELIABLE AND
DURABLE

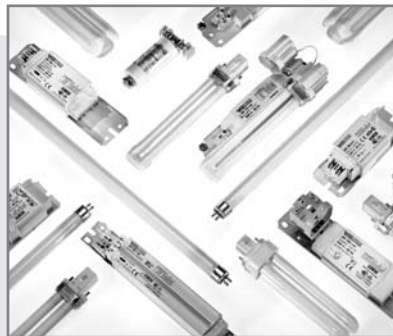

ELECTROMAGNETIC BALLASTS

The following chapter presents Vossloh-Schwabe's broad range of electromagnetic ballasts for compact fluorescent lamps and tubular fluorescent lamps. The variety of available performance properties and shapes satisfies the most diverse design requirements.

Vossloh-Schwabe's electromagnetic ballasts are characterized by extremely tight impedance-value tolerances, which are achieved by individual adjustment of the air gap during the automated production and testing process of the ballasts. This optimises both light output as well as the service life of fluorescent lamps.

3

Electromagnetic Ballasts for TC and T Lamps

Electromagnetic ballasts for compact fluorescent lamps

Standard ballasts
Ballasts 120 V, 60 Hz

154–158

154–157
158

Electromagnetic ballasts for tubular fluorescent lamps

Super low-loss ballasts
Standard ballasts
Ballasts 120 V, 60 Hz

159–163

159
160–162
163

Technical details for fluorescent lamps

General technical details
Glossary

226–253

366–374
375–377

1

2

3

4

5

6

7

8

9

10

Standard Ballasts 5–16 W, 230/240/220 V

For compact fluorescent lamps
Shape: 28 x 41 mm

Vacuum-impregnated with polyester resin

Push-in terminal for leads: 0.5–1 mm²

For the automatic luminaire wiring:

IDC terminals for leads HO5V-U 0.5

tw 130

Protection class I

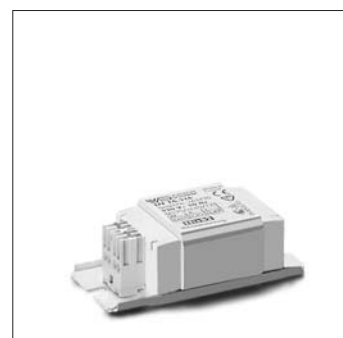
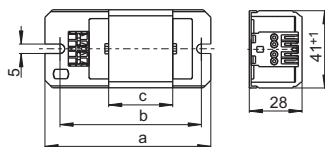

Lamp				Ballast										Capacitor	
Output	Type	Base	Current	Type	Ref. No.	Voltage	a	b	c	Weight	$\Delta t/\Delta t_{on}$	Energy efficiency*	C _p	Current	
W			mA			V, Hz	mm	mm	mm	kg	K		μ F	mA	
230 V, 50 Hz															
5	TC-S	G23	180	L7/9/11.307	163694	230, 50	85	75	34	0.32	60/85	B2	2.0	50	
2x5	TC-S	G23	180	LN 13.805	169647	230, 50	85	75	34	0.32	50/85	B1	2.0	70	
				LN 13.313	163711	230, 50	85	75	34	0.32	55/80	B2	2.0	70	
7	TC-S	G23	175	L7/9/11.307	163694	230, 50	85	75	34	0.32	60/85	B2	2.0	50	
2x7	TC-S	G23	160	LN 13.805	169647	230, 50	85	75	34	0.32	50/85	B1	2.0	70	
				LN 13.313	163711	230, 50	85	75	34	0.32	55/80	B2	2.0	70	
9	TC-S	G23	170	L7/9/11.307	163694	230, 50	85	75	34	0.32	60/85	B1	2.0	60	
2x9	TC-S	G23	140	LN 13.805	169647	230, 50	85	75	34	0.32	50/85	B1	2.0	70	
				LN 13.313	163711	230, 50	85	75	34	0.32	55/80	B2	2.0	80	
10	TC-D	G24d-1	190	LN 13.805	169647	230, 50	85	75	34	0.32	50/85	B1	2.0	70	
				LN 13.313	163711	230, 50	85	75	34	0.32	55/80	B2	2.0	70	
	TC-DD	GR10q	180	LN 13.805	169647	230, 50	85	75	34	0.32	50/85	B1	2.0	70	
				LN 13.313	163711	230, 50	85	75	34	0.32	55/80	B2	2.0	70	
11	TC-S	G23	155	L7/9/11.307	163694	230, 50	85	75	34	0.32	60/85	B1	2.0	80	
13	TC-D/TC-T	G24d-1/GX24d-1	175	LN 13.805	169647	230, 50	85	75	34	0.32	50/85	B1	2.0	80	
				LN 13.313	163711	230, 50	85	75	34	0.32	55/80	B2	2.0	80	
16	TC-DD	GR8/GR10q	195	LN 16.316	163730	230, 50	85	75	34	0.32	60/125	B1	2.0	100	
240 V, 50 Hz															
5	TC-S	G23	180	L7/9/11.411	164335	240, 50	85	75	34	0.32	60/85	B2	2.0	50	
2x5	TC-S	G23	180	LN 13.413	164342	240, 50	85	75	34	0.32	60/90	B2	2.0	70	
7	TC-S	G23	175	L7/9/11.411	164335	240, 50	85	75	34	0.32	60/85	B2	2.0	50	
2x7	TC-S	G23	160	LN 13.413	164342	240, 50	85	75	34	0.32	60/90	B2	2.0	70	
9	TC-S	G23	170	L7/9/11.411	164335	240, 50	85	75	34	0.32	60/85	B1	2.0	60	
2x9	TC-S	G23	140	LN 13.413	164342	240, 50	85	75	34	0.32	60/90	B2	2.0	80	
10	TC-D	G24d-1	190	LN 13.413	164342	240, 50	85	75	34	0.32	60/90	B2	2.0	70	
				TC-DD	GR10q	180	LN 13.413	164342	240, 50	85	75	34	0.32	60/90	B2
11	TC-S	G23	155	L7/9/11.411	164335	240, 50	85	75	34	0.32	60/85	B1	2.0	80	
13	TC-D/TC-T	G24d-1/GX24d-1	175	LN 13.413	164342	240, 50	85	75	34	0.32	60/90	B1	2.0	80	
16	TC-DD	GR8/GR10q	195	LN 16.417	164358	240, 50	85	75	34	0.32	60/130	B1	2.0	100	
220 V, 60 Hz															
5	TC-S	G23	180	L7/9/11.207	163305	220, 60	85	75	34	0.32	35/65	–	2.0	70	
2x5	TC-S	G23	180	L 13.210	520992	220, 60	85	75	34	0.32	45/80	–	2.0	90	
7	TC-S	G23	175	L7/9/11.207	163305	220, 60	85	75	34	0.32	35/65	–	2.0	70	
2x7	TC-S	G23	160	L 13.210	520992	220, 60	85	75	34	0.32	45/80	–	2.0	90	
9	TC-S	G23	170	L7/9/11.207	163305	220, 60	85	75	34	0.32	35/65	–	2.0	70	
2x9	TC-S	G23	140	L 13.210	520992	220, 60	85	75	34	0.32	45/80	–	2.0	90	
10	TC-D	G24d-1	190	L 13.210	520992	220, 60	85	75	34	0.32	45/80	–	2.0	80	
				TC-DD	GR10q	180	L 13.210	520992	220, 60	85	75	34	0.32	45/80	–
11	TC-S	G23	155	L7/9/11.207	163305	220, 60	85	75	34	0.32	35/65	–	2.0	80	
13	TC-D/TC-T	G24d-1/GX24d-1	165	L 13.210	520992	220, 60	85	75	34	0.32	45/80	–	2.0	110	

* Energy efficiency: EEI=B2 and EEI=B1, valid until 2017

Standard Ballasts 18–58 W, 230 V

For compact fluorescent lamps
Shape: 28 x 41 mm

Vacuum-impregnated with polyester resin

Push-in terminal for leads: 0.5–1 mm²

For the automatic luminaire wiring:

IDC terminals for leads H05V-U 0.5

tw 130

Protection class I

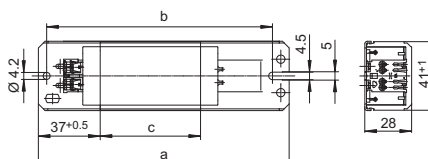

Lamp				Ballast										Capacitor	
Output	Type	Base	Current	Type	Ref. No.	Voltage	a	b	c	Weight	$\Delta t / \Delta t_{an}$	Energy efficiency*	C _p	Current	
W			mA			V, Hz	mm	mm	mm	kg	K		μF	mA	
230 V, 50 Hz															
18	TC-D/TC-T	G24d-2/GX24d-2	220	LN 181.940	508922	230, 50	85	75	34	0.32	50/120	B1	2.0	110	
				LN 181.319	163763	230, 50	85	75	34	0.32	60/140	B1	2.0	110	
	TC-F/TC-L	2G10/2G11	370	LN 18.510	164572	230, 50	155	140	92	0.80	40/65	B1	4.5	120	
				LN 18.131	530941	230, 50	150	140	60	0.55	55/95	B2	4.5	120	
	T-U	2G13	370	L 18.934**	534621	230, 50	150	140	45	0.43	70/150	–	4.5	120	
				LN 18.131	530941	230, 50	150	140	60	0.55	55/95	B2	4.5	120	
				L 18.934**	534621	230, 50	150	140	45	0.43	70/150	–	4.5	120	
2x18	TC-F/TC-L	2G10/2G11	400	LN 2x18.135	532155	230, 50	150	140	45	0.43	65	B1	4.0	210	
22	T-R	G10q	400	LN 30.530	164680	230, 50	155	140	92	0.80	45/65	B2	4.5	200	
24	TC-F/TC-L	2G10/2G11	345	LN 24/26.804	534490	230, 50	150	140	60	0.55	55/110	B2	4.5	150	
				L 18.934**	534621	230, 50	150	140	45	0.43	70/150	–	4.5	150	
26	TC-D/TC-T	G24d-3/GX24d-3	325	LN 18.131	530941	230, 50	150	140	60	0.55	55/95	B1	3.5	140	
				LN 26.813	509502	230, 50	110	100	45	0.41	55/145	B2	3.5	140	
				L 18.934**	534621	230, 50	150	140	45	0.43	70/150	–	3.5	140	
28	TC-DD	GR8/GR10q	320	LN 18.510	164572	230, 50	155	140	92	0.80	40/65	B1	3.5	150	
				LN 18.131	530941	230, 50	150	140	60	0.55	55/95	B1	3.5	150	
				L 18.934**	534621	230, 50	150	140	45	0.43	70/150	–	3.5	150	
32	T-R	G10q	450	LN 36.570	169779	230, 50	155	140	92	0.80	35/90	B2	4.0	220	
36	TC-F/TC-L	2G10/2G11	430	LN 36.570	169779	230, 50	155	140	92	0.80	35/90	B1	4.5	210	
				LN 36.511	164590	230, 50	155	140	92	0.80	35/95	B1	4.5	210	
				LN 36.130	527191	230, 50	150	140	60	0.55	50/140	B2	4.5	210	
				LN 36.149	529029	230, 50	150	140	60	0.55	55/150	B2	4.5	210	
				L 36.132**	535977	230, 50	150	140	45	0.43	65	–	4.5	210	
36/40	T-U/T-R	2G13/G10q	430	LN 36.570	169779	230, 50	150	140	92	0.80	35/90	B1	4.5	210	
				LN 36.149	529029	230, 50	150	140	60	0.55	55/150	B2	4.5	210	
				L 36.132**	535977	230, 50	150	140	45	0.43	65	–	4.5	210	
38	TC-DD	GR10q	430	LN 36.570	169779	230, 50	155	140	92	0.80	35/90	B1	4.5	210	
				LN 36.149	529029	230, 50	150	140	60	0.55	55/150	B2	4.5	210	
				L 36.132**	535977	230, 50	150	140	45	0.43	65	–	4.5	210	
				LN 58.568	169389	230, 50	233	220	160	1.31	35/95	B1	7.0	320	
58	T-U	2G13	670	LN 58.990	509349	230, 50	190	180	110	0.95	50/130	B2	7.0	320	
				LN 58.116	508186	230, 50	190	180	92	0.80	55/160	B2	7.0	320	
				L 58.718**	169658	230, 50	190	180	92	0.80	60/170	–	7.0	320	

* Energy efficiency: EEI=B2 and EEI=B1, valid until 2017

** Ballasts without CE mark for markets outside of the EU

Standard Ballasts 18–58 W, 240 V

For compact fluorescent lamps
Shape: 28 x 41 mm

Lamp				Ballast									Capacitor	
Output	Type	Base	Current	Type	Ref. No.	Voltage	a	b	c	Weight	$\Delta t/\Delta t_{on}$	Energy efficiency*	C _p	Current
W			mA			V, Hz	mm	mm	mm	kg	K		μF	mA
240 V, 50 Hz														
18	TC-D/TC-T	G24d-2/GX24d-2	220	LN 18.1418	164353	240, 50	85	75	34	0.28	60/130	B1	2.0	110
				LN 18.507	164566	240, 50	155	140	92	0.80	35/60	B1	4.5	120
					533043	240, 50	150	140	60	0.55	60/110	B2	4.5	120
	T-U	2G13	370	L 18.936**	534627	240, 50	150	140	45	0.43	70/140	–	4.5	120
				LN 18.507	164566	240, 50	155	140	92	0.80	35/60	B1	4.5	120
				LN 18.162	533043	240, 50	150	140	60	0.55	60/110	B2	4.5	120
2x18	TC-F/TC-L	2G10/2G11	400	LN 2x18.135	535778	240, 50	150	140	45	0.43	65	B1	4.0	210
				LN 36.201	527196	240, 50	150	140	60	0.55	55/140	B1	4.0	210
				LN 36.505	164555	240, 50	155	140	92	0.80	40/95	B1	4.0	210
21	TC-DD	GR10q	260	LN 21.293	547145	240, 50	105	95	45	0.41	55	B1	3.0	120
24	TC-F/TC-L	2G10/2G11	345	LN 18.507	164566	240, 50	155	140	92	0.80	35/60	B1	4.5	150
				LN 18.162	533043	240, 50	150	140	60	0.55	60/110	B2	4.5	150
				L 18.936**	534627	240, 50	150	140	45	0.43	70/140	–	4.5	150
26	TC-D/TC-T	G24d-3/GX24d-3	325	LN 18.162	533043	240, 50	150	140	60	0.55	60/110	B1	4.5	150
				LN 26.238	545405	240, 50	105	95	45	0.41	55/145	B2	3.5	140
28	TC-DD	GR8/GR10q	320	LN 18.162	533043	240, 50	150	140	60	0.55	60/110	B1	3.5	150
				L 18.936**	534627	240, 50	150	140	45	0.43	70/140	–	3.5	150
32	T-R	G10q	450	LN 36.505	164555	240, 50	155	140	92	0.80	40/95	B1	4.0	220
36	TC-F/TC-L	2G10/2G11	430	LN 36.505	164555	240, 50	155	140	92	0.80	40/95	B1	4.5	210
				LN 36.201	527196	240, 50	155	140	60	0.55	55/140	B2	4.5	210
				L 36/40.443**	164438	240, 50	150	140	60	0.55	65/155	–	4.5	210
36/40	T-U/T-R	2G13/G10q	430	LN 36.505	164555	240, 50	155	140	92	0.80	40/95	B1	4.5	210
				LN 36.201	527196	240, 50	150	140	60	0.55	55/140	B2	4.5	210
				L 36/40.443**	164438	240, 50	150	140	60	0.55	65/155	–	4.5	210
38	TC-DD	GR10q	430	LN 36.201	527196	240, 50	150	140	60	0.55	55/140	B2	4.5	210
				L 36/40.443**	164438	240, 50	150	140	60	0.55	65/155	–	4.5	210
58	T-U	2G13	670	LN 58.506	164560	240, 50	233	220	160	1.31	35/85	B1	7.0	320
				LN 58.192	507936	240, 50	190	180	110	0.95	50/150	B2	7.0	320
				LN 58.722	534252	240, 50	190	180	92	0.80	60/180	B2	7.0	320

* Energy efficiency: EEI=B2 and EEI=B1, valid until 2017

** Ballasts without CE mark for markets outside of the EU

Standard Ballasts 18–58 W, 220 V

For compact fluorescent lamps

Shape: 28 x 41 mm

Lamp				Ballast									Capacitor	
Output	Type	Base	Current	Type	Ref. No.	Voltage	a	b	c	Weight	$\Delta t/\Delta t_{on}$	Energy efficiency*	C _p	Current
W			mA			V, Hz	mm	mm	mm	kg	K		μF	mA
220 V, 50 Hz														
18	TC-F/TC-L	2G10/2G11	370	L18.933	534624	220,50	150	140	45	0.43	70/160	–	4.5	120
	T-U	2G13	370	L18.933	534624	220,50	150	140	45	0.43	70/160	–	4.5	120
2x18	TC-F/TC-L	2G10/2G11	400	L36.158	530252	220,50	150	140	45	0.43	65	–	4.0	210
24	TC-F/TC-L	2G10/2G11	345	L18.933	534624	220,50	150	140	45	0.43	70/160	–	4.5	150
26	TC-D/TC-T	G24d-3/GX24d-3	325	L18.933	534624	220,50	150	140	45	0.43	70/160	–	3.5	140
28	TC-DD	GR8/GR10q	320	L18.933	534624	220,50	150	140	45	0.43	70/160	–	3.5	150
36	TC-F/TC-L	2G10/2G11	430	L36.158	530252	220,50	150	140	45	0.43	65	–	4.5	210
36/40	T-U/T-R	2G13/G10q	430	L36.158	530252	220,50	150	140	45	0.43	65	–	4.5	210
38	TC-DD	GR10q	430	L36.158	530252	220,50	150	140	45	0.43	65	–	4.5	210
58	T-U	2G13	670	L58.625	164828	220,50	190	180	92	0.80	55/155	–	7.0	320
220 V, 60 Hz														
18	TC-D/TC-T	G24d-2/GX24d-2	220	L18.602	164779	220,60	85	75	34	0.32	45/110	–	2.0	110
	TC-F/TC-L	2G10/2G11	370	L18.121	532149	220,60	110	100	45	0.42	65/145	–	4.0	150
				L18.121	528582	220,60	150	140	45	0.43	65/145	–	4.0	150
				L18.249	538801	220,60	150	140	34	0.32	75/140	–	4.0	150
	T-U	2G13	370	L18.121	532149	220,60	110	100	45	0.42	65/145	–	4.0	150
				L18.121	528582	220,60	150	140	45	0.43	65/145	–	4.0	150
L18.249				538801	220,60	150	140	34	0.32	75/140	–	4.0	150	
2x18	TC-F/TC-L	2G10/2G11	400	L36.120	509373	220,60	150	140	45	0.43	60/170	–	4.0	210
24	TC-F/TC-L	2G10/2G11	345	L18.121	532149	220,60	110	100	45	0.42	65/145	–	4.0	190
				L18.121	528582	220,60	150	140	45	0.43	65/145	–	4.0	190
				L18.249	538801	220,60	150	140	34	0.32	75/140	–	4.0	190
26	TC-D/TC-T	G24d-3/GX24d-3	325	L18.121	532149	220,60	110	100	45	0.42	65/145	–	3.0	160
				L18.121	528582	220,60	150	140	45	0.43	65/145	–	3.0	160
				L18.249	538801	220,60	150	140	34	0.32	75/140	–	3.0	160
28	TC-DD	GR8/GR10q	320	L18.121	532149	220,60	110	100	45	0.42	65/145	–	3.0	155
				L18.249	538801	220,60	150	140	34	0.32	75/140	–	3.0	155
36	TC-F/TC-L	2G10/2G11	430	L36.120	509373	220,60	150	140	45	0.43	60/170	–	4.0	210
36/40	T-U/T-R	2G13/G10q	430	L36.120	509373	220,60	150	140	45	0.43	60/170	–	4.0	220
38	TC-DD	GR10q	430	L36.120	509373	220,60	150	140	45	0.43	60/170	–	4.0	220
58	T-U	2G13	670	L58.657	164870	220,60	195	180	92	0.80	55/140	–	6.0	320

* Energy efficiency: EEI=B2 and EEI=B1, valid until 2017

1

2

3

4

5

6

7

8

9

10

Ballasts 5–20 W 120 V/60 Hz

For compact fluorescent lamps
Shape: 28 x 41 mm

Vacuum-impregnated with polyester resin

Push-in terminal for leads: 0.5–1 mm²

For the automatic luminaire wiring:

IDC terminals for leads HO5V-U 0.5

tw 130

Protection class I

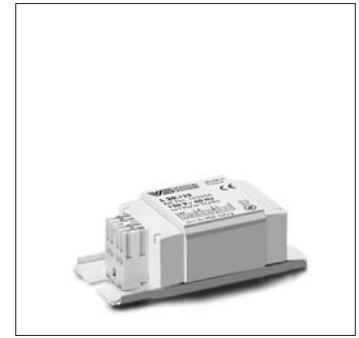
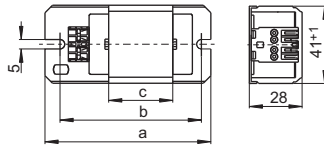

Lamp				Ballast								Capacitor	
Output	Type	Base	Current	Type	Ref. No.	Voltage	a	b	c	Weight	$\Delta t / \Delta t_{an}$	C _p	Current
W			mA			V, Hz	mm	mm	mm	kg	K	μ F	mA
120 V, 60 Hz													
5	TC-S	G23	180	L7/9.209	163318	120, 60	85	75	34	0.32	25/40	3.0	90
7	TC-S	G23	175	L7/9.209	163318	120, 60	85	75	34	0.32	25/40	3.0	90
9	TC-S	G23	170	L7/9.209	163318	120, 60	85	75	34	0.32	25/40	3.0	90
18	TC-F/TC-L	2G10/2G11	370	L20.122	163256	120, 60	85	75	34	0.32	35/80	5.0	150
20	T-U	2G13	370	L20.122	163256	120, 60	85	75	34	0.32	35/80	5.0	190

Super Low-loss Ballasts 18–65 W, 230 V

For fluorescent lamps

Shape: 28 x 41 mm / 53 x 66 mm

Vacuum-impregnated with polyester resin

Push-in terminal for leads: 0.5–1 mm²

tw 130

Protection class I

**Energy efficiency: A2,
minimum EU energy efficiency
requirements as of 2017**



A 53x66 mm

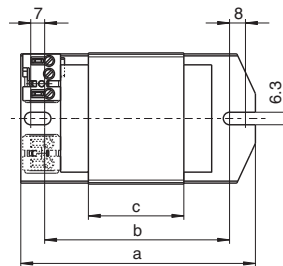

B 28x41 mm

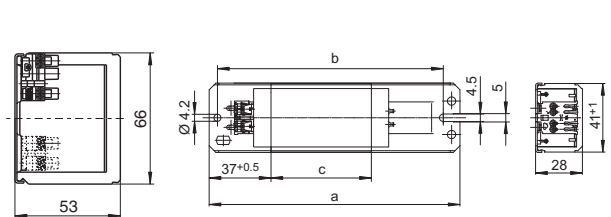

Lamp				Ballast										Capacitor	
Output	Type	Base	Current	Type	Ref. No.	Voltage	Draw- ing	a	b	c	Weight	$\Delta t/\Delta t_{an}$	Energy efficiency*	C _p	Current
W			mA			V, Hz		mm	mm	mm	kg	K		µF	mA
230 V, 50 Hz															
18/20	T8 (T26)/T12 (T38)	G13	370	LNN 18.645	560657	230, 50	A	130	105	64	1.80	10/20	A2	4.5	120
2x18/20	T8 (T26)/T12 (T38)	G13	400	LNN 36.646	560659	230, 50	A	108	90	36	1.10	25/70	A2	4.0	210
				LNN 36.648	560664	230, 50	B	232.5	220	160	1.35	25/40	A2	4.5	210
36/40	T8 (T26)/T12 (T38)	G13	430	LNN 36.646	560659	230, 50	A	108	90	36	1.10	25/70	A2	4.0	120
				LNN 36.648	560664	230, 50	B	232.5	220	160	1.35	25/40	A2	4.5	210
58/65	T8 (T26)/T12 (T38)	G13	670	LNN 58.647	560661	230, 50	A	108	90	36	1.10	30/110	A2	7.0	320
				LNN 58TD.649**	560665	230, 50	B	232.5	220	160	1.35	20/40	A2	7.0	320

* Energy efficiency: A2, minimum EU energy efficiency requirements as of 2017

** TD = halfchoke (two ballasts per lamp are necessary)

1

2

3

4

5

6

7

8

9

10

Standard Ballasts

4-13 W

230/240/220 V

For fluorescent lamps

Shape: 28 x 41 mm

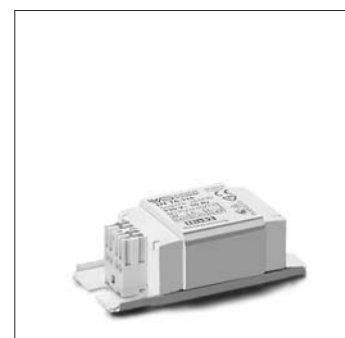
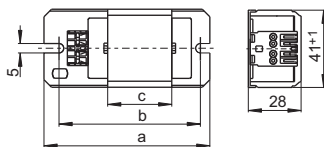

Vacuum-impregnated with polyester resin

Push-in terminal for leads: 0.5-1 mm²

For the automatic luminaire wiring:

IDC terminals for leads HO5V-U 0.5

tw 130

Protection class I

Lamp				Ballast									Capacitor	
Output	Type	Base	Current	Type	Ref. No.	Voltage	a	b	c	Weight	$\Delta t/\Delta t_{on}$	Energy efficiency*	C _p	Current
W			mA			V, Hz	mm	mm	mm	kg	K		μF	mA
230 V, 50 Hz														
4	T5 (T16)	G5	170	L4/6/8.304	163683	230, 50	85	75	34	0.32	55/85	B2	2.0	40
2x4	T5 (T16)	G5	155	L4/6/8.304	163683	230, 50	85	75	34	0.32	55/85	B1	2.0	50
6	T5 (T16)	G5	160	L4/6/8.304	163683	230, 50	85	75	34	0.32	55/85	B1	2.0	50
2x6	T5 (T16)	G5	175	LN 13.313	163711	230, 50	85	75	34	0.32	55/80	B1	2.0	65
8	T5 (T16)	G5	145	L4/6/8.304	163683	230, 50	85	75	34	0.32	55/85	B1	2.0	60
2x8	T5 (T16)	G5	155	LN 13.313	163711	230, 50	85	75	34	0.32	55/80	B1	2.0	85
13	T5 (T16)	G5	165	LN 13.313	163711	230, 50	85	75	34	0.32	55/80	B1	2.0	80
240 V, 50 Hz														
4	T5 (T16)	G5	170	L4/6/8.404	164326	240, 50	85	75	34	0.32	55/80	B2	2.0	40
2x4	T5 (T16)	G5	155	L4/6/8.404	164326	240, 50	85	75	34	0.32	55/80	B1	2.0	50
6	T5 (T16)	G5	160	L4/6/8.404	164326	240, 50	85	75	34	0.32	55/80	B1	2.0	50
2x6	T5 (T16)	G5	175	LN 13.413	164342	240, 50	85	75	34	0.32	60/90	B1	2.0	65
8	T5 (T16)	G5	145	L4/6/8.404	164326	240, 50	85	75	34	0.32	55/80	B1	2.0	60
2x8	T5 (T16)	G5	155	LN 13.413	164342	240, 50	85	75	34	0.32	60/90	B1	2.0	85
13	T5 (T16)	G5	165	LN 13.413	164342	240, 50	85	75	34	0.32	60/90	B1	2.0	80
220 V, 60 Hz														
4	T5 (T16)	G5	170	L4/6/8.218	532644	220, 60	85	75	34	0.32	60/80	–	2.0	40
2x4	T5 (T16)	G5	155	L4/6/8.218	532644	220, 60	85	75	34	0.32	60/80	–	2.0	50
6	T5 (T16)	G5	160	L4/6/8.218	532644	220, 60	85	75	34	0.32	60/80	–	2.0	50
2x6	T5 (T16)	G5	175	L13.210	520992	220, 60	85	75	34	0.32	45/80	–	2.0	65
8	T5 (T16)	G5	145	L4/6/8.218	532644	220, 60	85	75	34	0.32	60/80	–	2.0	60
2x8	T5 (T16)	G5	155	L13.210	520992	220, 60	85	75	34	0.32	45/80	–	2.0	85
13	T5 (T16)	G5	165	L13.210	520992	220, 60	85	75	34	0.32	45/80	–	2.0	80

* Energy efficiency: EEI=B2 and EEI=B1, valid until 2017

Standard Ballasts 14–65 W, 230 V

For fluorescent lamps

Shape: 28 x 41 mm

Vacuum-impregnated with polyester resin

Push-in terminal for leads: 0.5–1 mm²

For the automatic luminaire wiring:

IDC terminals for leads HO5V-U 0.5

tw 130

Protection class I

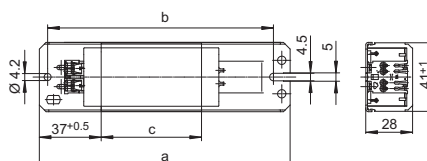

Lamp				Ballast									Capacitor	
Output W	Type	Base	Current mA	Type	Ref. No.	Voltage V, Hz	a mm	b mm	c mm	Weight kg	$\Delta t/\Delta t_{an}$ K	Energy efficiency*	C _p μF	Current mA
230 V, 50 Hz														
14	T8 (T26)	G13	395	LN 18.510	164572	230, 50	155	140	92	0.80	40/65	B2	4.5	150
15	T8 (T26)	G13	310	LN 15.329	163861	230, 50	150	140	60	0.55	50/80	B2	3.5	120
2x15	T8 (T26)	G13	340	LN 30.801	169645	230, 50	150	140	60	0.55	55/110	B2	4.0	185
				L 30.347**	164033	230, 50	150	140	60	0.55	60/150	–	4.0	185
16	T8 (T26)	G13	200	LN 16.316	163730	230, 50	85	75	34	0.32	60/125	B1	2.0	90
18/20	T8 (T26)/T12 (T38)	G13	370	LN 18.510	164572	230, 50	155	140	92	0.80	40/65	B1	4.5	120
				LN 18.131	530941	230, 50	150	140	60	0.55	55/95	B2	4.5	120
				L 18.934**	534621	230, 50	150	140	45	0.43	70/150	–	4.5	120
2x18/20	T8 (T26)/T12 (T38)	G13	400	LN 2x18.135	532155	230, 50	150	140	45	0.43	65	B1	4.0	210
25	T12 (T38)	G13	290	L 25.346	164013	230, 50	150	140	60	0.55	45/80	B1	3.5	130
30	T8 (T26)	G13	365	LN 30.801	169645	230, 50	150	140	60	0.55	55/110	B2	4.5	180
36-1	T8 (T26)	G13	556	L 36.1342	538072	230, 50	195	180	110	0.87	50/120	B2	6.5	250
36/40	T8 (T26)/T12 (T38)	G13	430	LN 36.570	169779	230, 50	155	140	92	0.80	35/90	B1	4.5	210
				LN 36.511	164590	230, 50	155	140	92	0.80	35/95	B1	4.5	210
				LN 36.130	527191	230, 50	150	140	60	0.55	50/140	B2	4.5	210
				LN 36.149	529029	230, 50	150	140	60	0.55	55/150	B2	4.5	210
				L 36.132**	535977	230, 50	150	140	45	0.43	65	–	4.5	210
38	T8 (T26)	G13	430	LN 36.570	169779	230, 50	155	140	92	0.80	35/90	B1	4.5	210
				LN 36.511	164590	230, 50	155	140	92	0.80	35/95	B1	4.5	210
				LN 36.149	529029	230, 50	150	140	60	0.55	55/150	B2	4.5	210
				L 36.132**	535977	230, 50	150	140	45	0.43	65	–	4.5	210
58/65	T8 (T26)/T12 (T38)	G13	670	LN 58.568	169389	230, 50	233	220	160	1.31	35/95	B1	7.0	320
				LN 58.990	509349	230, 50	190	180	110	0.95	50/130	B2	7.0	320
				LN 58.116	508186	230, 50	190	180	92	0.80	55/160	B2	7.0	320
				L 58.718**	169658	230, 50	190	180	92	0.80	60/170	–	7.0	320

* Energy efficiency: EEI=B2 and EEI=B1, valid until 2017

** Ballasts without CE mark for markets outside of the EU

Standard Ballasts 15–75 W, 240/220 V

For fluorescent lamps

Shape: 28 x 41 mm

Lamp				Ballast									Capacitor	
Output	Type	Base	Current	Type	Ref. No.	Voltage	a	b	c	Weight	$\Delta t/\Delta t_{an}$	Energy efficiency*	C _p	Current
W			mA			V, Hz	mm	mm	mm	kg	K		μF	mA
240 V, 50 Hz														
2x15	T8 (T26)	G13	340	LN 30.806	533067	240, 50	150	140	60	0.55	55/130	B2	4.0	185
16	T8 (T26)	G13	200	LN 16.417	164358	240, 50	85	75	34	0.32	60/130	B1	2.0	90
18/20	T8 (T26)/T12 (T38)	G13	370	LN 18.507	164566	240, 50	155	140	92	0.80	35/60	B1	4.5	120
				LN 18.162	533043	240, 50	150	140	60	0.55	60/110	B2	4.5	120
				L 18.936**	534627	240, 50	150	140	45	0.43	70/140	–	4.5	120
2x18/20	T8 (T26)/T12 (T38)	G13	400	LN 2x18.135	535778	240, 50	150	140	45	0.43	65	B1	4.0	210
				LN 36.201	527196	240, 50	150	140	60	0.55	55/140	B1	4.0	210
				LN 36.505	164555	240, 50	155	140	92	0.80	40/95	B1	4.0	210
30	T8 (T26)	G13	365	LN 30.806	533067	240, 50	150	140	60	0.55	55/130	B2	4.5	180
36/40	T8 (T26)/T12 (T38)	G13	430	LN 36.505	164555	240, 50	155	140	92	0.80	40/95	B1	4.5	210
				LN 36.201	527196	240, 50	150	140	60	0.55	55/140	B2	4.5	210
				L 36/40.443**	164438	240, 50	150	140	60	0.55	65/155	–	4.5	210
38	T8 (T26)	G13	430	LN 36.505	164555	240, 50	155	140	92	0.80	40/95	B1	4.5	210
				LN 36.201	527196	240, 50	150	140	60	0.55	55/140	B2	4.5	210
				L 36/40.443**	164438	240, 50	150	140	60	0.55	65/155	–	4.5	210
58/65	T8 (T26)/T12 (T38)	G13	670	LN 58.506	164560	240, 50	233	220	160	1.31	35/85	B1	7.0	320
				LN 58.192	507936	240, 50	190	180	110	0.95	50/150	B2	7.0	320
				LN 58.722	534252	240, 50	190	180	92	0.80	60/180	B2	7.0	320
70/75	T8 (T26)/T12 (T38)	G13	670	LN 75.170	533650	240, 50	190	180	110	0.95	50/150	B2	6.0	320
220 V, 50 Hz														
18/20	T8 (T26)/T12 (T38)	G13	370	L 18.933	534624	220, 50	150	140	45	0.43	70/160	–	4.5	120
2x18/20	T8 (T26)/T12 (T38)	G13	430	L 36.158	530252	220, 50	150	140	45	0.43	65	–	4.0	210
36/40	T8 (T26)/T12 (T38)	G13	430	L 36.158	530252	220, 50	150	140	45	0.43	65	–	4.5	210
38	T8 (T26)	G13	430	L 36.158	530252	220, 50	150	140	45	0.43	65	–	4.5	210
58/65	T8 (T26)/T12 (T38)	G13	670	L 58.625	164828	220, 50	190	180	92	0.80	55/155	–	7.0	320
220 V, 60 Hz														
15	T8 (T26)	G13	310	L 15.007	537744	220, 60	150	140	45	0.43	55/80	–	3.0	120
2x15	T8 (T26)	G13	350	L 30.006	537750	220, 60	150	140	45	0.43	60/120	–	4.0	185
18/20	T8 (T26)/T12 (T38)	G13	370	L 18.121	532149	220, 60	110	100	45	0.42	65/145	–	4.0	190
				L 18.121	528582	220, 60	150	140	45	0.43	65/145	–	4.0	190
				L 18.149	538801	220, 60	150	140	34	0.32	75/140	–	4.0	190
2x18/20	T8 (T26)/T12 (T38)	G13	430	L 36.120	509373	220, 60	150	140	45	0.43	60/170	–	4.0	220
30	T8 (T26)	G13	365	L 30.006	537750	220, 60	150	140	45	0.43	60/120	–	4.0	180
36/40	T8 (T26)/T12 (T38)	G13	430	L 36.120	509373	220, 60	150	140	45	0.43	60/170	–	4.0	220
38	T8 (T26)	G13	430	L 36.120	509373	220, 60	150	140	45	0.43	60/170	–	4.0	230
58/65	T8 (T26)/T12 (T38)	G13	670	L 58.657	164870	220, 60	195	180	92	0.80	55/140	–	6.0	320

* Energy efficiency: EEI=B2 and EEI=B1, valid until 2017

** Ballasts without CE mark for markets outside of the EU

Ballasts 14-20 W 120 V/60 Hz

For fluorescent lamps
Shape: 28 x 41 mm

Vacuum-impregnated with polyester resin
Push-in terminal for leads: 0.5-1 mm²
For the automatic luminaire wiring:
IDC terminals for leads HO5V-U 0.5
tw 130
Protection class I

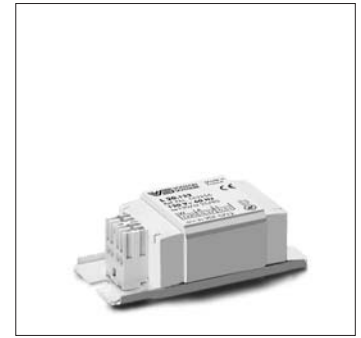
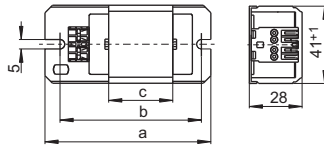

1

2

3

4

5

6

7

8

9

10

Lamp				Ballast								Capacitor	
Output	Type	Base	Current	Type	Ref. No.	Voltage	a	b	c	Weight	$\Delta t / \Delta t_{an}$	C _p	Current
W			mA			V, Hz	mm	mm	mm	kg	K	μF	mA
120 V, 60 Hz													
14	T8 (T26)	G13	395	L 14.139	170117	120, 60	85	75	34	0.32	55/90	7.0	175
15	T8 (T26)	G13	350	L 15.308	163702	120, 60	85	75	34	0.32	35/65	7.0	170
18/20	T8 (T26)/T12 (T38)	G13	370	L 20.122	163256	120, 60	85	75	34	0.32	35/80	5.0	190

COMPACT AND VERSATILE



VS LAMPHOLDERS FOR COMPACT FLUORESCENT LAMPS

Vossloh-Schwabe provides a broad range of lampholders for single-ended compact fluorescent lamps, with regard to which the numerous fixing methods make just about any luminaire design possible.

As compact fluorescent lamps generate considerably less heat in comparison to incandescent lamps, the advantages provided by thermoplastics can be fully utilized for lampholder design.

Almost all VS lampholders for compact fluorescent lamps are made of thermoplastic PBT and therefore bear the T marking T140, which refers to the maximum base temperature in accordance with EN 61199 (VDE 0715 T9). The use of this highly heat-resistant material was born of close cooperation between Vossloh-Schwabe and the world's leading lamp manufacturers that also use PBT for producing lamp bases. In connection with fatigue-resistant, stainless steel lamp mounting springs, harmonizing the casing material ensures a permanent and secure lamp fit.



3

Lampholders and Accessories for TC Lamps

G24, GX24 lampholders	166–171
2G7 lampholders	172
G23 lampholders	173–175
GR8, GR10q, GRY10q-3, GRZ10d, GRZ10t lampholders	175–176
2G10 lampholders	176
2G11/2GX11 lampholders	177–178
Accessories	179–181
GX53-1 lampholders, accessories	182
Technical details for fluorescent lamps	226–253
General technical details	366–374
Glossary	375–377

1

2

3

4

5

6

7

8

9

10

G24, GX24 Lampholders

For single-ended compact fluorescent lamps TC-D, TC-T, TC-DEL, TC-TEL

The drawings and photos contained in this chapter only show lampholders for lamps with base G24q-1. Further drawings of lamp bases can be found on page 248.

When mounting the lampholder it has to be considered that the TC-T and TC-TEL lamp is wider than the lampholder. When using the central hole for mounting additional depressions for anti-rotation pips have to be provided.

G24, GX24 lampholders

Plain casing

Casing: PBT GF, white, T140

Nominal rating: 2/500

Push-in twin terminals: 0.5-1 mm² (lamp circuit)

In addition for G24q, GX24q lampholders:

push-in terminals: 0.5-1 mm² (starter circuit)

Rear fixing holes for self-lapping screws

acc. to ISO 1481/7049-ST4.2-C/F

Front fixing holes for screws M3

Central fixing hole for screw M3

Rotation stop

For cover caps (see p. 310-312)

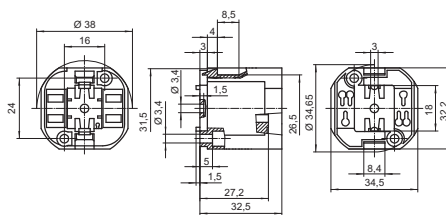

Type	Ref. No.	Base	Lamp	Output (W)	Weight (g)	Unit (pcs.)
71501	527735	G24d-1/GX24d-1	TC-D/TC-T	10, 13 / 13	13	500
71502	527736	G24d-2/GX24d-2	TC-D/TC-T	18 / 18	13	500
71503	527737	G24d-3/GX24d-3	TC-D/TC-T	26 / 26	13	500
71511	527739	G24q-1/GX24q-1	TC-DEL/TC-TEL	10, 13 / 13	14.5	500
71512	527740	G24q-2/GX24q-2	TC-DEL/TC-TEL	18 / 18	14.5	500
71513	527741	G24q-3/GX24q-3	TC-DEL/TC-TEL	26 / 26, 32	14.5	500
71519	527745	GX24q-3/-4*	TC-TEL	26, 32 / 42	14.5	500
71514	527742	GX24q-4	TC-TEL	42	14.5	500
71515	527743	GX24q-5	TC-TEL	57	15.1	500
71516	527744	GX24q-6	TC-TEL	70	15.1	500

* Lampholder 527745 may only be used in luminaires that are operated with electronic ballasts that have been certified according to the applicable standards and that cover the luminaire performance range of 26, 32 and 42 W.

Lampholders and Accessories for TC Lamps

G24, GX24 lampholders

External thread 40x2.5 IEC 60399

Casing: PBT GF, white, T140

Nominal rating: 2/500

Push-in twin terminals: 0.5-1 mm² (lamp circuit)

In addition for G24q, GX24q lampholders:

push-in terminals: 0.5-1 mm² (starter circuit)

Rear fixing holes for self-tapping screws

acc. to ISO 1481/7049-ST4.2-C/F

Front fixing holes for screws M3

Central fixing hole for screw M3

Rotation stop

For cover caps (see p. 310-312)

For screw rings (see p. 326)

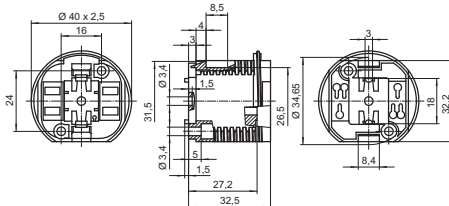

1

2

3

Type	Ref. No.	Base	Lamp	Output (W)	Weight (g)	Unit (pcs.)
71001	527502	G24d-1/GX24d-1	TC-D/TC-T	10, 13 / 13	12.7	500
71002	527503	G24d-2/GX24d-2	TC-D/TC-T	18 / 18	12.7	500
71003	527504	G24d-3/GX24d-3	TC-D/TC-T	26 / 26	12.7	500
71011	527506	G24q-1/GX24q-1	TC-DEL/TC-TEL	10, 13 / 13	15.2	500
71012	527507	G24q-2/GX24q-2	TC-DEL/TC-TEL	18 / 18	15.2	500
71013	527508	G24q-3/GX24q-3	TC-DEL/TC-TEL	26 / 26, 32	15.2	500
71019	527512	GX24q-3/-4*	TC-TEL	26, 32 / 42	15.2	500
71014	527509	GX24q-4	TC-TEL	42	15.2	500
71015	527510	GX24q-5	TC-TEL	57	15.8	500
71016	527511	GX24q-6	TC-TEL	70	15.8	500

* Lampholder 527512 may only be used in luminaires that are operated with electronic ballasts that have been certified according to the applicable standards and that cover the luminaire performance range of 26, 32 and 42 W.

4

5

G24, GX24 lampholders

Profiled shape

Casing: PBT GF, white, T140

Nominal rating: 2/500

Push-in twin terminals: 0.5-1 mm² (lamp circuit)

In addition for G24q, GX24q lampholders:

push-in terminals: 0.5-1 mm² (starter circuit)

Central fixing hole for screw M3

Rotation stop

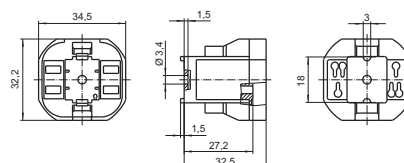

6

7

8

Type	Ref. No.	Base	Lamp	Output (W)	Weight (g)	Unit (pcs.)
71101	527529	G24d-1/GX24d-1	TC-D/TC-T	10, 13 / 13	8.5	500
71102	527530	G24d-2/GX24d-2	TC-D/TC-T	18 / 18	8.5	500
71103	527531	G24d-3/GX24d-3	TC-D/TC-T	26 / 26	8.5	500
71111	527533	G24q-1/GX24q-1	TC-DEL/TC-TEL	10, 13 / 13	10.9	500
71112	527534	G24q-2/GX24q-2	TC-DEL/TC-TEL	18 / 18	10.9	500
71113	527535	G24q-3/GX24q-3	TC-DEL/TC-TEL	26 / 26, 32	10.9	500
71119	527539	GX24q-3/-4*	TC-TEL	26, 32 / 42	10.9	500
71114	527536	GX24q-4	TC-TEL	42	10.9	500
71115	527537	GX24q-5	TC-TEL	57	11.1	500
71116	527538	GX24q-6	TC-TEL	70	11.1	500

* Lampholder 527539 may only be used in luminaires that are operated with electronic ballasts that have been certified according to the applicable standards and that cover the luminaire performance range of 26, 32 and 42 W.

9

10

Lampholders and Accessories for TC Lamps

G24, GX24 push-fit lampholders

Lamp position: 45°

Casing: PBT GF, white, T140

Nominal rating: 2/500

Push-in twin terminals: 0.5-1 mm² (lamp circuit)

In addition for G24q, GX24q lampholders:

push-in terminals: 0.5-1 mm² (starter circuit)

Push-fit foot for cut-out 10x20 mm

for wall thickness 0.6-1 mm

Foot with facility for cable routing

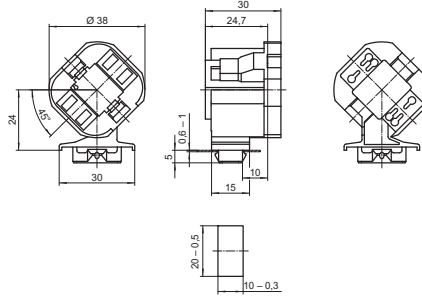

Type	Ref. No.	Base	Lamp	Output (W)	Weight (g)	Unit (pcs.)
71301	527585	G24d-1/GX24d-1	TC-D/TC-T	10, 13 / 13	10.2	500
71302	527586	G24d-2/GX24d-2	TC-D/TC-T	18 / 18	10.2	500
71303	527587	G24d-3/GX24d-3	TC-D/TC-T	26 / 26	10.2	500
71311	527589	G24q-1/GX24q-1	TC-DEL/TC-TEL	10, 13 / 13	12.1	500
71312	527590	G24q-2/GX24q-2	TC-DEL/TC-TEL	18 / 18	12.1	500
71313	527591	G24q-3/GX24q-3	TC-DEL/TC-TEL	26 / 26, 32	12.1	500
71319	527596	GX24q-3/-4*	TC-TEL	26, 32 / 42	12.1	500
71314	527592	GX24q-4	TC-TEL	42	12.1	500
71315	527594	GX24q-5	TC-TEL	57	12.6	500
71316	527595	GX24q-6	TC-TEL	70	12.6	500

* Lampholder 527596 may only be used in luminaires that are operated with electronic ballasts that have been certified according to the applicable standards and that cover the luminaire performance range of 26, 32 and 42 W.

G24 push-fit lampholders

Lamp position: 45°

Casing: PBT GF, white, T140

Nominal rating: 2/500

Push-in twin terminals: 0.5-1 mm² (lamp circuit)

In addition for G24q lampholders:

push-in terminals: 0.5-1 mm² (starter circuit)

Split pins for wall thickness up to 1.2 mm

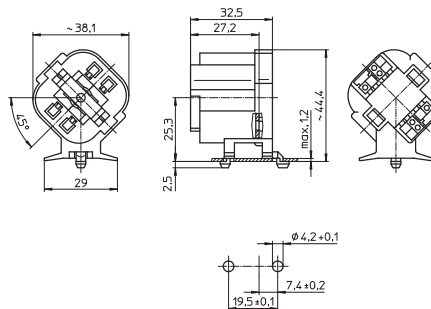

Type	Ref. No.	Base	Lamp	Output (W)	Weight (g)	Unit (pcs.)
35814	106893	G24d-1	TC-D	10, 13	14.3	500
35844	107617	G24d-2	TC-D	18	14.3	500
35864	107618	G24d-3	TC-D	26	14.3	500
35914	107861	G24q-1	TC-DEL	10, 13	15	500
35944	108575	G24q-2	TC-DEL	18	15	500
35964	108576	G24q-3	TC-DEL	26	15	500

Lampholders and Accessories for TC Lamps

G24, GX24 push-fit lampholders

Casing: PBT GF, white, T140

Nominal rating: 2/500

Push-in twin terminals: 0.5-1 mm² (lamp circuit)

In addition for G24q, GX24q lampholders:

push-in terminals: 0.5-1 mm² (starter circuit)

Push-fit foot for cut-out 10x20 mm

for wall thickness 0.6-1 mm

Foot with facility for cable routing

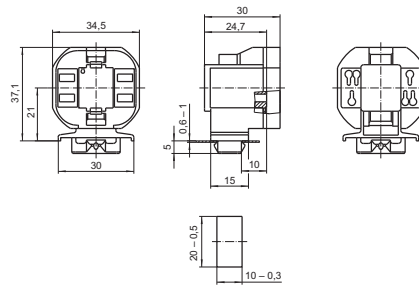

1

2

3

4

5

6

7

8

9

10

Type	Ref. No.	Base	Lamp	Output (W)	Weight (g)	Unit (pcs.)
71801	528029	G24d-1/GX24d-1	TC-D/TC-T	10, 13 / 13	10.2	500
71802	528030	G24d-2/GX24d-2	TC-D/TC-T	18 / 18	10.2	500
71803	528031	G24d-3/GX24d-3	TC-D/TC-T	26 / 26	10.2	500
71811	528033	G24q-1/GX24q-1	TC-DEL/TC-TEL	10, 13 / 13	12.1	500
71812	528034	G24q-2/GX24q-2	TC-DEL/TC-TEL	18 / 18	12.1	500
71813	528035	G24q-3/GX24q-3	TC-DEL/TC-TEL	26 / 26, 32	12.1	500
71819	528039	GX24q-3/-4*	TC-TEL	26, 32 / 42	12.1	500
71814	528036	GX24q-4	TC-TEL	42	12.1	500
71815	528037	GX24q-5	TC-TEL	57	12.7	500
71816	528038	GX24q-6	TC-TEL	70	12.7	500

* Lampholder 528039 may only be used in luminaires that are operated with electronic ballasts that have been certified according to the applicable standards and that cover the luminaire performance range of 26, 32 and 42 W.

G24, GX24 surface-mounted lampholders

Casing: PBT GF, white, T140, Nominal rating: 2/500

Push-in twin terminals: 0.5-1 mm² (lamp circuit)

In addition for G24q, GX24q lampholders:

push-in terminals: 0.5-1 mm² (starter circuit)

Base fixing holes for self-tapping screws

acc. to ISO 1481/7049-ST4.2-C/F

Base oblong holes for screws M4

Rear fixing holes for self-tapping screws

acc. to ISO 1481/7049-ST2.9-C/F

and ST4.2-C/F

Front fixing holes for screws M3

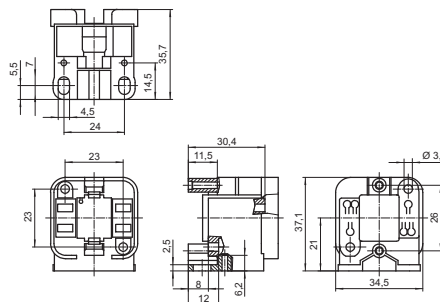

Type	Ref. No.	Base	Lamp	Output (W)	Weight (g)	Unit (pcs.)
71701	527790	G24d-1/GX24d-1	TC-D/TC-T	10, 13 / 13	13.2	500
71702	527791	G24d-2/GX24d-2	TC-D/TC-T	18 / 18	13.2	500
71703	527792	G24d-3/GX24d-3	TC-D/TC-T	26 / 26	13.2	500
71711	527794	G24q-1/GX24q-1	TC-DEL/TC-TEL	10, 13 / 13	15.2	500
71712	527795	G24q-2/GX24q-2	TC-DEL/TC-TEL	18 / 18	15.2	500
71713	527796	G24q-3/GX24q-3	TC-DEL/TC-TEL	26 / 26, 32	15.2	500
71719	527800	GX24q-3/-4*	TC-TEL	26, 32 / 42	15.2	500
71714	527797	GX24q-4	TC-TEL	42	15.2	500
71715	527798	GX24q-5	TC-TEL	57	15.8	500
71716	527799	GX24q-6	TC-TEL	70	15.8	500

* Lampholder 527800 may only be used in luminaires that are operated with electronic ballasts that have been certified according to the applicable standards and that cover the luminaire performance range of 26, 32 and 42 W.

Lampholders and Accessories for TC Lamps

G24, GX24 surface-mounted lampholders

Casing: PBT GF, white, T140

Nominal rating: 2/500

Push-in twin terminals: 0.5-1 mm² (lamp circuit)

In addition for G24q, GX24q lampholders:

push-in terminals: 0.5-1 mm² (starter circuit)

Front fixing holes for screws M3

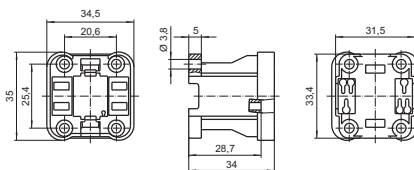

Type	Ref. No.	Base	Lamp	Output (W)	Weight (g)	Unit (pcs.)
71201	527556	G24d-1/GX24d-1	TC-D/TC-T	10, 13 / 13	12	500
71202	527557	G24d-2/GX24d-2	TC-D/TC-T	18 / 18	12	500
71203	527558	G24d-3/GX24d-3	TC-D/TC-T	26 / 26	12	500
71211	527560	G24q-1/GX24q-1	TC-DEL/TC-TEL	10, 13 / 13	12.9	500
71212	527561	G24q-2/GX24q-2	TC-DEL/TC-TEL	18 / 18	12.9	500
71213	527562	G24q-3/GX24q-3	TC-DEL/TC-TEL	26 / 26, 32	12.9	500
71219	527566	GX24q-3/-4*	TC-TEL	26, 32 / 42	12.9	500
71214	527563	GX24q-4	TC-TEL	42	12.9	500
71215	527564	GX24q-5	TC-TEL	57	13.5	500
71216	527565	GX24q-6	TC-TEL	70	13.5	500

* Lampholder 527566 may only be used in luminaires that are operated with electronic ballasts that have been certified according to the applicable standards and that cover the luminaire performance range of 26, 32 and 42 W.

G24, GX24 push-fit lampholders

Casing: PBT GF, white, T140

Nominal rating: 2/500

Push-in twin terminals: 0.5-1 mm² (lamp circuit)

In addition for G24q, GX24q lampholders:

push-in terminals: 0.5-1 mm² (starter circuit)

Base split pins for wall thickness 0.8-1.7 mm

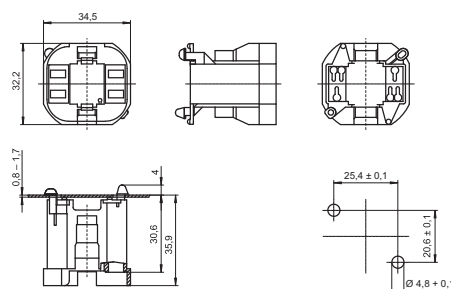

Type	Ref. No.	Base	Lamp	Output (W)	Weight (g)	Unit (pcs.)
71601	527762	G24d-1/GX24d-1	TC-D/TC-T	10, 13 / 13	10.5	500
71602	527763	G24d-2/GX24d-2	TC-D/TC-T	18 / 18	10.5	500
71603	527764	G24d-3/GX24d-3	TC-D/TC-T	26 / 26	10.5	500
71611	527766	G24q-1/GX24q-1	TC-DEL/TC-TEL	10, 13 / 13	12	500
71612	527768	G24q-2/GX24q-2	TC-DEL/TC-TEL	18 / 18	12	500
71613	527769	G24q-3/GX24q-3	TC-DEL/TC-TEL	26 / 26, 32	12	500
71619	527773	GX24q-3/-4*	TC-TEL	26, 32 / 42	12	500
71614	527770	GX24q-4	TC-TEL	42	12	500
71615	527771	GX24q-5	TC-TEL	57	12.6	500
71616	527772	GX24q-6	TC-TEL	70	12.6	500

* Lampholder 527773 may only be used in luminaires that are operated with electronic ballasts that have been certified according to the applicable standards and that cover the luminaire performance range of 26, 32 and 42W.

Lampholders and Accessories for TC Lamps

G24, GX24 push-fit lampholders

Casing: PBT GF, white, T140

Nominal rating: 2/500

Push-in twin terminals: 0.5-1 mm² (lamp circuit)

In addition for G24q, GX24q lampholders:

push-in terminals: 0.5-1 mm² (starter circuit)

Rear split pins for wall thickness 0.8-1.7 mm

Width of split pin: 4.5 mm

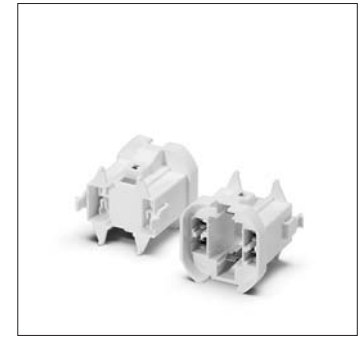
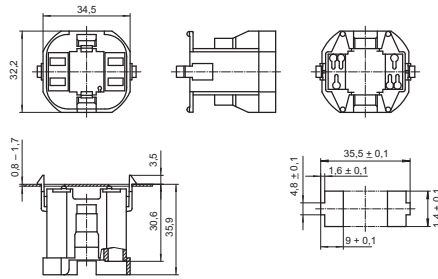

Type	Ref. No.	Base	Lamp	Output (W)	Weight (g)	Unit (pcs.)
72101	528116	G24d-1/GX24d-1	TC-D/TC-T	10, 13 / 13	10.4	500
72102	528117	G24d-2/GX24d-2	TC-D/TC-T	18 / 18	10.4	500
72103	528118	G24d-3/GX24d-3	TC-D/TC-T	26 / 26	10.4	500
72111	528120	G24q-1/GX24q-1	TC-DEL/TC-TEL	10, 13 / 13	12.3	500
72112	528121	G24q-2/GX24q-2	TC-DEL/TC-TEL	18 / 18	12.3	500
72113	528122	G24q-3/GX24q-3	TC-DEL/TC-TEL	26 / 26, 32	12.3	500
72119	528126	GX24q-3/-4*	TC-TEL	26, 32 / 42	12.3	500
72114	528123	GX24q-4	TC-TEL	42	12.3	500
72115	528124	GX24q-5	TC-TEL	57	12.9	500
72116	528125	GX24q-6	TC-TEL	70	12.9	500

* Lampholder 528126 may only be used in luminaires that are operated with electronic ballasts that have been certified according to the applicable standards and that cover the luminaire performance range of 26, 32 and 42 W.

1

2

3

4

5

6

7

8

9

10

2G7 Lampholders

For single-ended compact fluorescent lamps TC-SEL

2G7 push-fit lampholder

Casing: PBT GF, white, T140, nominal rating: 2/250

Push-in twin terminals: 0.5-1 mm² (lamp circuit)

Push-in terminals: 0.5-1 mm² (starter circuit)

Rear fixing hole for self-tapping screw
acc. to ISO 1481/7049-ST4.2-C/F

Front fixing holes for screws M3

Locking of the lampholder by a 15° turn

Weight: 13.7 g, unit: 500 pcs.

Type: 35610

Ref. No.: 109235

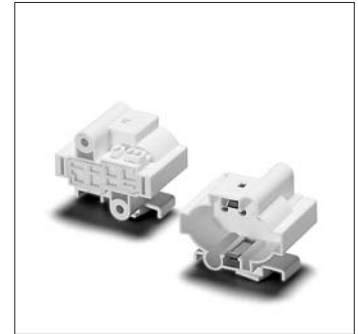
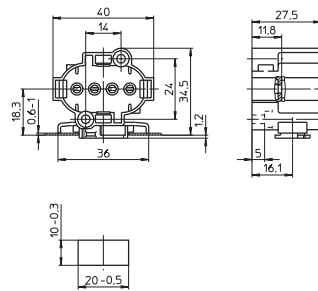

2G7 push-fit lampholder

Casing: PBT GF, white, T140

Nominal rating: 2/250

Push-in twin terminals: 0.5-1 mm² (lamp circuit)

Push-in terminals: 0.5-1 mm² (starter circuit)

Push-fit foot for cut-out 10x20 mm

for wall thickness 0.6-1 mm

Weight: 18 g, unit: 500 pcs.

Type: 35613

Ref. No.: 500574

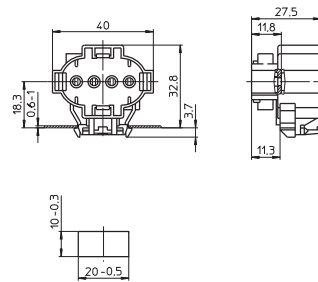

2G7 surface-mounted lampholder

Casing: PBT GF, white, T140, nominal rating: 2/250

Push-in twin terminals: 0.5-1 mm² (lamp circuit)

Push-in terminals: 0.5-1 mm² (starter circuit)

Fixing holes for screws M4

Lateral and rear fixing holes for self-tapping screws
acc. to ISO 1481/7049-ST4.2-C/F

Front fixing holes for screws M3

Weight: 18.1 g, unit: 500 pcs.

Type: 35611

Ref. No.: 109238

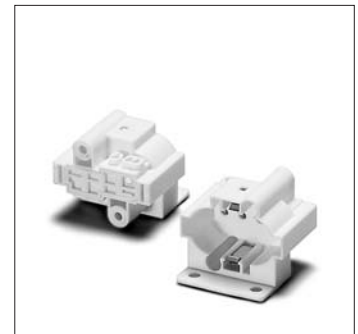
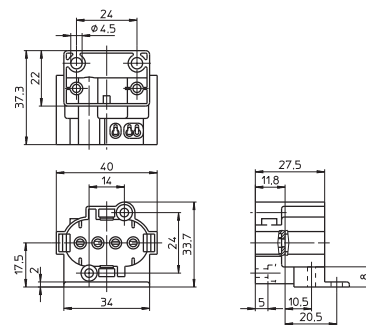

2G7 surface-mounted lampholder

Casing: PBT GF, white, T140

Nominal rating: 2/250

Push-in twin terminals: 0.5-1 mm² (lamp circuit)

Push-in terminals: 0.5-1 mm² (starter circuit)

Rear fixing holes for self-tapping screws
acc. to ISO 1481/7049-ST4.2-C/F

Front fixing holes for screws M3

Weight: 14 g, unit: 500 pcs.

Type: 35612

Ref. No.: 109240

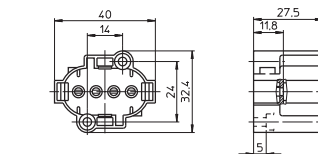

G23 Lampholders

For single-ended compact fluorescent lamps TC-S

If the central hole is used for mounting, make sure there is no risk of rotation.

G23 push-fit lampholder

Casing: PBT GF, white, T140

Nominal rating: 2/250

Push-in twin terminals: 0.5-1 mm²

Split pins for wall thickness up to 1.2 mm

Central fixing hole for screw M3

Weight: 12 g, unit: 500 pcs.

Type: 35004

Ref. No.: 101298

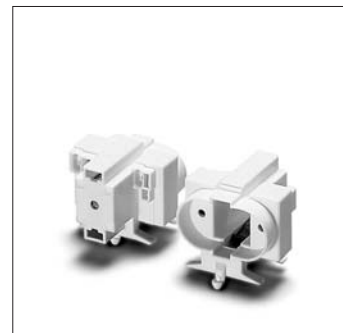
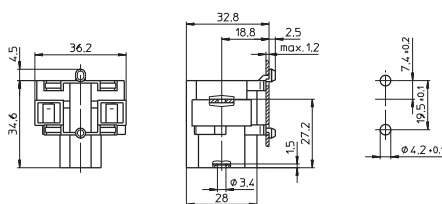

G23 surface-mounted lampholder

Casing: PBT GF, white, T140

Nominal rating: 2/250

Push-in twin terminals: 0.5-1 mm²

Fixing holes for screws M4

Central fixing hole for screw M3

Weight: 12.4 g, unit: 500 pcs.

Type: 35006

Ref. No.: 101306

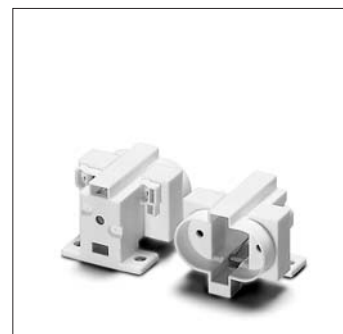
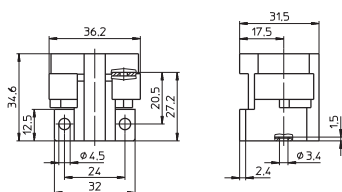

G23 lampholder

For push-fit on track

Casing: PBT GF, white, T140, nominal rating: 2/250

Push-in twin terminals: 0.5-1 mm²

Lateral fixing holes for self-tapping screws

acc. to ISO 1481/7049-ST2.9-C/F

Fixing holes for screws M4

Central fixing hole for screw M3

Weight: 14 g, unit: 500 pcs.

Type: 35007

Ref. No.: 101310

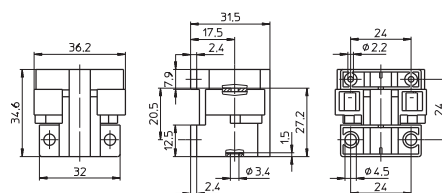

G23 surface-mounted lampholder

Casing: PBT GF, white, T140

Nominal rating: 2/250

Push-in twin terminals: 0.5-1 mm²

Fixing holes for screws M4

Central fixing hole for screw M3

Weight: 11.1 g, unit: 500 pcs.

Type: 35008

Ref. No.: 101314

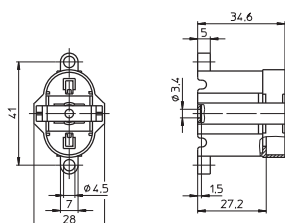

G23 lampholder

Casing: PBT GF, white, T140

Nominal rating: 2/250

Push-in terminals: 0.5-1 mm²

Central fixing hole for screw M3

Particularly suitable for narrow mounting
(e.g. for insertion into tube systems)

Weight: 8 g, unit: 500 pcs.

Type: 35201

Ref. No.: 101364

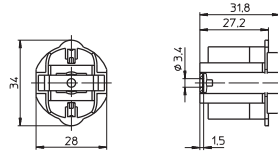

1

2

3

GR8, GR10q, GRY10q-3, GRZ10d, GRZ10t Lampholders

For single-ended compact fluorescent lamps TC-DD

GR8 push-fit lampholder

Casing: PC, white

Nominal rating: 2/250

Base and front push-in terminals: 0.5-1 mm²

Fixing clips for wall thickness up to 1 mm

Weight: 5.4 g, unit: 500 pcs.

Type: 35100

Ref. No.: 101358

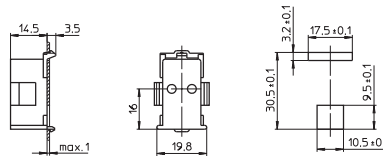

5

6

GR10q push-fit lampholder

Casing: PC, white, T110

Nominal rating: 2/250

Base push-in terminals: 0.5-1 mm²

Base fixing clip for wall thickness 0.6-1 mm

Weight: 6.2 g, unit: 1000 pcs.

Type: 35500

Ref. No.: 108927

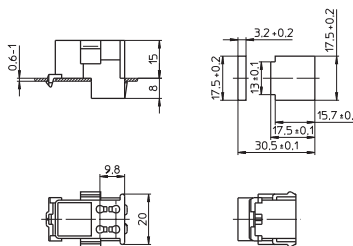

7

8

GR10q push-fit lampholder

Casing: PC, white, T110

Nominal rating: 2/250

Base push-in terminals: 0.5-1 mm²

Base split pins for wall thickness 0.6-1 mm

Weight: 6.2 g, unit: 1000 pcs.

Type: 35510

Ref. No.: 108928

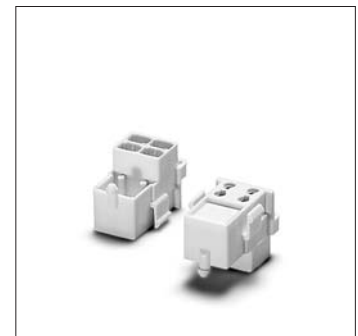
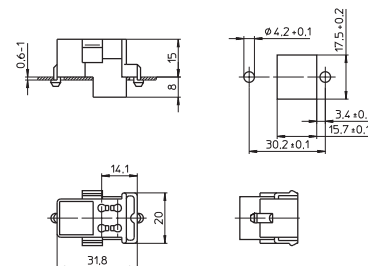

9

10

Lampholders and Accessories for TC Lamps

GR10q push-fit lampholder

Material: PBT, white, T110

Nominal rating: 2/250

Lateral push-in terminals: 0.5-1 mm²

Base fixing clip for wall thickness 0.6-1 mm

Weight: 7.2 g, unit: 1000 pcs.

Type: 35530

Ref. No.: 108932

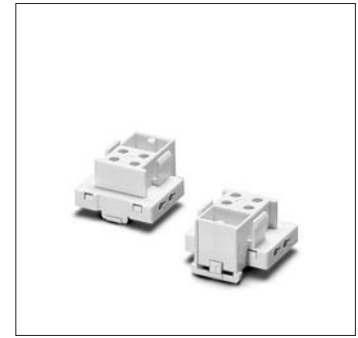
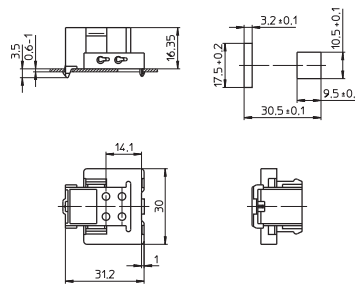

GR10q push-fit lampholder

Material: PBT, white, T110

Nominal rating: 2/250

Lateral push-in terminals: 0.5-1 mm²

Base split pins for wall thickness 0.6-1 mm

Weight: 7.2 g, unit: 1000 pcs.

Type: 35540

Ref. No.: 108933

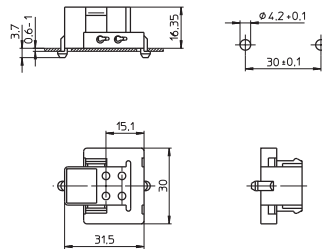

GR10q surface-mounted lampholder

Material: PBT, white, T110

Nominal rating: 2/250

Lateral push-in terminals: 0.5-1 mm²

Fastening slots for screws M3

Weight: 7.4 g, unit: 1000 pcs.

Type: 35550

Ref. No.: 108934

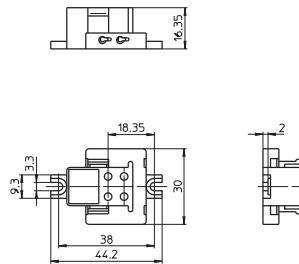

2G 10 Lampholders

For single-ended compact fluorescent lamps TC-F

2G 10 surface-mounted lampholder, with lamp lock

Casing: PBT GF, white, T140, nominal rating: 2/250

Push-in twin terminals: 0.5-1 mm²

Lateral lamp insertion

Front fixing holes for cheese-head screws M3

Rear fixing holes for self-lapping screws

acc. to ISO 1481/7049-ST4.2-C/F

Base fixing holes for screws M4

Weight: 25.5 g, unit: 250 pcs.

Type: 36300

Ref. No.: 101521

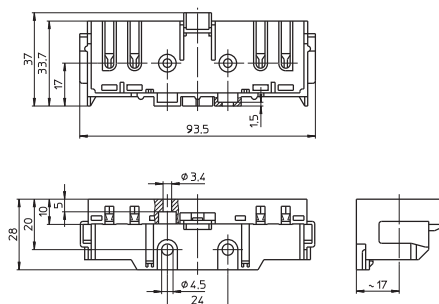

2G11/2GX11 Lampholders

For single-ended compact fluorescent lamps TC-L

2G11 surface-mounted lampholder

Casing: PBT GF, white, T140, nominal rating: 2/500

Push-in twin terminals: 0.5-1 mm² (lamp circuit)

Push-in terminals: 0.5-1 mm² (starter circuit)

Lateral pivots for bracket 105824 (see p. 179)

Base fixing holes for screws M4

Rear fixing holes for self-tapping screws

acc. to ISO 1481/7049-ST4.2-C/F

Front fixing holes for screws M3

Weight: 13.7 g, unit: 500 pcs.

Type: 36050

Ref. No.: 101485

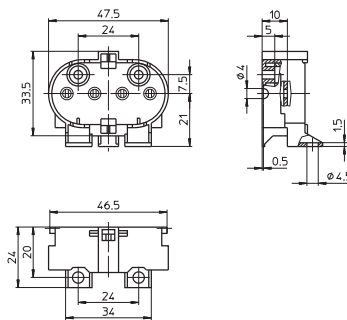

2G11 surface-mounted lampholder

Casing: PBT GF, white, T140, nominal rating: 2/500

Push-in twin terminals: 0.5-1 mm² (lamp circuit)

Push-in terminals: 0.5-1 mm² (starter circuit)

Lateral pivots for bracket 105824 (see p. 179)

Rear fixing holes for self-tapping screws

acc. to ISO 1481/7049-ST4.2-C/F

Front fixing holes for screws M3

Weight: 12.7 g, unit: 500 pcs.

Type: 36051

Ref. No.: 101489

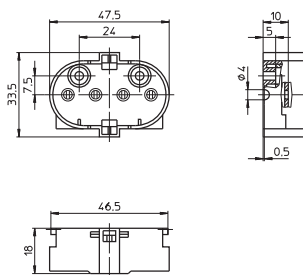

2GX11 surface-mounted lampholder

Casing: PBT GF, white, T140, nominal rating: 2/500

Push-in twin terminals: 0.5-1 mm² (lamp circuit)

Push-in terminals: 0.5-1 mm² (starter circuit)

Lateral pivots for bracket 105824 (see p. 179)

Base fixing holes for screws M4

Rear fixing holes for self-tapping screws

acc. to ISO 1481/7049-ST4.2-C/F

Front fixing holes for screws M3

Weight: 13.7 g, unit: 500 pcs.

Type: 36020

Ref. No.: 546609

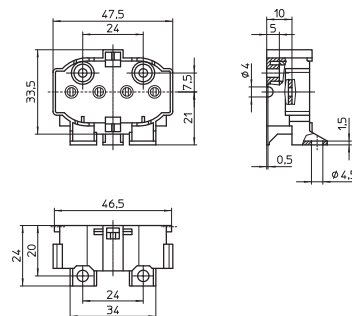

2GX11 surface-mounted lampholder

Casing: PBT GF, white, T140, nominal rating: 2/500

Push-in twin terminals: 0.5-1 mm² (lamp circuit)

Push-in terminals: 0.5-1 mm² (starter circuit)

Lateral pivots for bracket 105824 (see p. 179)

Rear fixing holes for self-tapping screws

acc. to ISO 1481/7049-ST4.2-C/F

Front fixing holes for screws M3

Weight: 12.7 g, unit: 500 pcs.

Type: 36021

Ref. No.: 546612

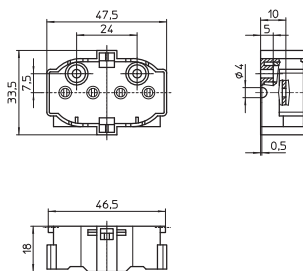

Lampholders and Accessories for TC Lamps

2G11 push-fit lampholder

Casing: PBT GF, white, T140, nominal rating: 2/500

Push-in twin terminals: 0.5-1 mm² (lamp circuit)

Push-in terminals: 0.5-1 mm² (starter circuit)

Lamp position: vertical

Rear fixing holes for self-tapping screws

acc. to ISO 1481/7049-ST4.2-C/F

Front fixing holes for screws M3

Weight: 14.3 g, unit: 500 pcs.

Type: 36052

Ref. No.: 101491

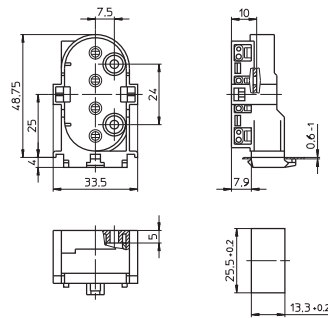

2G11 push-fit lampholder

Casing: PBT GF, white, T140, nominal rating: 2/500

Push-in twin terminals: 0.5-1 mm² (lamp circuit)

Push-in terminals: 0.5-1 mm² (starter circuit)

Rear fixing holes for self-tapping screws

acc. to ISO 1481/7049-ST4.2-C/F

Front fixing holes for screws M3

Option for base wiring

Weight: 14.1 g, unit: 500 pcs.

Type: 36053

Ref. No.: 101493

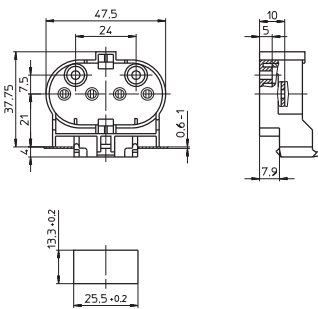

2G11 built-in lampholder

For the automatic luminaire wiring

Casing: PBT GF, white, T140

Nominal rating: 2/250

IDC terminals for leads H05V-U 0.5

Front and rear split pins

for wall thickness up to 1.2 mm

Weight: 10.5 g, unit: 500 pcs.

Type: 36011

Ref. No.: 500106

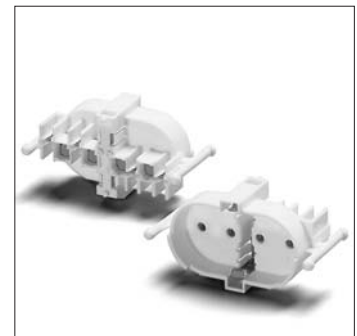
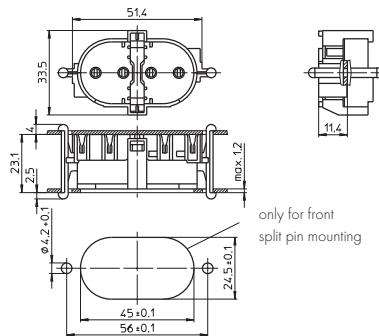

Accessories

For single-ended compact fluorescent lamps

The luminaire manufacturer is responsible for the right choice of accessories.

Cover caps for G24/GX24 lampholders (see p. 310–312)

Bracket

For 2G11 lampholders 101485 and 101489 (see p. 177)

To swivel the lampholder when changing the lamp

Material: PC, white

Oblong holes for screws M4

Base fixing holes for self-tapping screws acc. to ISO 1481/7049-ST2.9-C/F

Weight: 3.7 g, unit: 500 pcs.

Type: 97516

Ref. No.: 105824

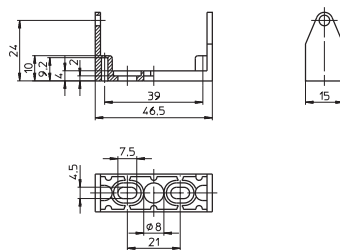

Lamp support for TC-D, TC-DEL lamps

Material: PC, white, UV-stabilised

Lamp position: 45°

Fixing foot with slot for screw M3.5

Weight: 1.5 g, unit: 500 pcs.

Type: 97031

Ref. No.: 105448

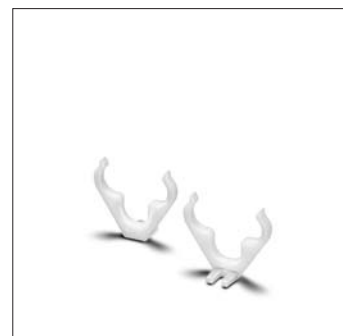
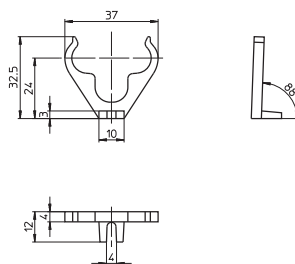

Lamp supports for TC-S, TC-SEL lamps

Height adjustable H: 17.5/20.5/23.5 mm

Push-fit foot for cut-out Ø 5.5 mm

for wall thickness up to 1 mm

Weight: 0.4/0.8/0.8 g, unit: 500 pcs.

Type: 35060

Ref. No.: 105775 foot, PC, white

Ref. No.: 105776 bracket, PC, crystal-clear, UV-stabilised

Ref. No.: 106416 bracket, PC, white, UV-stabilised

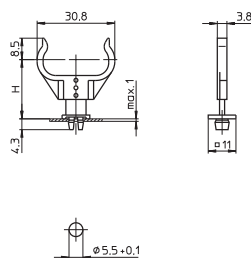

Lamp supports for TC-S, TC-SEL lamps

Height adjustable H: 27.5/30.5/33.5 mm

Push-fit foot for cut-out Ø 5.5 mm

for wall thickness up to 1 mm

Weight: 0.7/0.8/0.8 g, unit: 500 pcs.

Type: 35061

Ref. No.: 105931 foot, PC, white

Ref. No.: 105776 bracket, PC, crystal-clear, UV-stabilised

Ref. No.: 106416 bracket, PC, white, UV-stabilised

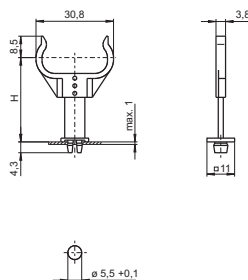

Lampholders and Accessories for TC Lamps

Lamp supports for TC-L lamps

Height adjustable H: 21/24/27 mm

Push-fit foot for cut-out \varnothing 5.5 mm

for wall thickness up to 1 mm

Weight: 0.4/1.3/1.1 g, unit: 500 pcs.

Type: 35760

Ref. No.: 105775 foot, PC, white

Ref. No.: 105777 bracket, PC, crystal-clear,
UV-stabilised

Ref. No.: 106417 bracket, PC, white,
UV-stabilised

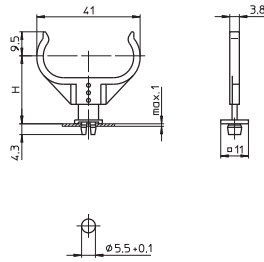

Lamp supports for TC-L lamps

Height adjustable H: 31/34/37 mm

Push-fit foot for cut-out \varnothing 5.5 mm

for wall thickness up to 1 mm

Weight: 0.7/1.3/1.1 g, unit: 500 pcs.

Type: 35761

Ref. No.: 105931 foot, PC, white

Ref. No.: 105777 bracket, PC, crystal-clear,
UV-stabilised

Ref. No.: 106417 bracket, PC, white,
UV-stabilised

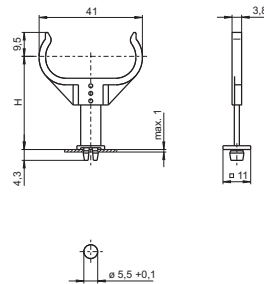

Lamp supports for TC-S, TC-SEL lamps

Material: stainless steel

Weight: 1.3 g, unit: 500 pcs.

Type: 93056 push-fit foot for \varnothing 5.5 mm

Ref. No.: 509522

Type: 93057 push-fit foot for 8.5x10.5 mm

Ref. No.: 509521

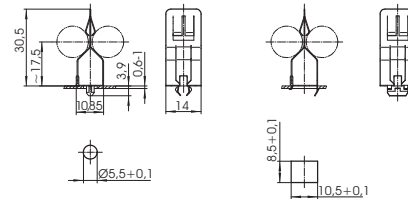

Lamp supports for TC-F, TC-L lamps

Material: stainless steel

Weight: 1.5 g, unit: 500 pcs.

Type: 93058 push-fit foot for \varnothing 5.5 mm

Ref. No.: 509520

Type: 93059 push-fit foot for 8.5x10.5 mm

Ref. No.: 509519

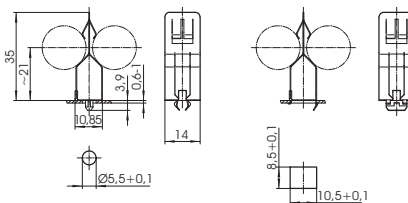

Lamp supports for TC-F, TC-L lamps

For wall thickness 0.6-1 mm

Material: PC, white, UV-stabilised

Weight: 1.3 g, unit: 500 pcs.

Type: 97638 push-fit foot for \varnothing 5.5 mm

Ref. No.: 105981

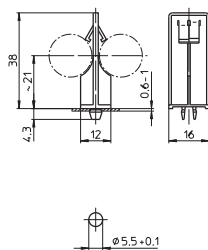

Lampholders and Accessories for TC Lamps

Lamp support for TC-L lamps
 Material: PC, white, UV-stabilised
 Push-fit foot for cut-out \varnothing 5.5 mm
 for wall thickness up to 1 mm
 Weight: 0.7 g, unit: 500 pcs.
 Type: 36060

Ref. No.: 108878

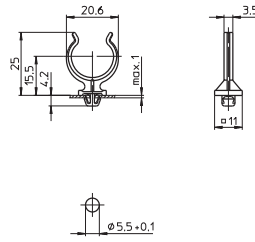

1

2

Lamp support for TC-L lamps
 Material: PC, crystal-clear, UV-stabilised
 Lockable
 Base split pins for wall thickness 0.6-1 mm
 Weight: 4 g, unit: 500 pcs.
 Type: 36061

Ref. No.: 101497

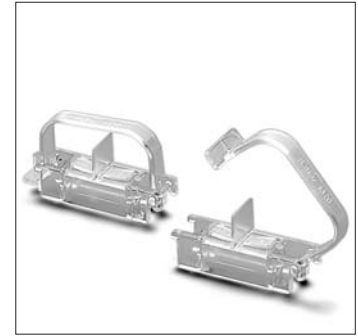
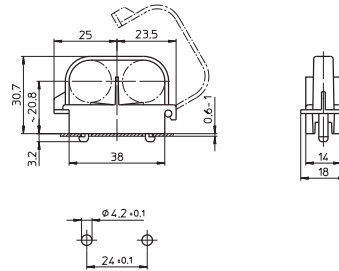

3

4

5

6

7

8

9

10

GX53-1 Lampholders, Accessories

For single-ended compact fluorescent lamps with integrated ballasts

GX53-1 lampholder

Casing: PC, white, T100, nominal rating: 2/250

Push-in terminals for through-wiring

for single-core leads: 0.5-1 mm²

for stranded leads:

0.75 mm², tinned lead ends

Fixing holes for screws M3

Weight: 12.8 g, unit: 200 pcs.

Type: 11000

Ref. No.: 530878

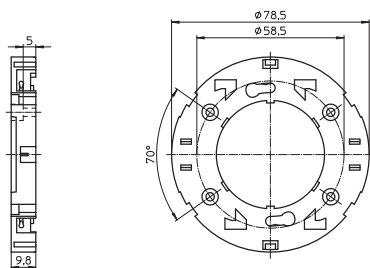

GX53-1 lampholder

Fixing springs for installation into furniture panels

Casing: PC, white, T100, nominal rating: 2/250

Push-in terminals for through-wiring

for single-core leads: 0.5-1 mm²

for stranded leads:

0.75 mm², tinned lead ends

Cut-out: $\varnothing 78^{+0.2}$ mm

Weight: 13.2 g, unit: 200 pcs.

Type: 11010

Ref. No.: 530879

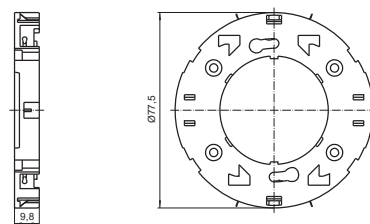

Cord grip/cover plate for GX53-1 lampholders

For leads H03VH2-F 2X0.75, tinned lead ends

For luminaires of protection class II

Material: PC, white

Weight: 1.6 g, unit: 200 pcs.

Type: 97278

Ref. No.: 504939

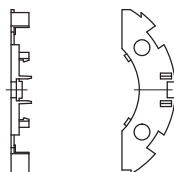

Surface-mounted installation ring

For wood or furniture panels

Material: PC, white

Weight: 10.4 g, unit: 100 pcs.

Type: 97277

Ref. No.: 504938



1

2

3

4

5

6

7

8

9

10

LAMPHOLDERS FOR T5, T8, T12 AND T2 LAMPS



VS LAMPHOLDERS FOR DOUBLE- ENDED FLUORESCENT LAMPS

Vossloh-Schwabe's comprehensive range of lampholders for double-ended fluorescent lamps covers all major fixing methods. Push-through, push-fit and built-in lampholders with split pins or catches are available just as models with screw and push fittings.

High-grade materials for the contacts and thermoplastics for the casings guarantee reliable contacts and a long service life of the components.

Special G13 lampholders for the USA and Canada can be found under www.unvlt.com.



3

Lampholders and Accessories for T Lamps

G5 lampholders

G5 lampholders, accessories
G5 twin lampholder
G5 lampholders, degree of protection IP54/IP65/IP67
2GX13 lampholders, accessories

G13 lampholders

G13 push-through lampholders
G13 push-fit lampholders
G13 push-fit twin lampholders, accessories
G13 built-in lampholders
G13 surface-mounted lampholders
Accessories for T8 and T12 lamps
G13 lampholders, degree of protection IP54/IP65/IP67, accessories
G10q lampholders, accessories

Technical details for fluorescent lamps

General technical details
Glossary

186–193

186–190
191
191–192
193

194–214

194–196
197–199
200–201
201–204
205–206
206–208
209–213
214

226–253

366–374
375–377

1

2

3

4

5

6

7

8

9

10

G5 Lampholders, Accessories

For fluorescent lamps T5 (T16)

Max. permitted temperature T_m
on the rear side of the lampholder: 110 °C

G5 push-through/surface-mounted lampholder
Lamp axis push-through lampholder: 13.2 mm
Lamp axis surface-mounted lampholder: 15.2 mm
Casing: PC, white, T110
Nominal rating: 2/500
Push-in terminals: 0.5-1 mm²
Lateral fixing clips for wall thickness 0.5-1.5 mm
Fixing slot for screw M3
Weight: 3.2 g, unit: 1000 pcs.
Type: 09105

Ref. No.: 100305

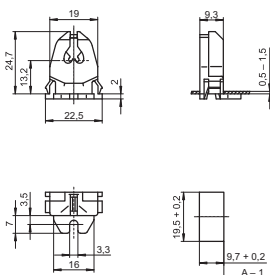

G5 built-in lampholder
Casing: PC, white, T110
Nominal rating: 2/500
Push-in terminals: 0.5-1 mm²
Rear split pins for wall thickness up to 1.2 mm
Weight: 2.6 g, unit: 1000 pcs.
Type: 09205

Ref. No.: 100310

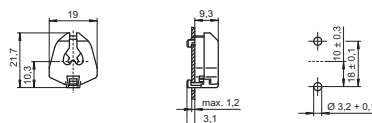

G5 built-in/push-fit lampholder
Lamp axis: 12 mm
Casing: PC, white, T110
Nominal rating: 2/500
Push-in terminals: 0.5-1 mm²
Rear split pins for wall thickness up to 1.2 mm
Base split pins for wall thickness up to 1 mm
Weight: 2.9 g, unit: 1000 pcs.
Type: 09210

Ref. No.: 106455

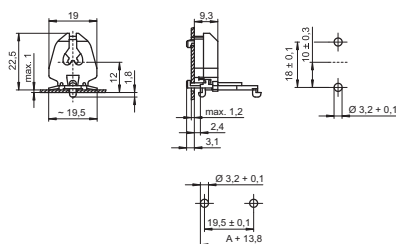

G5 push-through lampholders
For the automatic luminaire wiring
Casing: PBT GF, white, frontplate: PC, white
Rotor: PBT GF, white, T140, lamp axis: 15 mm
Nominal rating: 2/500
IDC terminals for leads H05V-U 0.5
Lateral fixing clips for wall thickness 0.5-1.5 mm
Weight: 5 g, unit: 1000 pcs.
Type: 09420/ 09421

Ref. No.: 532377 with stop

Ref. No.: 532378 without stop

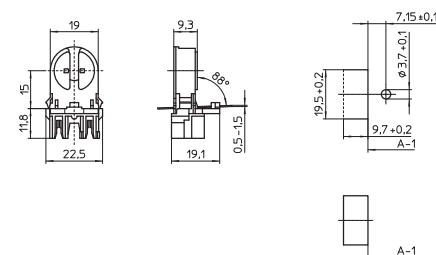

Lampholders and Accessories for T Lamps

G5 push-through lampholders

For the automatic luminaire wiring

Casing: PBT GF, white, frontplate: PC, white

Rotor: PBT GF, white, T140, lamp axis: 20 mm

Nominal rating: 2/500

IDC terminals for leads H05V-U 0.5

Lateral fixing clips for wall thickness 0.5–1.5 mm

Weight: 5.6 g, unit: 1000 pcs.

Type: 09422/09423

Ref. No.: 532379 with stop

Ref. No.: 532380 without stop

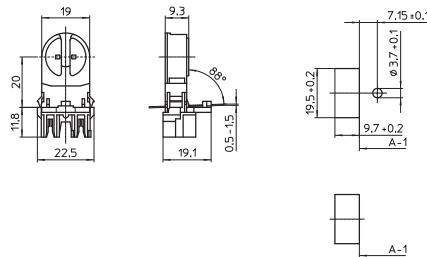

1

2

G5 push-fit lampholder

For the automatic luminaire wiring

Lamp axis: 18 mm

Casing: PC, white, rotor: PBT GF, white, T130

Nominal rating: 2/500

IDC terminals for leads H05V-U 0.5

Lateral push-in twin terminals: 0.5–1 mm²

Weight: 5.5 g, unit: 1000 pcs.

Type: 09900

Ref. No.: 534644

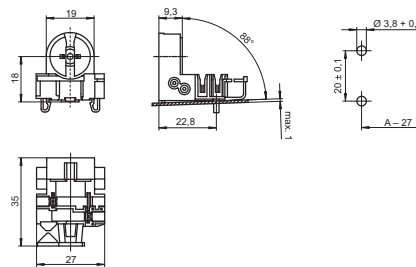

3

4

G5 built-in lampholders

For the automatic luminaire wiring

Casing: PC, white, rotor: PBT GF, white, T130

Nominal rating: 2/500

IDC terminals for leads H05V-U 0.5

Rear split pins for wall thickness up to 1.2 mm

Weight: 3.7/4.1 g, unit: 1000 pcs.

Type: 09145

Ref. No.: 501533

Type: 09146 with spring adjustment

Ref. No.: 501534

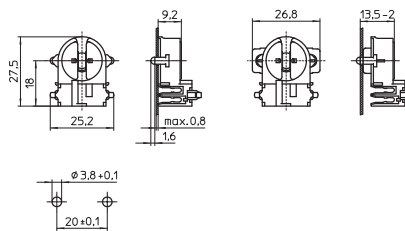

5

6

G5 built-in lampholder

Casing: PBT GF, white, rotor: PBT GF, white

T140, nominal rating: 2/500

Push-in twin terminals: 0.5–1 mm²

Lateral fixing clips

Weight: 2.8 g, unit: 1000 pcs.

Type: 09404

Ref. No.: 505732

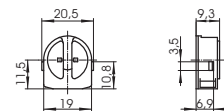

7

8

G5 built-in lampholders

Casing: PBT GF, white, rotor: PBT GF, white

T140, nominal rating: 2/500

Push-in twin terminals: 0.5–1 mm²

Rear split pins for wall thickness up to 1.2 mm

Weight: 2.9/3.3 g, unit: 1000 pcs.

Type: 09405

Ref. No.: 505733

Type: 09406 with spring adjustment

Ref. No.: 505734

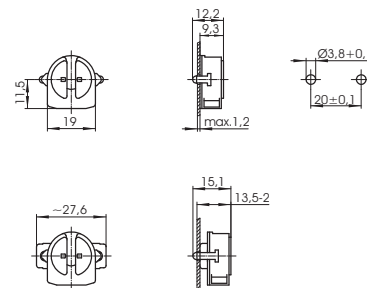

9

10

Lampholders and Accessories for T Lamps

G5 built-in lampholder

Lampholder thickness: 12.5 mm
 Casing: PBT GF, white, rotor: PBT GF, white
 T140, nominal rating: 2/500
 Push-in twin terminals: 0.5–1 mm²
 Rear split pins for wall thickness up to 1 mm
 Weight: 3 g, unit: 1000 pcs.
 Type: 09407

Ref. No.: 508590

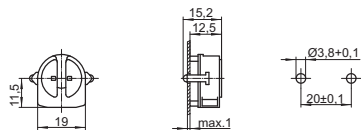

G5 built-in lampholders

Casing: PBT GF, white, rotor: PBT GF, white
 T140, nominal rating: 2/500
 Push-in twin terminals: 0.5–1 mm²
 Rear split pins for wall thickness up to 1.2 mm
 Weight: 2.9/3.2 g, unit: 1000 pcs.
 Type: 09415

Ref. No.: 505735

Type: 09416 with spring adjustment

Ref. No.: 505736

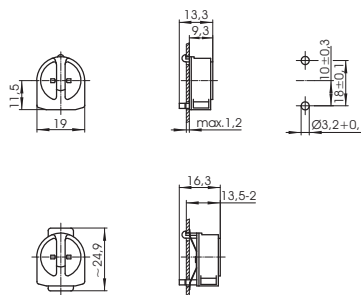

G5 push-through lampholders

Lamp axis: 15 mm
 Casing: PBT GF, white, rotor: PBT GF, white
 T140, nominal rating: 2/500
 Push-in twin terminals: 0.5–1 mm²
 Lateral fixing clips for wall thickness 0.5–1.5 mm
 Weight: 3.5/3.4 g, unit: 1000 pcs.
 Type: 09420/09421

Ref. No.: 505737 with stop

Ref. No.: 505739 without stop

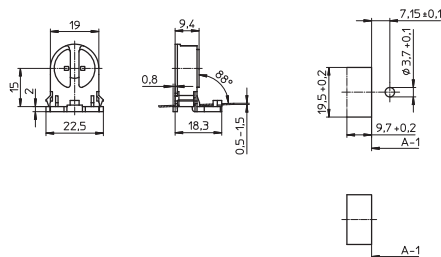

G5 push-through lampholders

Lamp axis: 20 mm
 Casing: PBT GF, white, rotor: PBT GF, white
 T140, nominal rating: 2/500
 Push-in twin terminals: 0.5–1 mm²
 Lateral fixing clips for wall thickness 0.5–1.5 mm
 Weight: 4.1 g, unit: 1000 pcs.
 Type: 09432/09433

Ref. No.: 545933 with stop

Ref. No.: 545935 without stop

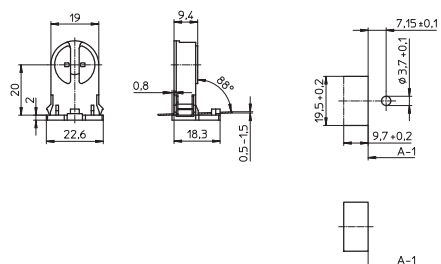

G5 push-through lampholders

Lamp axis: 25 mm
 Casing: PBT GF, white, rotor: PBT GF, white
 T140, nominal rating: 2/500
 Push-in twin terminals: 0.5–1 mm²
 Lateral fixing clips for wall thickness 0.5–1.5 mm
 Weight: 4.5 g, unit: 1000 pcs.
 Type: 09434/09435

Ref. No.: 545937 with stop

Ref. No.: 545939 without stop

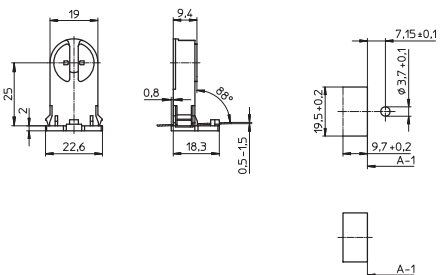

Lampholders and Accessories for T Lamps

G5 push-through lampholders

Lamp axis: 35 mm

Casing: PBT GF, white, rotor: PBT GF, white

T140, nominal rating: 2/500

Push-in twin terminals: 0.5-1 mm²

Lateral fixing clips for wall thickness 0.5-1.5 mm

Weight: 4.6 g, unit: 1000 pcs.

Type: 09426/09427

Ref. No.: 505745 with stop

Ref. No.: 505746 without stop

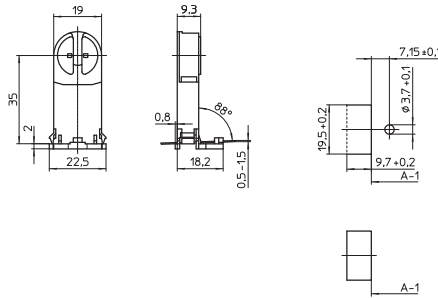

1

2

G5 push-fit lampholder

Lamp axis: 14 mm

Casing: PBT GF, white, rotor: PBT GF, white

T140, nominal rating: 2/500

Push-in twin terminals: 0.5-1 mm²

Rear fixing clips for wall thickness 0.6-1 mm

Base or lateral wiring

Weight: 3.3 g, unit: 1000 pcs.

Type: 09440

Ref. No.: 505747

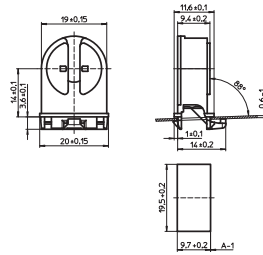

3

4

G5 push-fit lampholder

Lamp axis: 18 mm

Casing: PBT GF, white, rotor: PBT GF, white

T140, nominal rating: 2/500

Push-in twin terminals: 0.5-1 mm²

Rear fixing clips for wall thickness 0.6-1 mm

Base or lateral wiring

Weight: 3.9 g, unit: 1000 pcs.

Type: 09446

Ref. No.: 545894

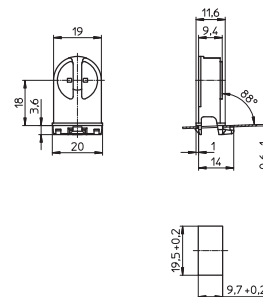

5

6

G5 push-fit lampholder

Lamp axis: 23 mm

Casing: PBT GF, white, rotor: PBT GF, white

T140, nominal rating: 2/500

Push-in twin terminals: 0.5-1 mm²

Rear fixing clips for wall thickness 0.6-1 mm

Base or lateral wiring

Weight: 4.2 g, unit: 1000 pcs.

Type: 09447

Ref. No.: 545896

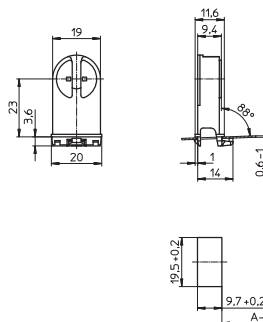

7

8

G5 push-fit lampholder

Lamp axis: 15 mm

Casing: PBT GF, white, rotor: PBT GF, white

T140, nominal rating: 2/500

Push-in twin terminals: 0.5-1 mm²

Base split pins for wall thickness 0.6-1 mm

Weight: 3.4 g, unit: 1000 pcs.

Type: 09450

Ref. No.: 505750

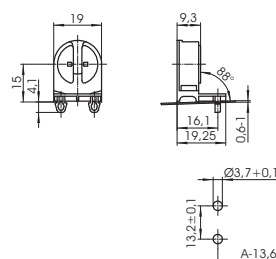

9

10

Lampholders and Accessories for T Lamps

G5 push-fit lampholder

Lamp axis: 11.8 mm

Casing: PBT GF, white, rotor: PBT GF, white

T140, nominal rating: 2/500

Push-in twin terminals: 0.5-1 mm²

Base split pins for wall thickness up to 1 mm

Lateral wiring

Weight: 3.1 g, unit: 1000 pcs.

Type: 09460

Ref. No.: 505751

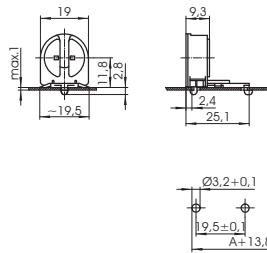

G5 lampholder

For push-fit onto the lamp

Casing: PBT GF, white, T130

Nominal rating: 2/500

Push-in twin terminals: 0.5-1 mm²

Pin support for reliable contact

Lamp support 109685 (see below)

Weight: 3.7 g, unit: 1000 pcs.

Type: 09170

Ref. No.: 109686

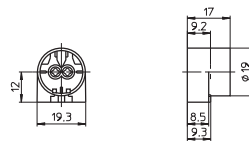

Lamp support for lamps Ø 16 mm

Material: zinc-coated polished steel

Fixing hole for screw M3.5

Weight: 1.3 g, unit: 1000 pcs.

Type: 94088

Ref. No.: 109685

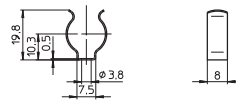

Lamp support for lamps Ø 16 mm

Material: PC, white, UV-stabilised

Push-fit foot for cut-out Ø 5.5 mm

Weight: 1 g, unit: 500 pcs.

Type: 84001

Ref. No.: 500757

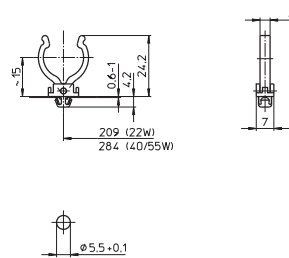

G5 Twin Lampholder

For fluorescent lamps T5 (T16)

Max. permitted temperature T_m
on the rear side of the lampholder: 110 °C

G5 built-in lampholder
Casing: PBT GF, white, rotor: PBT GF, white
T140, nominal rating: 2/500
Push-in twin terminals: 0.5-1 mm²
Lateral fixing clips
Weight: 2.8 g, unit: 1000 pcs.
Type: 09404
Ref. No.: 505732

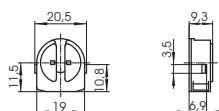

Push-fit bracket
For two G5 built-in lampholders 505732
Material: PC, white
Lamp axis: 20 mm
Distance between two lamp axes: 24 mm
Push-fit foot for wall thickness 0.5-1 mm
Weight: 3.5 g, unit: 1000 pcs.
Type: 97677
Ref. No.: 507562

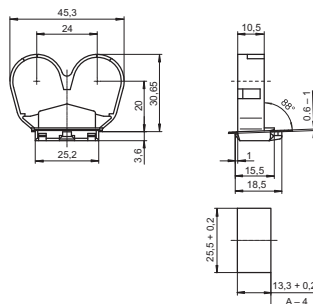

G5 Lampholders, Degree of Protection IP54/IP65/IP67

For fluorescent lamps T5 (T16)
For luminaires of protection class I and II

Lampholders protected against dust and splashing water (IP54)
Lampholders protected against dust and jet of water (IP65)
Dust and watertight lampholders (IP67)

Pin support for reliable contact
With spring adjustment
Max. permitted temperature T_m
on the rear side of the lampholder: 110 °C

G5 push-fit lampholder for metal casing
Casing: PC, white, interior part: PBT GF
T140, nominal rating: 2/500
Push-in twin terminals: 0.5-1 mm²
Push-fit foot for wall thickness: 1.4-2 mm
Weight: 11.3 g, unit: 250 pcs.
Type: 84101 system 153
Ref. No.: 529832

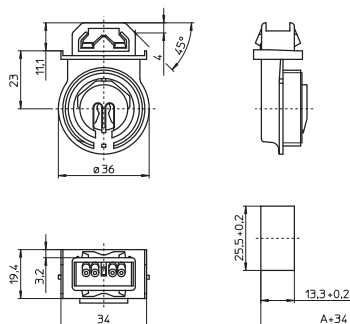

Lampholders and Accessories for T Lamps

G5 push-fit lampholder for plastic casing
 Casing: PC, white, interior part: PBT GF
 T140, nominal rating: 2/500
 Push-in twin terminals: 0.5-1 mm²
 Push-fit foot for wall thickness: 0.4-1 mm
 Weight: 11.6 g, unit: 250 pcs.
 Type: 84104 system 154

Ref. No.: 530535

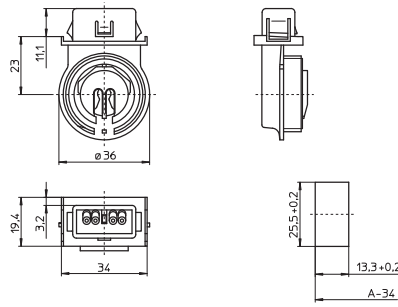

Foot gaskets for systems 153 and 154
 Weight: 0.5/0.7/0.7 g
 Unit: 1000 pcs.

Type: 98002 degree of protection IP67

Ref. No.: 108947 material: PE foam

Type: 98087 degree of protection IP67

Ref. No.: 503773 material: EPDM, black

Type: 98003 degree of protection IP54

Ref. No.: 108266 material: EPDM, black

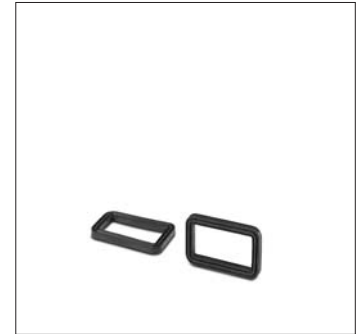
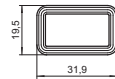
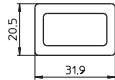

G5 push-fit lampholder

Casing: PC, white, interior part: PBT GF

T140, nominal rating: 2/500

Push-in twin terminals: 0.5-1 mm²

Push-fit foot for wall thickness: 1.4-2 mm

Weight: 12.7 g, unit: 250 pcs.

Type: 84108 system 151

Ref. No.: 534073

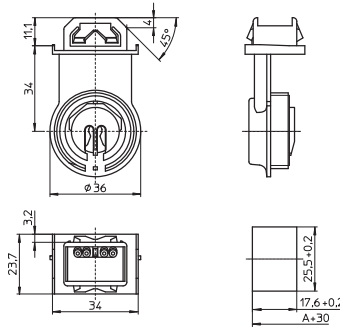

Foot gaskets for system 151

Weight: 1/1.1/1.1 g

Unit: 1000 pcs.

Type: 98004 degree of protection IP65

Ref. No.: 108267 material: cellular rubber, black

Type: 98011 degree of protection IP67

Ref. No.: 504078 material: silicone, transparent

Type: 98008 degree of protection IP67

Ref. No.: 546254 profiled foot gasket, material: EPDM, black

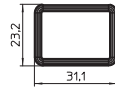
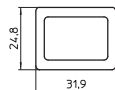

Screw ring for systems 151, 153 and 154

Ring: PBT GF, white, gasket: silicone

Weight: 11.8 g, unit: 250 pcs.

Type: 84103

Ref. No.: 529836

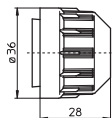

2GX13 Lampholders, Accessories

For fluorescent lamps T-R5 (T-R16)

2GX13 push-fit lampholder

Lamp axis: 15 mm

Casing: PC, white, T110

Nominal rating: 2/500

Push-in terminals: 0.5-1 mm²

Base push-fit studs for wall thickness up to 1.2 mm

Weight: 10 g, unit: 500 pcs.

Type: 58110

Ref. No.: 546656

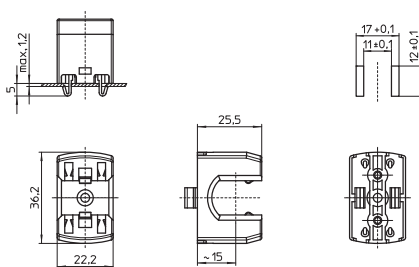

2GX13 surface-mounted lampholder

Lamp axis: 15 mm

Casing: PC, white, T110

Nominal rating: 2/500

Push-in terminals: 0.5-1 mm²

Rear fixing holes for self-tapping screws acc. to ISO 1481/7049-ST2.9-C/F

Lateral fixing holes for screws M3

Weight: 10.6 g, unit: 500 pcs.

Type: 58100

Ref. No.: 546655

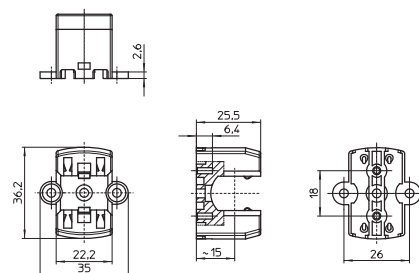

Lamp support for lamps Ø 16 mm

Material: PC, white, UV-stabilised

Fixing hole for screw M3

Fixing hole for self-tapping screw acc. to ISO 1481/7049-ST4.2-C/F

Weight: 1 g, unit: 500 pcs.

Type: 84000

Ref. No.: 109532

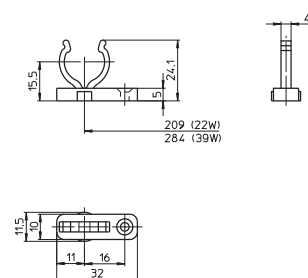

Lamp support for lamps Ø 16 mm

Material: PC, white, UV-stabilised

Push-fit foot for cut-out Ø 5.5 mm

Weight: 1 g, unit: 500 pcs.

Type: 84001

Ref. No.: 500757

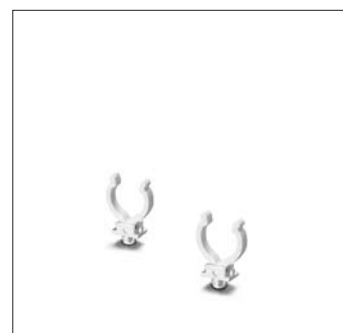
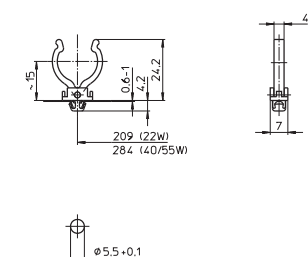

1

2

3

4

5

6

7

8

9

10

G13 Push-through Lampholders

For fluorescent lamps T8 (T26), T12 (T38)

Lampholders with integrated starter holder have push-in twin terminals for the lamp circuit and push-in terminals for the starter circuit.

Pin support for reliable contact

Max. permitted temperature T_m

on the rear side of the lampholder: 110 °C

G13 push-through lampholders for lamps T8 and T12

Lamp axis: 23 mm

Casing: PC, white, frontplate: PBT GF, white

T140, nominal rating: 2/500

Push-in terminals: 0.5-1 mm²

Lateral fixing clips for wall thickness 0.4-2 mm

Weight: 6 g, unit: 1000 pcs.

Type: 27700/27701

Ref. No.: 109330 with stop

Ref. No.: 109331 without stop

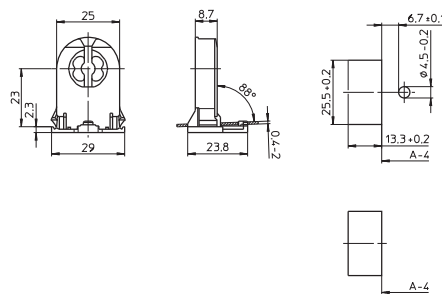

G13 Rotoclic push-through lampholders

for lamps T8 and T12

Lamp axis: 23 mm

Casing: PC, white, frontplate: PBT GF, white

T140, nominal rating: 2/500

Push-in terminals: 0.5-1 mm²

Lateral fixing clips for wall thickness 0.4-2 mm

Weight: 6.8 g, unit: 1000 pcs.

Type: 27700/27701

Ref. No.: 546641 with stop

Ref. No.: 546642 without stop

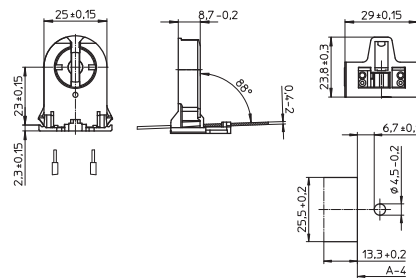

G13 push-through lampholders for lamps T8

With starter attachment

Lamp axis: 23 mm

Casing: PC, white, frontplate: PBT GF, white

T140, nominal rating: 2/500

Push-in terminals: 0.5-1 mm²

Lateral fixing clips for wall thickness 0.4-2 mm

Weight: 10.4 g, unit: 500 pcs.

Type: 27800/27801

Ref. No.: 109332 with stop

Ref. No.: 109335 without stop

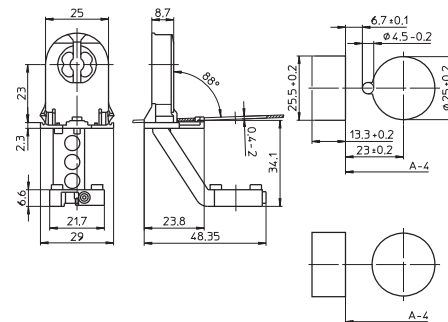

G13 Rotoclic push-through lampholders

for lamps T8, with starter attachment

Lamp axis: 23 mm

Casing: PC, white, frontplate: PBT GF, white

T140, nominal rating: 2/500

Push-in terminals: 0.5-1 mm²

Lateral fixing clips for wall thickness 0.4-2 mm

Weight: 10.4 g, unit: 500 pcs.

Type: 27800/27801

Ref. No.: 546647 with stop

Ref. No.: 546648 without stop

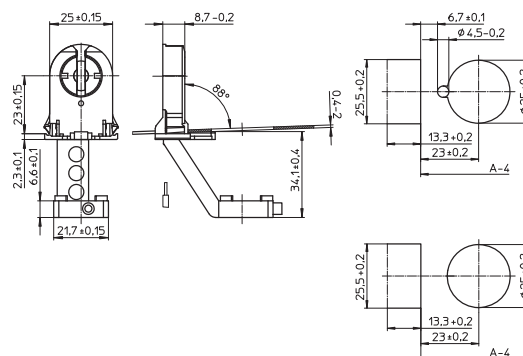

Lampholders and Accessories for T Lamps

G13 push-through lampholders for lamps T8, T12

Lamp axis: 17 mm

Casing: PC, white, frontplate: PBT GF, white

T140, nominal rating: 2/500

Push-in terminals: 0.5-1 mm²

Lateral fixing clips for wall thickness 0.4-2 mm

Weight: 5,4 g, unit: 1000 pcs.

Type: 26300/26310

Ref. No.: 551271 with stop

Ref. No.: 551272 without stop

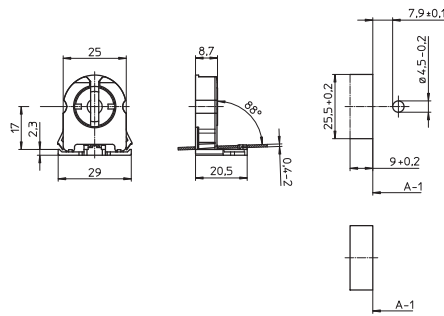

1

2

G13 push-through lampholders for lamps T8 and T12

With starter attachment

Lamp axis: 22.5 mm

Casing: PC, white, rotor: PBT, white

T130, nominal rating: 2/500

Push-in terminals: 0.5-1 mm²

Lateral fixing clips for wall thickness 0.6-2 mm

Weight: 9.5 g, unit: 500 pcs.

Type: 27820/27821

Ref. No.: 100579 with stop

Ref. No.: 100581 without stop

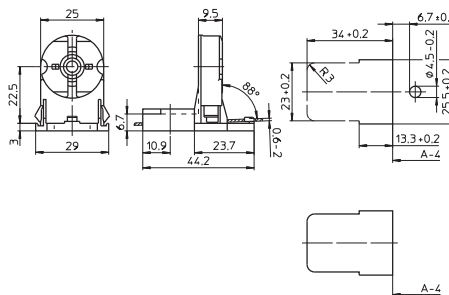

3

4

G13 push-through lampholders for lamps T8 and T12

Lamp axis: 31 mm

Casing: PC, white, frontplate: PBT GF, white

T140, nominal rating: 2/500

Push-in terminals: 0.5-1 mm²

Lateral fixing clips for wall thickness 0.4-2 mm

Weight: 7.8 g, unit: 1000 pcs.

Type: 28500/28501

Ref. No.: 109338 with stop

Ref. No.: 109339 without stop

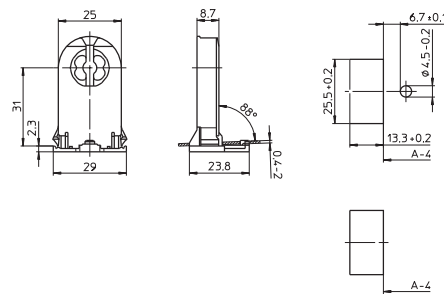

5

6

G13 push-through lampholders for lamps T8 and T12

With starter attachment

Lamp axis: 31 mm

Casing: PC, white, frontplate: PBT GF, white

T140, nominal rating: 2/500

Push-in terminals: 0.5-1 mm²

Lateral fixing clips for wall thickness 0.4-2 mm

Weight: 10.3/10.1 g, unit: 500 pcs.

Type: 28600/28601

Ref. No.: 109340 with stop

Ref. No.: 109341 without stop

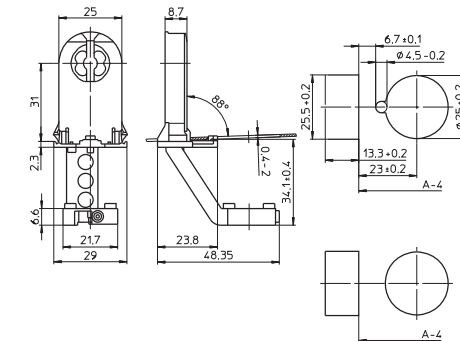

7

8

G13 push-through lampholders for lamps T8 and T12

Lamp axis: 31 mm

Casing: PC, white, rotor: PBT GF, white

T130, nominal rating: 2/500

Push-in terminals: 0.5-1 mm²

Lateral fixing clips for wall thickness 0.6-2 mm

Weight: 9.6 g, unit: 500 pcs.

Type: 28740/28741

Ref. No.: 542983 with stop

Ref. No.: 542984 without stop

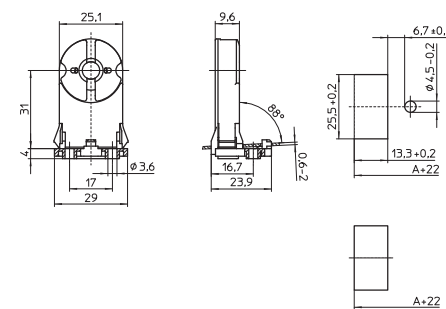

9

10

Lampholders and Accessories for T Lamps

G13 push-through lampholders for lamps T8 and T12

Lamp axis: 31 mm

Casing: PC, white, rotor: PBT, white

T130, nominal rating: 2/500

Push-in terminals: 0.5-1 mm²

Lateral fixing clips for wall thickness 0.6-2 mm

Weight: 9.9 g, unit: 1000 pcs.

Type: 28500/28501

Ref. No.: 100591 with stop

Ref. No.: 100593 without stop

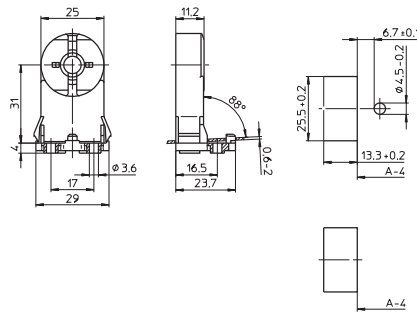

G13 push-through lampholders for lamps T8 and T12

For the automatic luminaire wiring

Lamp axis: 23 mm

Casing: PC, white, frontplate: PBT GF, white

T140, nominal rating: 2/500

IDC terminals for leads H05V-U 0.5

Lateral fixing clips for wall thickness 0.4-2 mm

Weight: 7.7/7.5 g, unit: 1000 pcs.

Type: 27780/27781

Ref. No.: 526019 with stop

Ref. No.: 526020 without stop

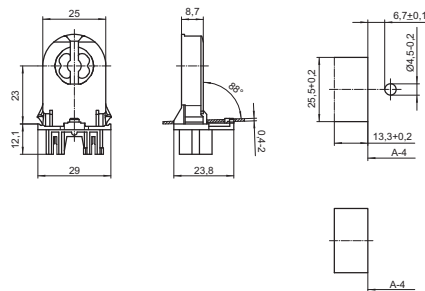

G13 push-through lampholders for lamps T8 and T12

For the automatic luminaire wiring

Lamp axis: 31 mm

Casing: PC, white, frontplate: PBT GF, white

T140, nominal rating: 2/500

IDC terminals for leads H05V-U 0.5

Lateral fixing clips for wall thickness 0.4-2 mm

Weight: 8.8/8.6 g, unit: 1000 pcs.

Type: 28580/28581

Ref. No.: 526021 with stop

Ref. No.: 526022 without stop

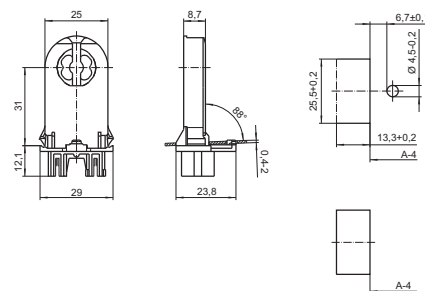

Lampholders and Accessories for T Lamps

G13 push-fit lampholders with starter attachment for lamps T8

T130, nominal rating: 2/250

Base push-in terminals: 0.5-1 mm²

Base split pins for wall thickness up to 1.2 mm

Lampholder foot/luminaire: IP40

Weight: 9.7/9.5 g, unit: 1000 pcs.

Type: 27460/27450

Ref. No.: 100559 lamp axis H: 30 mm

Ref. No.: 100557 lamp axis H: 23.5 mm

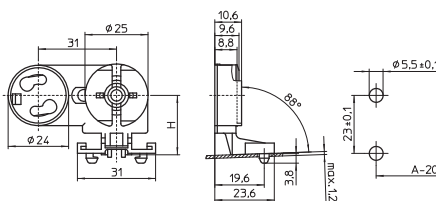

G13 push-fit lampholders for lamps T8 and T12

Lamp axis H: 25 mm

T130, nominal rating: 2/500

Base push-in terminals: 0.5-1 mm²

Push-fit foot for luminaire cut-out 13.3x25.5 mm

with wall thickness 0.5-1 mm

Lampholder foot/luminaire: IP40

Weight: 5/11 g, unit: 500 pcs.

Type: 28100/28200

Ref. No.: 100585

Ref. No.: 100588 with starter attachment

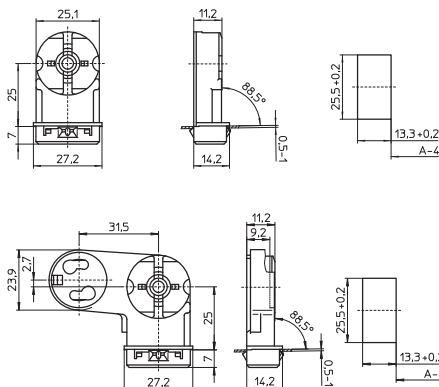

G13 push-fit lampholder for lamps T8

For the automatic luminaire wiring

Lamp axis: 21 mm

T130, nominal rating: 2/250

IDC terminals for leads H05V-U 0.5

Base split pins for wall thickness up to 1 mm

The lampholder is wired in its horizontal position

before being brought into its vertical service position

Weight: 6.7 g, unit: 1000 pcs.

Type: 48230

Ref. No.: 108730

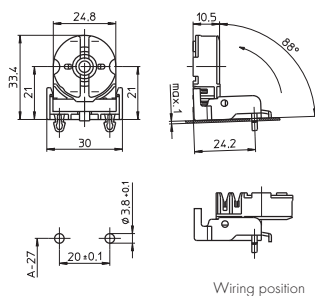

G13 push-fit lampholder for lamps T8

For the automatic luminaire wiring

Lamp axis: 31 mm

T130, nominal rating: 2/500

IDC terminals for leads H05V-U 0.5

Base split pins for wall thickness up to 1 mm

Weight: 7.2 g, unit: 1000 pcs.

Type: 28310

Ref. No.: 506007

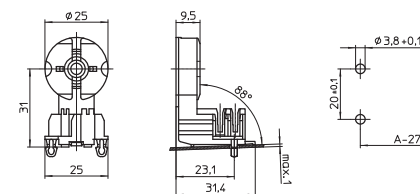

G13 push-fit lampholder for lamps T8

For the automatic luminaire wiring

Lamp axis: 26.5 mm

T130, nominal rating: 2/500

IDC terminals for leads H05V-U 0.5

Base split pins for wall thickness up to 1 mm

Weight: 7.1 g, unit: 1000 pcs.

Type: 28315

Ref. No.: 504202

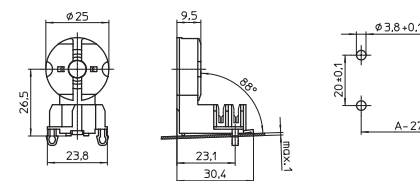

Lampholders and Accessories for T Lamps

G13 push-fit lampholder for lamps T8

For the automatic luminaire wiring

Lamp axis: 31 mm

T130, nominal rating: 2/500

IDC terminals for leads H05V-U 0.5

Lateral push-in twin terminals: 0.5-1 mm²

Base split pins for wall thickness up to 1 mm

Front cable holder for up to 3 individual conductors

Weight: 8 g, unit: 1000 pcs.

Type: 28330

Ref. No.: 508423

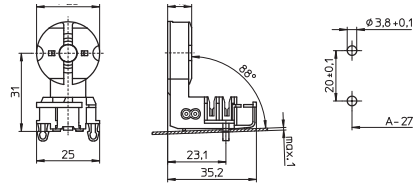

1

2

G13 push-fit lampholders

Lamp axis: 25 mm

T130, nominal rating: 5/500

Lateral and base push-in terminals: 0.5-1 mm²

Push-fit foot for luminaire cut-out 10x20 mm

for wall thickness 0.4-1 mm

Weight: 6/8.5 g, unit: 500 pcs.

Type: 28921/28920

Ref. No.: 108438 for lamps T8 and T12

Ref. No.: 108437 for lamps T8

with starter attachment

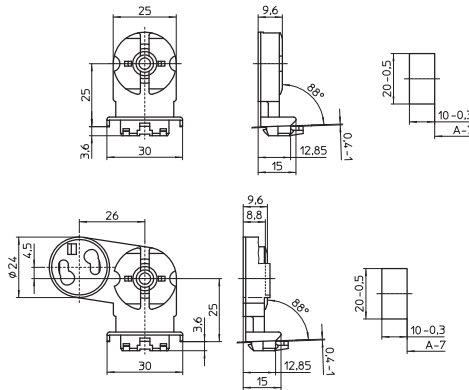

3

4

5

6

7

8

9

10

G13 Push-fit Twin Lampholders, Accessories

For fluorescent lamps T8 (T26), T12 (T38)

Casing: PC, white, rotor: PBT GF, white
 Pin support for reliable contact
 Max. permitted temperature T_m
 on the rear side of the lampholder: 110 °C

G13 twin lampholder for lamps T8

Lamp axis: 22 mm
 Distance between two lamp axes: 50 mm
 T130, nominal rating: 2/500
 Base wiring
 Push-in terminals: 0.5-1 mm²
 Push-fit foot for wall thickness 1 mm
 Weight: 14 g, unit: 400 pcs.
 Type: 22900

Ref. No.: 108984

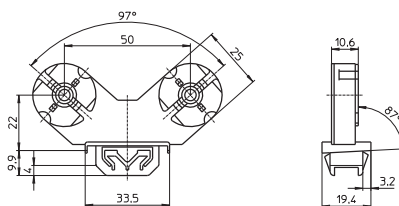

G13 twin lampholders for lamps T8 and T12

Lamp axis: 25 mm
 Distance between two lamp axes: 76 mm
 T130, nominal rating: 2/500
 Base push-in twin terminals: 0.5-1 mm² (lamp circuit)
 Base push-in terminals: 0.5-1 mm² (starter circuit)
 Push-fit foot for wall thickness 0.6-1 mm
 Weight: 21 g, unit: 200/500 pcs.
 Type: 22604/22602 without starter attachment

Ref. No.: 108816 with stop

Ref. No.: 100487 without stop

Type: 22600/22601 with starter attachment

Ref. No.: 100484 with stop

Ref. No.: 100486 without stop

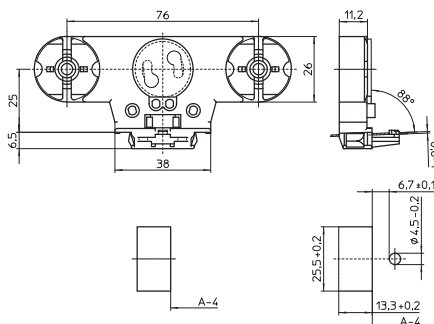

G13 twin lampholders for lamps T8 and T12

Lamp axis: 31.5 mm
 Distance between two lamp axes: 76 mm
 T130, nominal rating: 2/500
 For wiring inserts 108777/108778
 and 545261/545262
 Weight: 17 g, unit: 250 pcs.

Type: 22800/22801

Ref. No.: 108773 with starter attachment

Ref. No.: 108775 without starter attachment

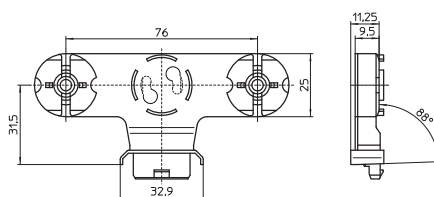

Wiring inserts with push-fit foot

For G13 twin lampholders 108773/108775

Material: PC, white

Push-in terminals: 0.5 mm²

For the automatic luminaire wiring:

IDC terminals for leads H05V-U 0.5

Weight: 5.3 g, unit: 500 pcs.

Type: 22850/22851

Ref. No.: 108777 with stop

Ref. No.: 108778 without stop

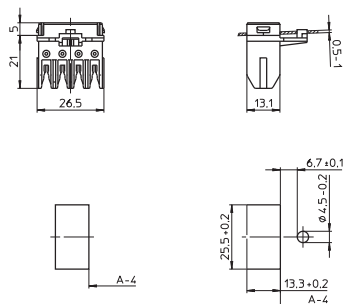

Lampholders and Accessories for T Lamps

Wiring inserts with push-fit foot

For G13 twin lampholders 108773/108775

Material: PC, white

Push-in terminals: 0.5-1 mm²

Weight: 4.4 g, unit: 500 pcs.

Type: 22860/22861

Ref. No.: 545261 with stop

Ref. No.: 545262 without stop

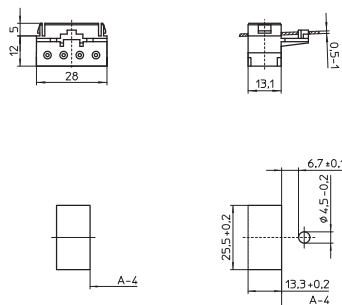

1

2

G13 Built-in Lampholders

For fluorescent lamps T8 (T26), T12 (T38)

Lampholders with integrated starter holder are equipped with big rotor and have push-in twin terminals for the lamp circuit and push-in terminals for the the starter circuit.

Pin support for reliable contact

(except for type 485)

Casing: PC, white, frontplate/rotor: PBT GF, white

Max. permitted temperature T_m

on the rear side of the lampholder: 110 °C

T-Marking acc. to IEC

G13 built-in lampholders for lamps T8 and T12

Lampholder thickness: 13 mm

T140, nominal rating: 2/500

Push-in terminals: 0.5-1 mm²

Rear split pins for wall thickness up to 1.2 mm

Weight: 4.6/5.4 g, unit: 1000 pcs.

Type: 47105/47106

Ref. No.: 509152

Ref. No.: 509154 with spring adjustment

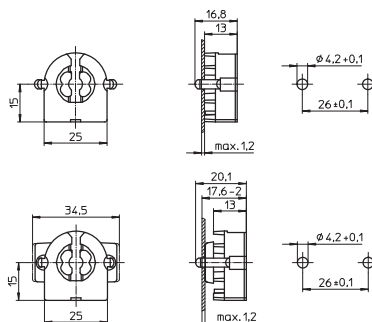

5

6

G13 built-in lampholders for lamps T8 and T12

Lampholder thickness: 9.5 mm

T140, nominal rating: 2/500

Push-in terminals: 0.5-1 mm²

Rear split pins for wall thickness up to 1.2 mm

Weight: 4.4/5.1 g, unit: 1000 pcs.

Type: 47505/47506

Ref. No.: 509162

Ref. No.: 509164 with spring adjustment

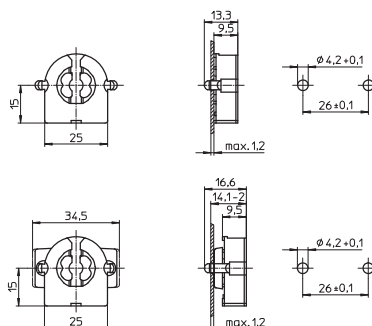

7

8

G13 built-in lampholder for lamps T8 and T12

Lampholder thickness: 10.5 mm

T140, nominal rating: 2/500

Push-in terminals: 0.5-1 mm²

Weight: 4.6 g, unit: 1000 pcs.

Type: 47304

Ref. No.: 509156

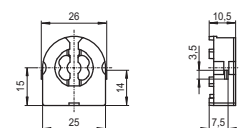

9

10

Lampholders and Accessories for T Lamps

G13 Rotoclic built-in lampholders for lamps T8 and T12
T140, nominal rating: 2/500

Base push-in terminals: 0.5-1 mm²

Fixing holes \varnothing 3.2 mm

Weight: 5 g, unit: 1000 pcs.

Type: 49100/49500

Ref. No.: 537165 lampholder thickness: 13 mm

Ref. No.: 537173 lampholder thickness: 9.5 mm

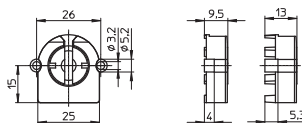

G13 built-in lampholders with spring adjustment
for lamps T8 and T12

T130, nominal rating: 2/500

Base push-in terminals: 0.5-1 mm²

Fixing holes for screws M3

Weight: 6/5.5 g, unit: 1000 pcs.

Type: 47102/47502

Ref. No.: 101681 lampholder thickness: 13 mm

Ref. No.: 101740 lampholder thickness: 9.5 mm

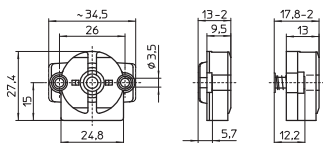

G13 Rotoclic built-in lampholders for lamps T8 and T12
T140, nominal rating: 2/500

Lateral push-in terminals: 0.5-1 mm²

Suitable for Top Test

Fixing holes \varnothing 3.2 mm

Weight: 5/4.7 g, unit: 1000 pcs.

Type: 59100/59500

Ref. No.: 537181 lampholder thickness: 13 mm

Ref. No.: 537205 lampholder thickness: 9.5 mm

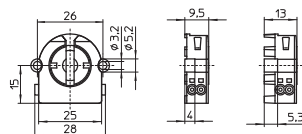

G13 built-in lampholders with starter attachment
for lamps T8 and T12

T130, nominal rating: 2/500

Base push-in terminals: 0.5-1 mm²

Fixing holes for screws M3

Weight: 8.7/10.3/8 g, unit: 1000 pcs.

Type: 47200/47402 lampholder thickness: 13 mm

Ref. No.: 101706

Ref. No.: 101708 with spring adjustment

Type: 47600 lampholder thickness: 9.5 mm

Ref. No.: 101765

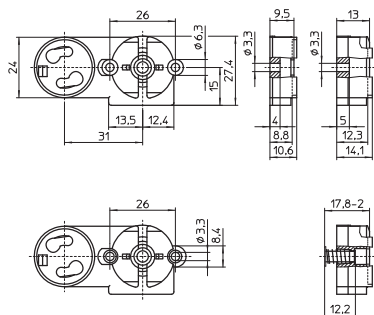

G13 Rotoclic built-in lampholders for lamps T8 and T12
T140, nominal rating: 2/500

Base push-in terminals: 0.5-1 mm²

Rear split pins for wall thickness up to 1.2 mm

Weight: 5.1/5.9/5/5.5 g, unit: 1000 pcs.

Type: 49105/49106 lampholder thickness: 13 mm

Ref. No.: 537166

Ref. No.: 537167 with spring adjustment

Type: 49505/49506 lampholder thickness: 9.5 mm

Ref. No.: 537174

Ref. No.: 537175 with spring adjustment

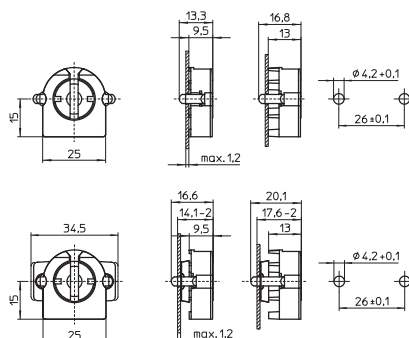

Lampholders and Accessories for T Lamps

G13 Rotoclic built-in lampholders for lamps T8 and T12
T140, nominal rating: 2/500

Lateral push-in terminals: 0.5-1 mm², suitable for Top Test
Rear split pins for wall thickness up to 1.2 mm
Weight: 5.1/5.9/5/5.5 g, unit: 1000 pcs.

Type: 59105/59106 lampholder thickness: 13 mm

Ref. No.: 537182

Ref. No.: 537183 with spring adjustment

Type: 59505/59506 lampholder thickness: 9.5 mm

Ref. No.: 537206

Ref. No.: 537207 with spring adjustment

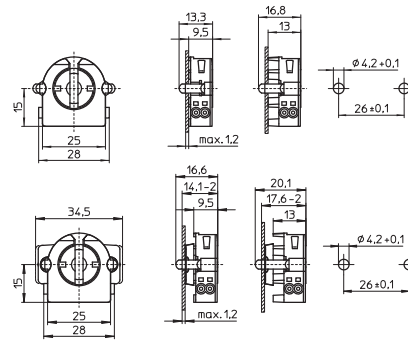

1

2

G13 built-in lampholders with starter attachment
for lamps T8 and T12, T130, nominal rating: 2/500
Base push-in terminals: 0.5-1 mm²

Rear split pins for wall thickness up to 1.2 mm
Weight: 9/9.5/8/8.5 g, unit: 1000 pcs.

Type: 47205/47206 lampholder thickness: 13 mm

Ref. No.: 101712

Ref. No.: 101716 with spring adjustment

Type: 47605/47606 lampholder thickness: 9.5 mm

Ref. No.: 101769

Ref. No.: 101773 with spring adjustment

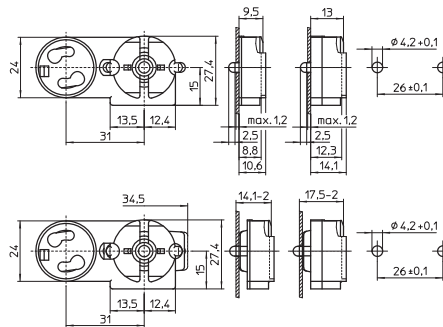

3

4

G13 built-in lampholders for lamps T8
For the automatic luminaire wiring
T130

Nominal rating: 2/500, lampholder thickness:
10.5 mm, IDC terminals for leads H05V-U 0.5
Rear split pins for wall thickness up to 1.2 mm

Weight: 5/5.5 g, unit: 1000 pcs.

Type: 48205/48206

Ref. No.: 507133

Ref. No.: 507134 with spring adjustment

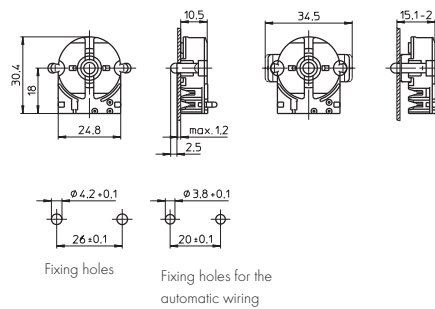

5

6

G13 built-in lampholder for lamps T8 and T12
Lampholder thickness: 10.7 mm
T130

Nominal rating: 2/500
Push-in terminals: 0.5-1 mm²

Lateral fixing clips

Weight: 4.7 g, unit: 1000 pcs.

Type: 47504

Ref. No.: 101745

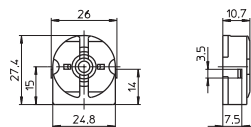

7

8

G13 lampholder

For push-fitting onto lamps T12

Lampholder thickness: 9.5 mm

Casing: PC, white, T110

Front cover plate: PBT GF, white

Nominal rating: 2/250

Push-in terminals: 0.5-1 mm²

Fixing holes for screws M3

Weight: 10.5 g, unit: 1000 pcs.

Type: 47700

Ref. No.: 101781

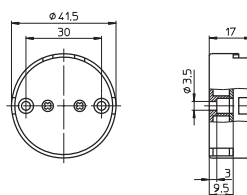

9

10

Lampholders and Accessories for T Lamps

G13 lampholder

For push-fitting onto lamps T8
 Lampholder thickness: 9.5 mm
 Casing: PC, white, T110
 Front cover plate: PBT GF, white
 Nominal rating: 2/500
 Push-in terminals: 0.5-1 mm²
 Fixing hole for screw M3
 Weight: 5.3 g, unit: 1000 pcs.
 Type: 47900

Ref. No.: 101784

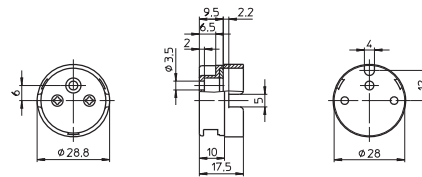

G13 lampholder with starter attachment

For push-fitting onto lamps T8
 Lampholder thickness: 9.5 mm
 Casing: PC, white, T110
 Front cover plate: PBT GF, white
 Nominal rating: 2/250
 Push-in terminals: 0.5-1 mm²
 Fixing hole for screw M3
 Weight: 8.1 g, unit: 1000 pcs.
 Type: 47920

Ref. No.: 101785

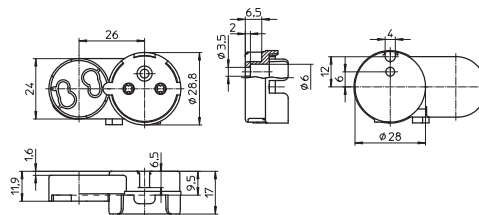

G13 built-in lampholder with lamp lock

for lamps T8 and T12
 Contacts on both sides
 Casing: PBT GF, white, T130, nominal rating: 2/500
 Screw terminals: 0.5-2.5 mm²
 Fixing holes for screws M3
 Weight: 12.9/18 g, unit: 500 pcs.
 Type: 46100/46101

Ref. No.: 101643

Ref. No.: 101647 with spring adjustment

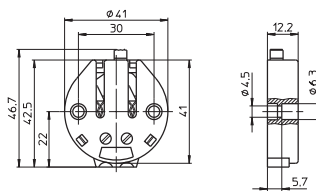

G13 built-in lampholders for lamps T8 and T12

Casing: PC, white, T110
 Nominal rating: 2/500
 Screw terminals: 0.5-2.5 mm²
 Fixing holes for screws M3
 5 rotation stops
 Weight: 9/10.6 g, unit: 1000 pcs.
 Type: 48500/48501

Ref. No.: 101787

Ref. No.: 101789 with spring adjustment

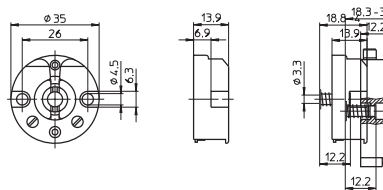

G13 Surface-mounted Lampholders

For fluorescent lamps T8 (T26), T12 (T38)

Pin support for reliable contact
(except for type 485)

Max. permitted temperature T_m
on the rear side of the lampholder: 110 °C

G13 surface-mounted lampholder for lamps T8 and T12

Lamp axis: 25.5 mm

Casing: PC, white, rotor: PBT GF, white, T130

Nominal rating: 2/500

Push-in twin terminals: 0.5–1 mm²

Fixing hole: Ø 3.8 mm

Weight: 7.2 g, unit: 500 pcs.

Type: 27722

Ref. No.: 100572

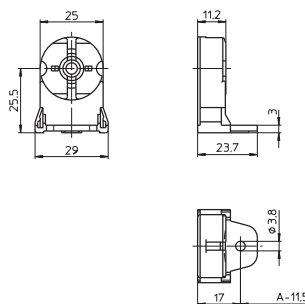

G13 surface-mounted lampholder with starter attachment for lamps T8 and T12

Lamp axis: 25.5 mm

Casing: PC, white, rotor: PBT GF, white, T130

Nominal rating: 2/500

Push-in twin terminals: 0.5–1 mm²

Fixing hole: Ø 3.8 mm

Weight: 9.5 g, unit: 500 pcs.

Type: 27822

Ref. No.: 100583

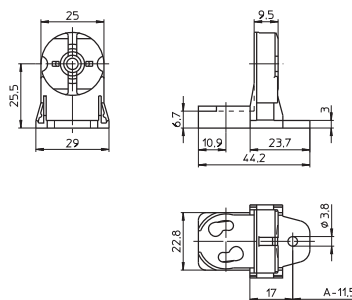

G13 surface-mounted lampholder for lamps T8

Lamp axis: 17 mm

Casing: PC, white, rotor: PBT GF, white, T130

Nominal rating: 2/250

Push-in twin terminals: 0.5–1 mm²

Fixing hole for self-tapping screw acc. to ISO 1481/7049-ST3.5-C/F

Weight: 5.4 g, unit: 1000 pcs.

Type: 27356

Ref. No.: 100551

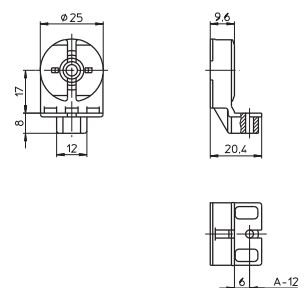

G13 surface-mounted lampholders with lamp lock for lamps T8 and T12, lamp axis: 25 mm

Contacts on both sides

Casing: PBT GF, white, T130

Screw terminals: 0.5–2.5 mm², nominal rating: 2/500

Bracket: zinc-coated polished steel

Fixing slots for screws M4

Weight: 35/36 g, unit: 500 pcs.

Type: 46102/46103

Ref. No.: 101651

Ref. No.: 101655 with spring adjustment

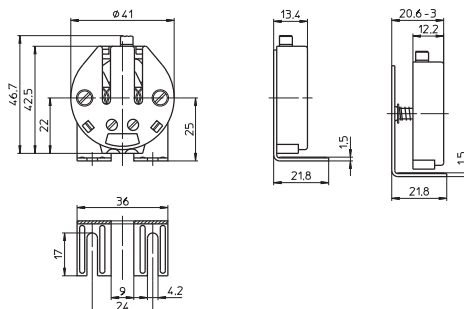

Lampholders and Accessories for T Lamps

G13 surface-mounted lampholders

for lamps T8 and T12

Lamp axis: 25 mm, casing: PC, white, T110

Screw terminals: 0.5-2.5 mm², nominal rating: 2/500

Bracket: zinc-coated polished steel

Fixing slots for screws M4

5 rotation stops

Weight: 26/28.1 g, unit: 500 pcs.

Type: 48502/48503

Ref. No.: 101791

Ref. No.: 101793 with spring adjustment

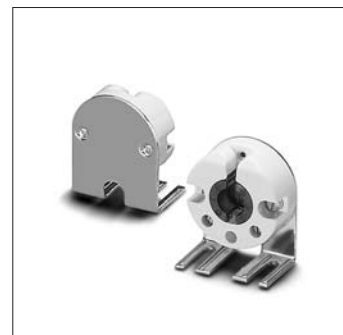
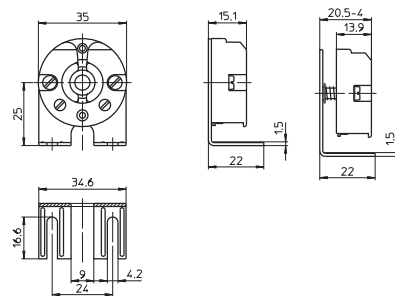

Accessories

For lampholders for fluorescent lamps T8 (T26), T12 (T38)

The luminaire manufacturer is responsible for the right choice of accessories.

Lamp supports

Fixing hole for screw M4

Weight: 4.3/6.8 g, unit: 500 pcs.

Type: 20400 for lamps T8

Ref. No.: 100442 material: zinc-coated polished steel

Type: 20401 for lamps T12

Ref. No.: 100444 material: CrNi-steel

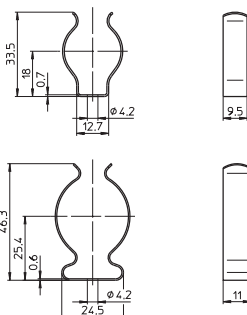

Lamp supports for lamps T8

Material: PC, crystal-clear

Fixing hole for screw M4

Weight: 2 g, unit: 1000 pcs.

Type: 20501

Ref. No.: 100448

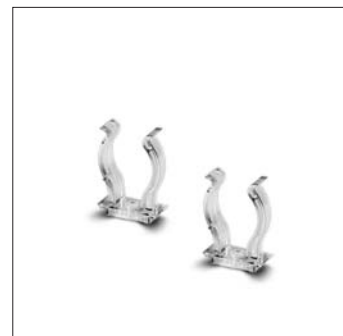
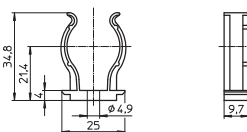

Push-fit bracket

For G13 built-in lampholder 537174, 537206

(see p. 202, 203) and starter holder 101627

and 109792 (see p. 219, 220), material: PC, white

Lamp axis optional: 46/51/56 mm

or 43 mm (lateral lamp insertion)

Push-fit foot for wall thickness 0.5-1 mm

Option for lateral or base wiring

Weight: 5.3 g, unit: 1000 pcs.

Type: 97532

Ref. No.: 105843

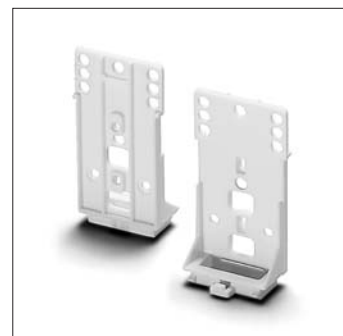
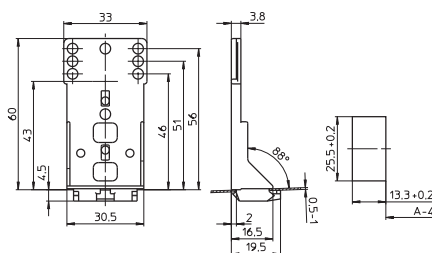

Lampholders and Accessories for T Lamps

Push-fit bracket

For G13 built-in lampholder 537181, 537166, 537174 (see p. 202), 537206 and 507133 (see p. 203)

Material: PC, grey

Lamp axis optional: 33/40/46/51/56 or 43 mm (lateral lamp insertion)

Push-fit foot for wall thickness 0.5-1 mm

Weight: 6 g, unit: 1000 pcs.

Type: 97044

Ref. No.: 108780

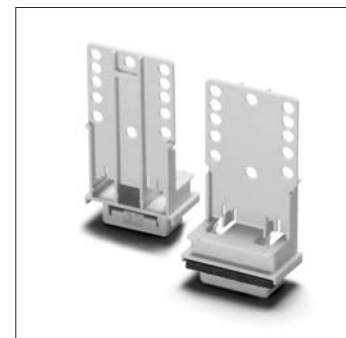
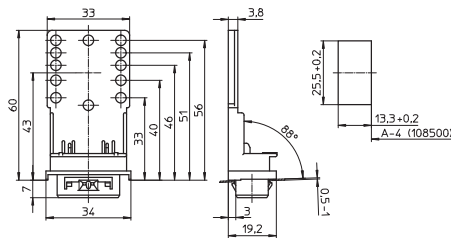

1

2

Foot gasket for degree of protection IP50

For push-fit bracket 108780

Material: EPDM, black

Weight: 0.7 g

Type: 98003

Ref. No.: 108266

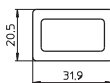

3

4

Push-fit bracket, right

For G13 built-in lampholders 101769, 537174 and 537206 (see p. 202, 203)

Material: PC, white

Lamp axis optional: 25/45 mm, distance

between two lamp axes optional: 30/35 mm

Push-fit foot for wall thickness 0.5-1 mm

Option for lateral or base wiring

Weight: 6.6 g, unit: 1000 pcs.

Type: 97533

Ref. No.: 105845

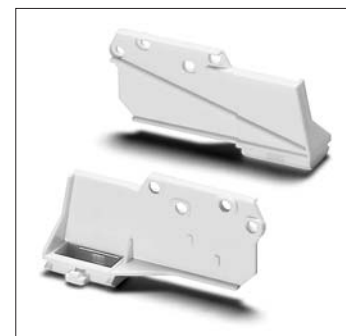
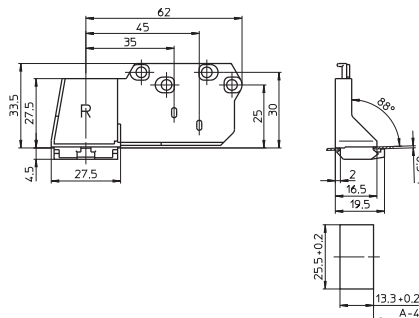

5

6

Push-fit bracket, left

For G13 built-in lampholders 537174, 537206 (see p. 202, 203)

Material: PC, white

Lamp axis optional: 25/45 mm, distance

between two lamp axes optional: 30/35 mm

Push-fit foot for wall thickness 0.5-1 mm

Option for lateral or base wiring

Weight: 6.7 g, unit: 1000 pcs.

Type: 97534

Ref. No.: 105847

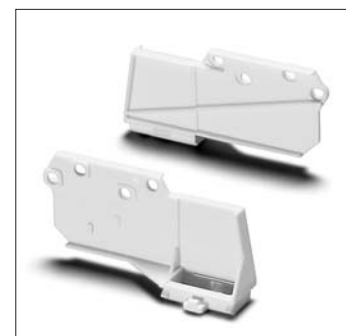
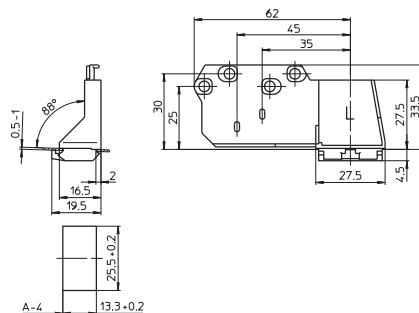

7

8

Cable holder

Material: PA, white

Push-fit foot for cut-out Ø 4 mm

for wall thickness 0.6-1.2 mm

Weight: 0.2 g, unit: 5000 pcs.

Type: 97147

Ref. No.: 109086

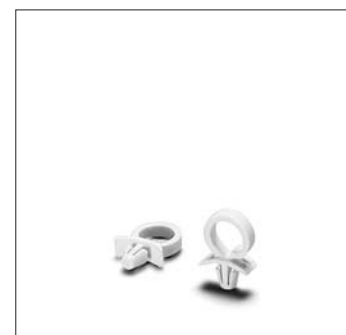
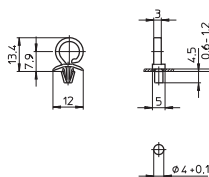

9

10

Lampholders and Accessories for T Lamps

Cable holder

For the automatic luminaire wiring
and manual wiring

Material: PC, white

Degree of protection IP50

Weight: 0.5 g, unit: 5000 pcs.

Type: 97117

Ref. No.: 108845

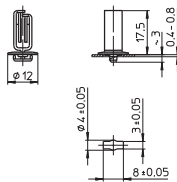

Cable holder

For the automatic luminaire wiring
and manual wiring

Material: PA, white

Weight: 2.1 g, unit: 7500 pcs.

Type: 0607

Ref. No.: 159968

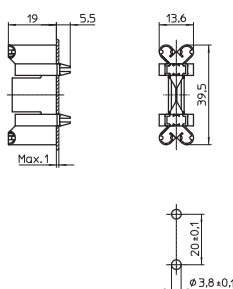

G13 Lampholders, Degree of Protection IP54

**For fluorescent lamps T8 (T26), T12 (T38)
For luminaires of protection class I and II**

Lampholders protected against dust and splashing water (IP54)
To convert luminaires from IP20 to IP54
Pin support for reliable contact
With spring adjustment

Max. permitted temperature T_m
on the rear side of the lampholder: 110 °C

G13 push-fit lampholder for lamps T8/T12
Casing: PC, white, interior part: PBT GF, white
Rotor: PBT GF, white, T140
Nominal rating: 2/500
Push-in terminals: 0.5-1 mm²
Fixing clips for wall thickness 0.7 mm
Screw rings see page 213
Weight: 17.1 g, unit: 500 pcs.
Type: 84171 system 161
Ref. No.: 107957

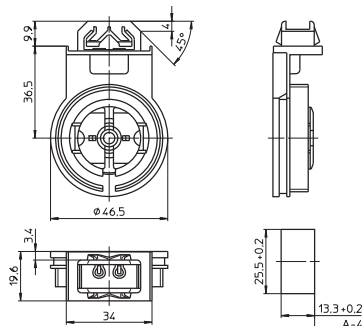

G13 push-fit twin lampholder for lamps T8/T12
Casing: PC, white, interior part: PBT GF, white
Rotor: PBT GF, white, T140
Nominal rating: 2/500
Push-in terminals: 0.5-1 mm²
Fixing clips for wall thickness 0.7 mm
Screw rings see page 213
Weight: 33.6 g, unit: 250 pcs.
Type: 84173 system 162
Ref. No.: 107959

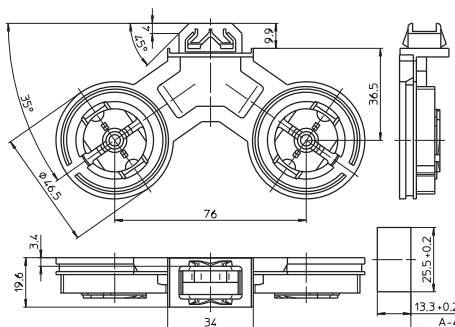

Food gasket for degree of protection IP54
For lampholder systems 161, 162
Material: EPDM, black
Weight: 0.7 g
Type: 98003
Ref. No.: 108266

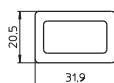

1

2

3

4

5

6

7

8

9

10

G13 Lampholders, Degree of Protection IP65/IP67

**For fluorescent lamps T8 (T26), T12 (T38)
For luminaires of protection class I and II**

Lampholders protected against dust and jet of water (IP65)
Dust and watertight lampholders (IP67)
Pin support for reliable contact with spring adjustment

Max. permitted temperature T_m on the rear side of the lampholder: 110 °C

G13 push-fit lampholders for lamps T8/T12

Casing: PC, interior part: PBT GF

Rotor: PBT GF, white, T140

Nominal rating: 2/500

Push-in terminals: 0.5-1 mm²

Fixing clips for wall thickness 1.4-2 mm

Screw rings see page 213

Weight: 17.3 g, unit: 500 pcs.

Type: 84172 system 163

Ref. No.: 107958 casing white

Ref. No.: 108666 casing grey

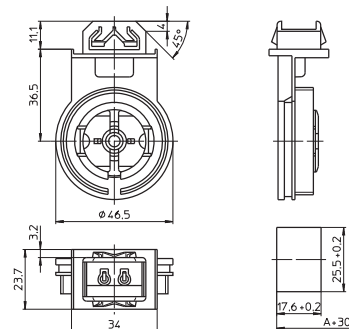

G13 push-fit twin lampholders for lamps T8/T12

Casing: PC, interior part: PBT GF

Rotor: PBT GF, white, T140

Nominal rating: 2/500

Push-in terminals: 0.5-1 mm²

Fixing clips for wall thickness 1.4-2 mm

Screw rings see page 213

Weight: 34.2 g, unit: 250 pcs.

Type: 84174 system 164

Ref. No.: 107960 casing white

Ref. No.: 108669 casing grey

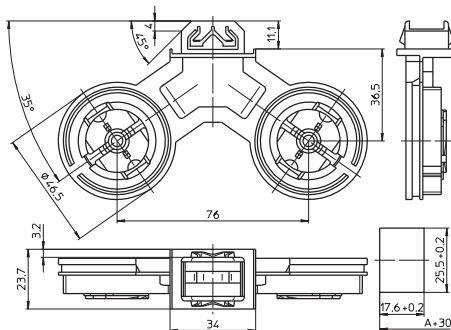

G13 push-fit lampholders for lamps T8/T12

Casing: PC, interior part: PBT GF, T140

Nominal rating: 2/500

Push-in terminals: 0.5-1 mm²

Fixing clips for wall thickness 1.4-2 mm

With slot insertion

Screw rings see page 213

Weight: 14.5 g, unit: 250 pcs.

Type: 84175 system 165

Ref. No.: 108608 casing white

Ref. No.: 108614 casing grey

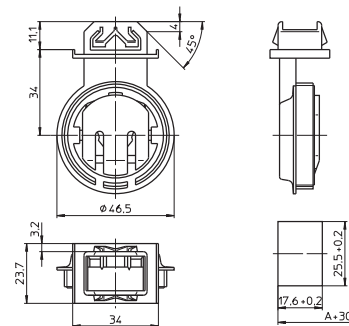

Foot gaskets

For lampholder systems 163, 164, 165

Weight: 1/1.1 g

For degree of protection IP65

Material: cellular rubber

Type: 98004

Ref. No.: 108267

For degree of protection IP67

Material: silicone, transparent

Type: 98011

Ref. No.: 504078

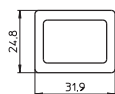

Lampholders and Accessories for T Lamps

Profiled foot gasket
 For degree of protection IP67
 For lampholder systems 163, 164, 165
 Material: EPDM, black
 Weight: 1.1 g, unit: 1000 pcs.
 Type: 98008

Ref. No.: 546254

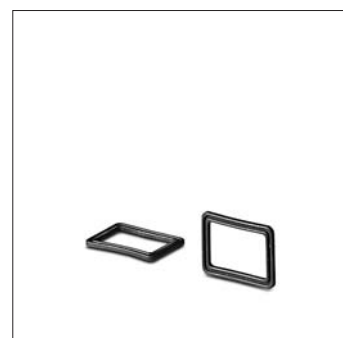
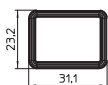

1

2

G13 lampholder for lamps T8/T12
 Casing: PC, interior part: PBT GF, T140
 Nominal rating: 2/500
 With slot insertion
 For wiring insert 108819
 Screw rings see page 213
 Weight: 15.1 g, unit: 500 pcs.
 Type: 84180 system 167

Ref. No.: 108948 casing white

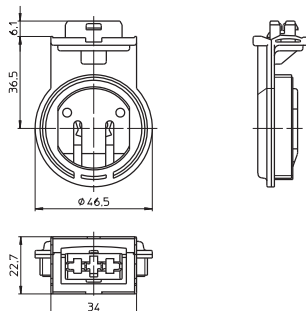

3

4

G13 twin lampholder for lamps T8/T12
 Casing: PC, interior part: PBT GF, T140
 Nominal rating: 2/500
 With slot insertion
 For wiring insert 108819
 Screw rings see page 213
 Weight: 30.6 g, unit: 250 pcs.
 Type: 84181 system 168

Ref. No.: 108994 casing white

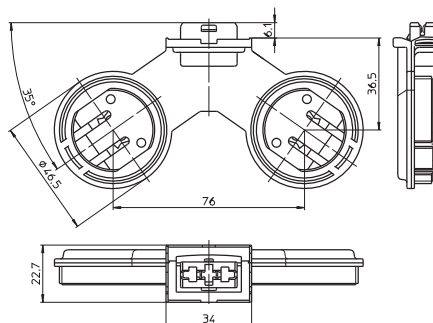

5

6

Wiring insert with push-fit foot
 For lampholder systems 167, 168
 Material: PC, grey
 Push-in terminals: 0.5 mm²
 For the automatic luminaire wiring:
 IDC terminals for leads H05V-U 0.5
 Push-fit foot for wall thickness 1.4-2 mm
 Weight: 5.1 g, unit: 500 pcs.
 Type: 22852

Ref. No.: 108819

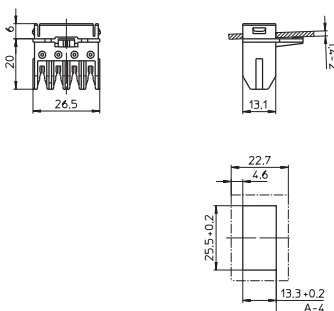

7

8

Foot gasket for degree of protection IP67
 For lampholder systems 167, 168
 Material: PE foam
 Weight: 0.5 g
 Type: 98002

Ref. No.: 108947

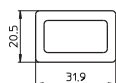

9

10

Lampholders and Accessories for T Lamps

Foot gasket, profiled shape
 For degree of protection IP67
 For lampholder systems 167, 168
 Material: EPDM, black
 Weight: 0.7 g, unit: 1000 pcs.
 Type: 98087

Ref. No.: 503773

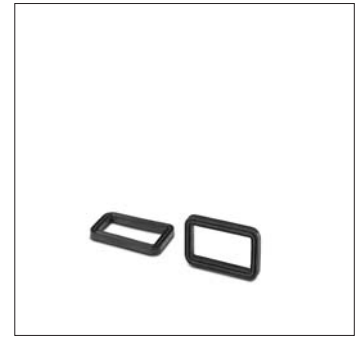
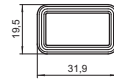

G13 lampholder for lamps T8/T12
 Casing: PC, white, interior part: PBT GF, T140
 Nominal rating: 2/500
 Screw fixing foot with tapped holes M4
 Screw rings see page 213
 With slot insertion
 Weight: 14 g, unit: 250 pcs.
 Type: 84105 system 152

Ref. No.: 521123

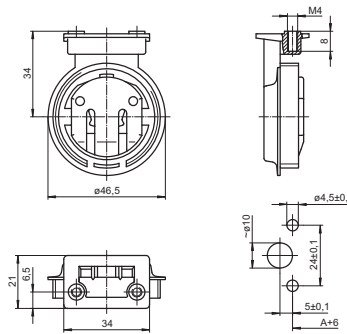

Foot gasket for degree of protection IP65/IP67
 For lampholder system 152
 Material: EPDM, black
 Weight: 1.4 g, unit: 1000 pcs.
 Type: 98085

Ref. No.: 106094

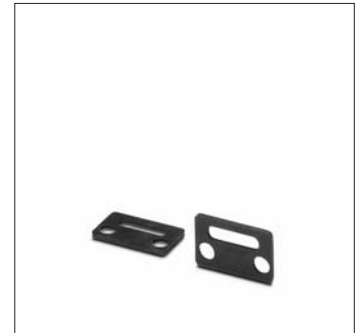
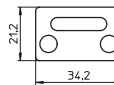

Screw Rings for G13 Lampholders, Degree of Protection IP54, IP65, IP67

For lampholder systems 152, 161, 162, 163, 164, 165, 167, 168

Screw rings

Ring: PBT GF, gasket: silicone

Weight: 17/20 g, unit: 500/250 pcs.

Type: 84122 for lamps T8

Ref. No.: 103710 white

Ref. No.: 103709 grey

Type: 84123 for lamps T12 or

for lamps T8 with protection tube \varnothing 38 mm

Ref. No.: 103712 white

Ref. No.: 103711 grey

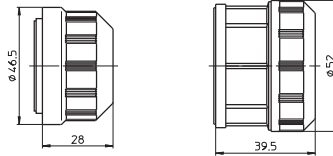

Screw rings with heat dissipator

For lamps T8 with

plastic protection tube \varnothing 38 mm

Ring: PBT GF

Gasket: silicone, shell: aluminium

Weight: 40 g, unit: 250 pcs.

Type: 84154

Ref. No.: 103744 white

Ref. No.: 103743 grey

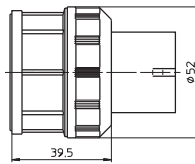

Screw rings

For protection tube \varnothing 50 mm

Ring: PBT GF

Gasket: EPDM

Weight: 43.8 g, unit: 125 pcs.

Type: 84159 not suitable for system 152

Ref. No.: 103750 white

Ref. No.: 103749 grey

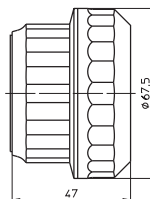

1

2

3

4

5

6

7

8

9

10

G10q Lampholders, Accessories

For fluorescent lamps T-R

G10q push-fit lampholder

Casing: PC, white, T110

Spring bracket \varnothing 32 mm: CrNi-steel

Nominal rating: 2/500

Push-in terminals: 0.5–1 mm²

Lamp axis: 23 mm

Push-fit foot for wall thickness up to 1.2 mm

Weight: 8.4 g, unit: 500 pcs.

Type: 40100

Ref. No.: 101528

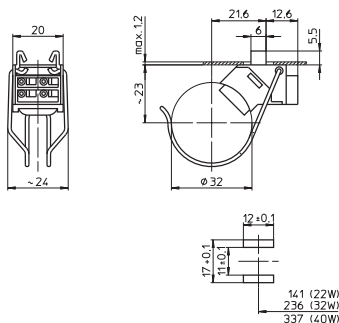

Lamp support for T-R lamps

For lampholder 101528

Material: PC, white

Spring bracket \varnothing 32 mm: CrNi-steel

Lamp axis: 23 mm

Push-fit foot for wall thickness up to 1.2 mm

Weight: 4.4 g, unit: 500 pcs.

Type: 40150

Ref. No.: 101532

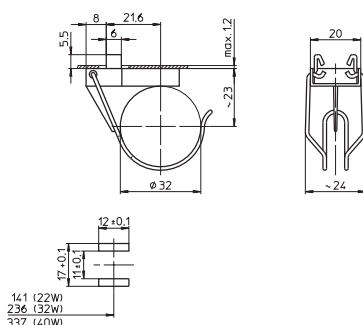

G10q surface-mounted lampholder

Casing: PC, white, T110

Spring bracket \varnothing 32 mm: CrNi-steel

Nominal rating: 2/250

Connection leads: H05V2-U 1X0.75,
max. 105 °C, length: 270 mm

Lamp axis: 35 mm

Fixing plates with tapped holes M4

Weight: 25 g, unit: 250 pcs.

Type: 58016

Ref. No.: 102409

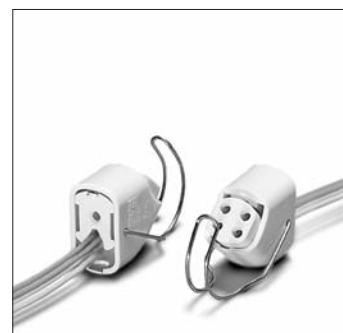
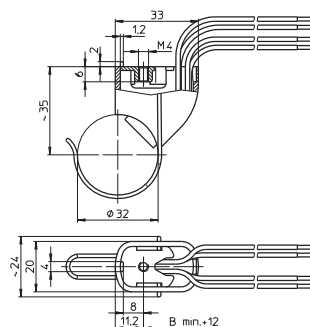

Lamp support for T-R lamps

For lampholder 102409

Material: PC, white

Spring bracket \varnothing 32 mm: CrNi-steel

Lamp axis: 35 mm

Fixing plates with tapped holes M4

Weight: 8 g, unit: 500 pcs.

Type: 58001

Ref. No.: 102407

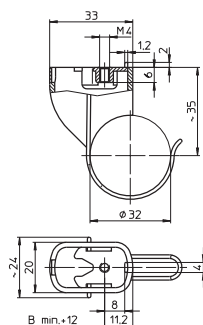

1

2

3

4

5

6

7

8

9

10

OPTIMUM
START WITH
COMPONENTS
MADE BY VS



STARTER HOLDERS AND TERMINAL BLOCKS, ACCESSORIES

Vossloh-Schwabe provides a comprehensive range of miscellaneous accessories for operating fluorescent lamps.

Starter holders

Starter holders are needed for lamp circuits operated with electromagnetic ballasts. VS provides a number of starter holders with various designs for this purpose. Almost all starter holders are made of polycarbonate and qualify for a T110 temperature rating.

Terminal blocks

Furthermore, Vossloh-Schwabe's product range also includes connection terminals, some of which feature the VDE-approved IDC method in addition to the well-known and installation-friendly push-in connectors. The connection terminals therefore make it possible to automate luminaire wiring and thus wire up several terminals using a single cable.

The range is rounded off by built-in rocker switches.

3

Starter Holders and Terminal Blocks, Accessories

Starter holders, accessories	218–221
Terminal blocks, accessories	222–224
Built-in rocker switches	225
Technical details for fluorescent lamps	226–253
General technical details	366–374
Glossary	375–377

1

2

3

4

5

6

7

8

9

10

Starter Holders, Accessories

For starters acc. to DIN VDE 0712 part 101, IEC 60155

Starter holders with central studs, suitable for luminaires of protection class II, are available on request.

Starter holder

Material: PC, white

T110, nominal rating: 2/250

Push-in terminals: 0.5-1 mm²

Rear split pins for wall thickness up to 1.2 mm

Weight: 2.1 g, unit: 1000 pcs.

Type: 02113

Ref. No.: 535131

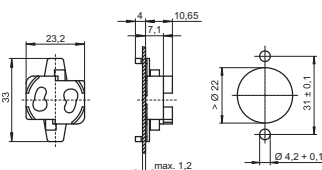

Starter holder

Material: PC, white

T110, nominal rating: 2/250

Push-in terminals: 0.5-1 mm², single-core

Front and rear split pins for wall thickness up to 1.2 mm

Rear of starter holder/luminaire: IP40

Weight: 2.8 g, unit: 1000 pcs.

Type: 02110

Ref. No.: 109784

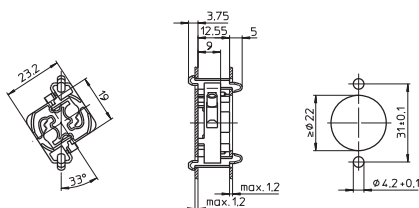

Starter holder

Material: PC, white

T110, nominal rating: 2/250

Push-in terminals: 0.5-1 mm²

Rear split pins for wall thickness up to 1.2 mm

Lateral split pins for wall thickness up to 1.25 mm

Rear of starter holder/luminaire: IP40

Weight: 3.7 g, unit: 1000 pcs.

Type: 02120

Ref. No.: 100064

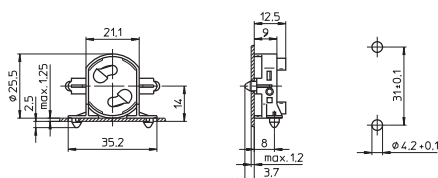

Starter holder

Material: PC, white

T110, nominal rating: 2/250

Push-in terminals: 0.5-1 mm²

Fixing holes for screws M3

Weight: 3.8 g, unit: 1000 pcs.

Type: 02150

Ref. No.: 100069

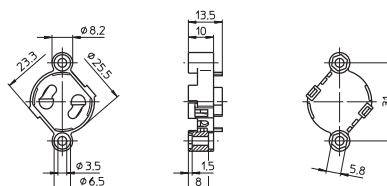

Starter Holders and Terminal Blocks, Accessories

Starter holder

Material: PC, white

T110, nominal rating: 2/250

Push-in terminals: 0.5-1 mm²

Front split pins, flat

for wall thickness 0.6-1 mm

Weight: 3.1 g, unit: 1000 pcs.

Type: 02170

Ref. No.: 106818

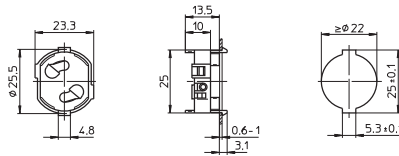

1

2

Starter holder

Material: PC, white

T110, nominal rating: 2/250

Push-in terminals: 0.5-1 mm²

Rear split pins for wall thickness up to 1.2 mm

Rear of starter holder/luminaire: IP40

Weight: 3.3 g, unit: 1000 pcs.

Type: 43000

Ref. No.: 101627

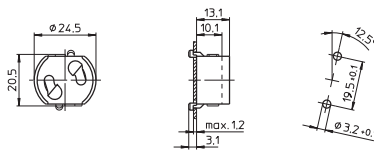

3

4

Starter holder

Material: PC, white

T110, nominal rating: 2/250

Push-in terminals: 0.5-1 mm²

Lateral split pins for wall thickness up to 1 mm

Rear of starter holder/luminaire: IP40

Weight: 3.4 g, unit: 1000 pcs.

Type: 43010

Ref. No.: 101629

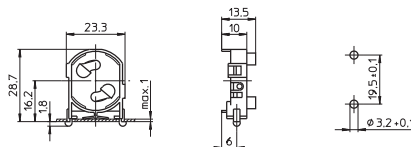

5

6

Starter holder

Material: PC, white

T110, nominal rating: 2/250

Push-in terminals: 0.5-1 mm²

Rear and lateral split pins

for wall thickness up to 1 mm

Rear of starter holder/luminaire: IP40

Weight: 3.5 g, unit: 1000 pcs.

Type: 43020

Ref. No.: 108671

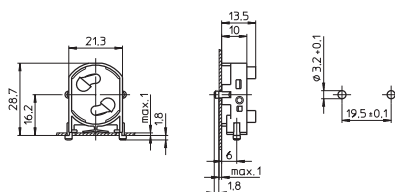

7

8

Starter holder

Material: PC, white

T110, nominal rating: 2/250

Push-in terminals: 0.5-1 mm²

Fixing holes for screws M3

Weight: 3.7 g, unit: 1000 pcs.

Type: 43100

Ref. No.: 101631

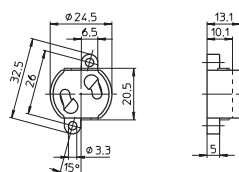

9

10

Starter Holders and Terminal Blocks, Accessories

Starter holder

Material: PC, white

T110, nominal rating: 2/250

Push-in terminals: 0.5-1 mm², single-core

Lateral split pins for wall thickness up to 1 mm

Rear of starter holder/luminaire: IP40

Weight: 3.7 g, unit: 1000 pcs.

Type: 43200

Ref. No.: 109790

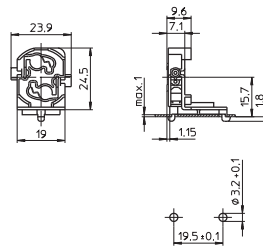

Starter holder

Material: PC, white

T110, nominal rating: 2/250

Push-in terminals: 0.5-1 mm², single-core

Rear split pins for wall thickness up to 1.2 mm

Lateral split pins for wall thickness up to 1 mm

Rear of starter holder/luminaire: IP40

Weight: 3.7 g, unit: 1000 pcs.

Type: 43210

Ref. No.: 109792

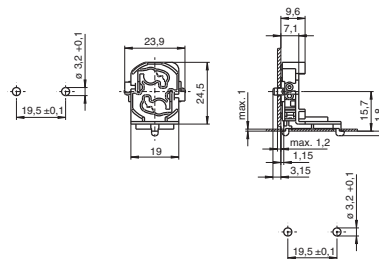

Starter holder with integrated extension piece

Material: PC, white

T110, nominal rating: 2/250

Push-in terminals: 0.5-1 mm²

Front split pins for wall thickness up to 0.8 mm

Weight: 5.4 g, unit: 1000 pcs.

Type: 43300

Ref. No.: 101636

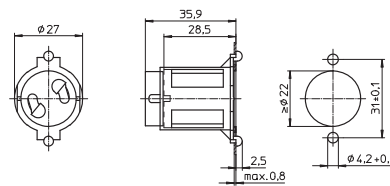

Starter holder with integrated extension piece

Material: PC, white

For the automatic luminaire wiring

T110, nominal rating: 2/250

IDC terminals for leads H05V-U 0.5

Front split pins for wall thickness up to 1 mm

Weight: 5.4 g, unit: 1000 pcs.

Type: 43500

Ref. No.: 108454

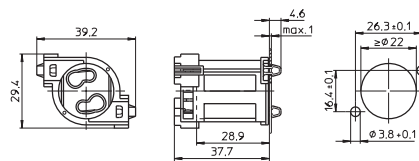

Starter holder

Material: PC, white

T110, nominal rating: 2/250

Push-in terminals: 0.5-1 mm²

For the automatic luminaire wiring:

IDC terminals for leads H05V-U 0.5

Rear split pins for wall thickness up to 1 mm

Weight: 3 g, unit: 1000 pcs.

Type: 43520

Ref. No.: 530079

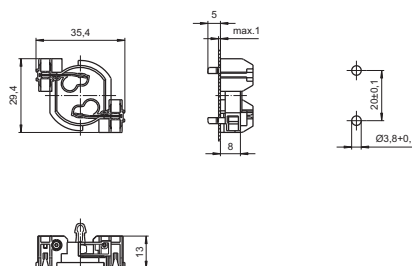

Starter Holders and Terminal Blocks, Accessories

Starter holder

Material: PA, white

T110, nominal rating: 2/250

For the automatic luminaire wiring:

IDC terminals for leads HO5V-U 0.5

Lateral split pins for wall thickness up to 1 mm

Weight: 3 g, unit: 1000 pcs.

Type: 43410

Ref. No.: 107445

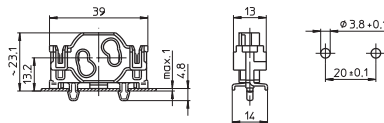

1

2

Extension piece

For front clip-in fixing into luminaire metal sheets

For use with starter holder 109784 (see p. 218)

For screw caps type 97065

Material: PC, white

Weight: 3.5 g, unit: 500 pcs.

Type: 97064

Ref. No.: 105482

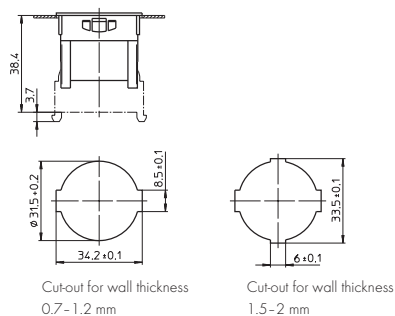

3

4

Screw caps for degree of protection IP54/IP65/IP67

For extension piece 105482

Material: PP

Gasket: EPDM cellular rubber

Weight: 3.2/4/3.2/0.3 g, unit: 500 pcs.

Type: 97065 screw cap

Ref. No.: 105483 white

Ref. No.: 109575 grey

Ref. No.: 105484 black

Type: 98086 gasket

Ref. No.: 106095

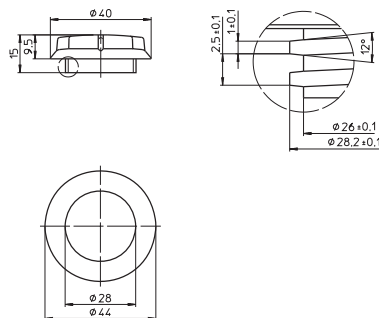

5

6

7

8

9

10

Terminal Blocks, Accessories

Suitable only for solid conductors on the secondary connection

Terminal blocks

Casing: PC, white, T85

Nominal rating: 450 V

Primary connection with release button:

push-in twin terminals 0.5-2.5 mm²/16 A

Secondary connection:

push-in twin terminals 0.5-1.5 mm²/16 A
and 0.5-2.5 mm²/16 A

Connection for X2 RFI-suppression capacitor:

0.5-0.75 mm², capacitor's pins must be insulated (stripped lead ends: 8+1 mm)

For the automatic luminaire wiring:

IDC terminals for leads H05V-U 0.5/6 A

Base split pins for wall thickness 0.6-1 mm

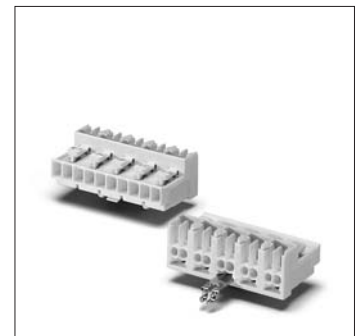
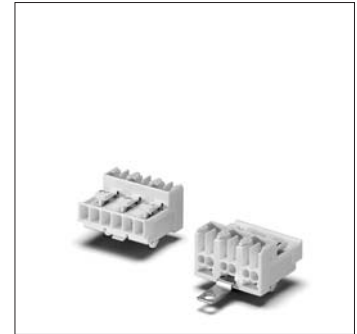
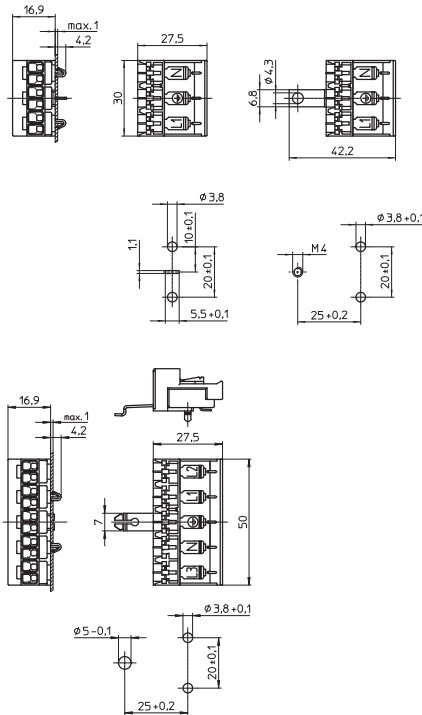

Type	Ref. No.	Number of poles	Earth-contact connection	Mark	Weight (g)	Unit (pcs.)
41500	533312	3-poles	not earthed	N, L2, L1	9.2	500
41510	533313	3-poles	earth spike	N, PE, L1	9.4	500
41520	533314	3-poles	earth strap M4	N, PE, L1	10	500
41530	534948	3-poles	earth finger	N, PE, L1	10	500
41540	533315	5-poles	not earthed	L3, L2, L4, N, L1	15.1	500
41550	533316	5-poles	earth spike	L3, L2, PE, N, L1	15.3	500
41560	533317	5-poles	earth strap M4	L3, L2, PE, N, L1	16	500
41570	534954	5-poles	earth finger	L3, L2, PE, N, L1	16	500

Push-in cord grip

For terminal blocks type 415

For leads with insulation max. Ø 10.5 mm

Conductor fixed with self-tapping screws
acc. to ISO 1481/7049-ST2.9-C/F

Material: PA, white

Weight: 2.2 g, unit: 500 pcs.

Type: 97734

Ref. No.: 535474

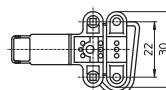
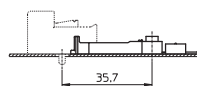

Starter Holders and Terminal Blocks, Accessories

Terminal blocks

Casing: PC, white, T85

Nominal rating: 450 V

Primary connection:

screw terminals 2.5 mm²

Secondary connection:

push-in twin terminals 1.5 mm²

(with IDC contacts: 1 mm²)

push-in terminal 0.5 mm²

For the automatic luminaire wiring:

IDC terminals for leads H05V-U 0.5

Base split pins for wall thickness 0.6-1.2 mm

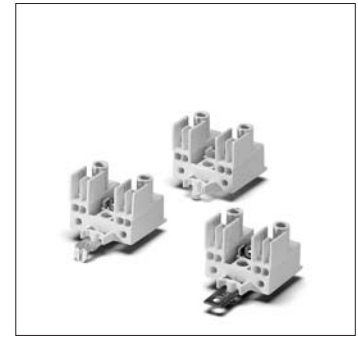
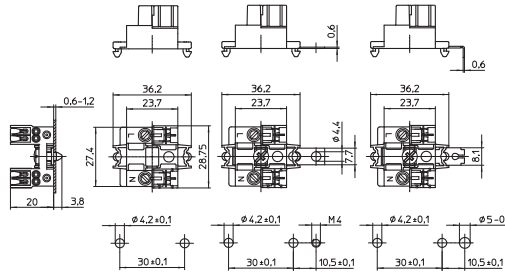

Type	Ref. No.	IDC	Type	Number of poles	Earth-contact connection	Weight (g)	Unit (pcs.)
40660	543793	no		3-poles	not earthed	5.7	1000
40662	543795	no		3-poles	earth strap M4	8.4	1000
40666	543800	no		3-poles	earth finger	8.3	1000
40661	543794	yes		3-poles	not earthed	6	1000
40663	543796	yes		3-poles	earth strap M4	8.7	1000
40667	547801	yes		3-poles	earth finger	8.6	1000

Terminal blocks with fuse holder

Material: PC, white, T70

nominal rating: 250 V

Primary connection: screw terminals 2.5 mm²

Secondary connection:

push-in twin terminals 1.5 mm²

(with IDC contacts: 1 mm²)

push-in terminal 0.5 mm²

For the automatic luminaire wiring:

IDC terminals for leads H05V-U 0.5

With retaining clip for fuses 5x20 mm

With integrated fuse on request

Base split pins for wall thickness 0.6-1.2 mm

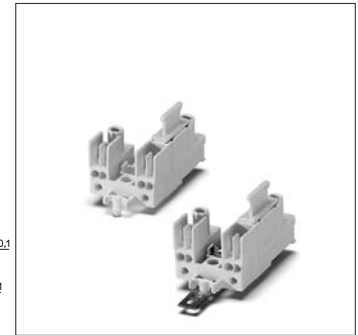
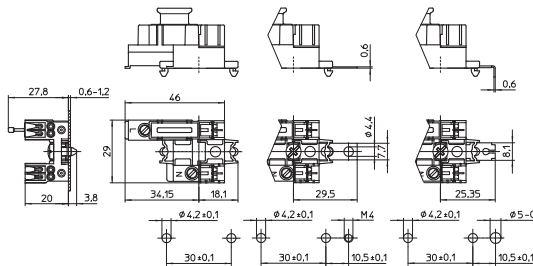

Type	Ref. No.	IDC	Type	Number of poles	Earth-contact connection	Weight (g)	Unit (pcs.)
40670	543802	no		3-poles	not earthed	8.7	1000
40672	543805	no		3-poles	earth strap M4	11.5	1000
40676	543809	no		3-poles	earth finger	14.1	1000
40671	543803	yes		3-poles	not earthed	9.0	1000
40673	543806	yes		3-poles	earth strap M4	11.8	1000
40677	543810	yes		3-poles	earth finger	14.4	1000

Starter Holders and Terminal Blocks, Accessories

Terminal blocks

Casing: PC, grey, T85

Nominal rating: 450 V

Primary connection:

screw terminals 2.5 mm²

Secondary connection:

push-in twin terminal 1.5 mm²

(with IDC contacts: 1 mm²)

push-in terminal 0.5 mm²

For the automatic luminaire wiring:

IDC terminals for leads H05V-U 0.5

Base split pins for wall thickness 0.6-1.2 mm

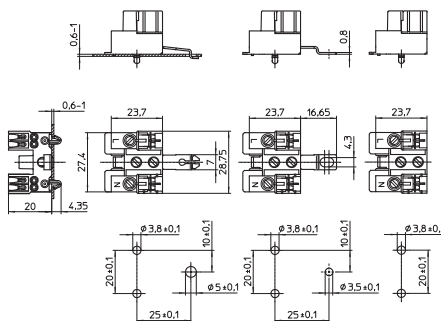

Type	Ref. No.	IDC	Type	Number of poles	Earth-contact connection	Weight (g)	Unit (pcs.)
40560	543770	no		3-poles	not earthed	8	1000
40562	543772	no		3-poles	earth strap M4	8.7	1000
40566	543777	no		3-poles	earth finger	8.8	1000
40561	543771	yes		3-poles	not earthed	8.3	1000
40563	543773	yes		3-poles	earth strap M4	9	1000
40567	543778	yes		3-poles	earth finger	9.1	1000

Terminal blocks with fuse holder

Material: PBT, grey, T70

Nominal rating: 250 V

Primary connection: screw terminals 2.5 mm²

Secondary connection:

push-in twin terminals 1.5 mm²

(with IDC contacts: 1 mm²)

push-in terminal 0.5 mm²

For the automatic luminaire wiring:

IDC terminals for leads H05V-U 0.5

With retaining clip for fuses 6x25 mm

With integrated fuse on request

Base split pins for wall thickness 0.6-1.2 mm

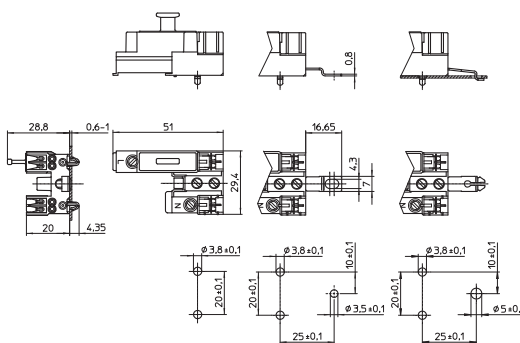

Type	Ref. No.	IDC	Type	Number of poles	Earth-contact connection	Weight (g)	Unit (pcs.)
40570	543781	no		3-poles	not earthed	11	500
40572	543783	no		3-poles	earth strap M4	11.7	500
40576	543787	no		3-poles	earth finger	11.8	500
40571	543782	yes		3-poles	not earthed	11.3	500
40573	543784	yes		3-poles	earth strap M4	12	500
40577	543788	yes		3-poles	earth finger	12.1	500

Built-in Rocker Switches

Built-in rocker switch 1-pole
For cut-out 16x26 mm
Casing: PC, white, T100
Contact pillar and rocker: PBT, white
Terminal: nichrome steel
Nominal rating: 6(2)/250~
Push-in terminals: 0.5-1 mm²
Lateral fixing clips for wall thickness 0.6-1 mm
Weight: 7.2 g, unit: 500 pcs.
Type: 20200
Ref. No.: 100437

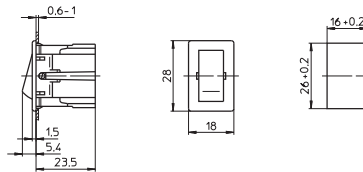

1

2

3

4

5

6

7

8

9

10

3

Components for Fluorescent Lamps

Electronic ballasts	227–241
Assembly instructions for mounting and installing – Electronic ballasts	228–235
DALI system information	235–237
Circuit diagrams – Electronic ballasts	238–241
Electromagnetic ballasts	241–245
Assembly instructions for mounting and installing – Electromagnetic ballasts	242–245
Circuit diagrams – Electromagnetic ballasts	245
Connection terminals	246
Lampholders for fluorescent lamps	247
Lamp table	248–250
Key to lamp designations	250
Energy efficiency classification	251–253
General technical details	366–374
Glossary	375–377

1

2

3

4

5

6

7

8

9

10

Ballasts for fluorescent lamps

The operation of a fluorescent lamp depends on a ballast that stabilises the lamp's preheat current after connection to the mains and, in conjunction with the starter, also supplies the required lamp ignition voltage after preheating. After ignition, the ballast then serves to limit the lamp current. As fluorescent lamps are characterised by a negative characteristic current-voltage curve, lamp current stabilisation is essential with regard to both the lamp's stable operation and a long service life, which is also dependent on compliance with the starting conditions (preheat current and ignition voltage). Unfavourable starting conditions cause damage to the electrodes every time the lamp is started and thus reduce the lamp's service life. Furthermore, care should be taken to prevent crossdischarge in the electrode area during preheating, which also shortens lamp service life.

Electromagnetic (inductive) ballasts have to be operated in conjunction with starters for lamp ignition and capacitors for blind current compensation. In addition, capacitors for RFI suppression will also be required for certain circuits. Electronic ballasts do not require any additional components.

Electronic ballasts (EB)

VS electronic ballasts are designed for mains voltages of 220 V to 240 V (exceptions are devices for the North American market where the nominal mains voltage is 120 V or 277 V) and are used to operate fluorescent lamps at high frequencies. The lamps are ignited with an internally generated ignition voltage, thereby removing the need for an external starter. The power factor (λ) > 0.95 also removes the need for compensation, unlike with electromagnetic ballasts. The only exceptions are low-output ELXs models, which attain a power factor of 0.6. Luminaires fitted with electronic ballasts are characterised by low energy consumption as they draw substantially less system power than conventional, inductive applications. This is firstly because the lamp consumes less power to achieve the same luminous flux and secondly because the internal loss of an electronic ballast only amounts to approx. 8% to 10% of the lamp's output. Furthermore, thanks to their modern circuitry, the power input of VS electronic ballasts remains constant even in the event of mains voltage fluctuations, thus ensuring permanently low energy consumption.

VS electronic ballasts permit a broad range of applications. For instance, the VS product range includes many ballast types for multiple lamp operation. These ballasts reduce installation and component costs and thus enable particularly efficient luminaires. Twin-lamp electronic ballasts permit so-called master-slave operation. The lamps of two single-lamp luminaires are operated by a twin-lamp electronic ballast that is built into the so-called master luminaire. The lamp of the slave luminaire is electrically connected to the electronic ballast.

Multi-lamp electronic ballasts also provide an interesting advantage in that several lamps of different ratings can be connected. Electronic ballasts of this kind simplify storage and logistics.

1

2

3

4

5

6

7

8

9

10

The use of electronic ballasts makes a lighting system both more convenient and efficient to operate:

- reduced power consumption (up to 30%) at undiminished light output
- 50% longer service life
- stabilised lamp output
- overvoltage protection
- no stroboscopic effect
- flicker-free lamp start
- no need for a starter or capacitor
- low wiring effort
- no radiated electromagnetic interference
- low self-heating due to minimal power loss
- automatic shutdown of defective lamps
- automatic restart once the lamp has been changed (except ELXe series)

Vossloh-Schwabe electronic ballasts are developed on the basis of the latest technological and component standards and are produced using state-of-the-art technology, whereby consideration is taken of our customers' quality standards in our quality assurance system.

Assembly Instructions for Electronic Ballasts

For mounting and installing of electronic ballasts for fluorescent lamps

Mandatory regulations

EN 61347-1	Lamp controlgear – part 1: general and safety requirements
EN 61347-2-3	Lamp controlgear – part 2-3: particular requirements for a.c. supplied electronic ballasts for fluorescent lamps
EN 60929	AC-supplied electronic ballasts for tubular fluorescent lamps
DIN VDE 0100	Erection of low voltage installations
EN 60598-1	Luminaires – part 1: general requirements and tests
EN 61000-3-2	Electromagnetic compatibility (EMC) – part 3: maximum values – main section part 2: maximum values for mains harmonics (device input current up to and including 16 A per conductor)
EN 55015	Maximum values and methods of measurement for RFI suppression in electrical lighting installations and similar electrical appliances
EN 61547	Installations for general lighting purposes – EMC immunity requirements

Descriptions of VS electronic ballasts (EBs)

ELXc ballasts (warm start)

In contrast to the ELXs series, ELXc ballasts have a power factor of better than 0.95 and cover the complete capacity range.

ELXc ballasts ensure the lamp is started following a defined lamp electrode preheating period of approx. 1–2.5 seconds using a fixed ignition voltage. This particularly gentle lamp start makes over 20,000 lamp starts possible. ELXc ballasts should be used for applications with high switching frequencies (e.g. hotels or offices) where energy savings as well as low maintenance costs are desired. The average service life of these ballasts totals 50,000 hours with a failure rate of $\leq 0.2\%$ per 1,000 operating hours. The average life of the series ECO-EffectLine: 30,000 hours and New T5 EffectLine: 50,000 hours with a failure rate of $\leq 0.2\%$ per 1,000 operating hours.

ELXd ballasts (dimnable)

These are warm start ballasts with an additional dimming function that is controlled via an interface fitted to the ballast. The interface of these ballasts can be either analogue (1–10 Volt) or digital (DALI; PUSH); the interface enables lighting to be ideally adjusted to suit the given need. Control components can also be used as long as they comply with the respective standard (Annex to IEC/EN 60929). The power factor for these ballasts is > 0.95 at 100% lamp operation. When using ELXd ballasts in a lighting system, an energy saving of 75% can be achieved if, for instance, the control inputs of the ballasts are coupled with movement detectors and light sensors. The average service life of these ballasts totals 50,000 hours with a failure rate of $\leq 0.2\%$ per 1,000 operating hours.

To guarantee trouble-free operation and a long service life of the various types of electronic ballast, attention should be paid to the regulations and mounting instructions (page 228–235). In addition, the installation instructions for lighting systems must be observed when installing luminaires with electronic ballasts.

Mounting and installation instructions can be obtained from Vossloh-Schwabe on request or can be found online at www.vossloh-schwabe.com.

1

2

3

4

5

6

7

8

9

10

Mechanical mounting

Surface	Solid, flat surface for good heat dissipation required. Avoid mounting on protruding surfaces.
Mounting location	Electronic ballasts must be protected against moisture and heat. Installation in external luminaires: water protection rate of ≥ 4 (e.g. IP54 required)
Fastening	With M4 screws in the designated holes
Heat transfer	If the ballast is destined for installation in a luminaire, sufficient heat transfer must be ensured between the ballast and the luminaire casing. Electronic ballasts should be mounted with the greatest possible clearance to heat sources or lamps. During operation, the temperature measured at the t_c point of the ballast must not exceed the specified maximum value.

Supplement for independent electronic ballasts

Mounting position	Any
Clearance	Min. of 0.10 m from walls, ceilings, insulation Min. of 0.10 m from other electronic ballasts Min. of 0.25 m from sources of heat (lamp)
Surface	Solid; device must not be allowed to sink into insulation materials

Technical specifications

Operating voltage range	AC: 220 to 240 V ($\pm 10\%$) DC: please observe the specifications on the individual product pages
Ignition time	ELXe ballasts $t < 0.5$ seconds (instant start)
Preheat time	ELXc, ELXs and ELXd ballasts $t = 0.5$ or 1.5 to 2.5 seconds (warm start)
Leak current	≤ 0.5 mA per electronic ballast

Product features

Overheating	VS EBs for fluorescent lamps are not protected against overheating
Overvoltage protection	AC: up to 48 hours at $U_{NAC} = 320$ V DC: no disorders occur with input voltages of up to $U_{NDC} 285$ V. U_{NDC} voltages in excess of 288 V destroy the ballast.
Shutdown of defective lamps	During starting operation, the electronic ballast will detect whether a lamp is connected. If no lamp is present, the ballast will cancel the starting operation. Deactivated lamps or interrupted electrodes are detected and lead to the high-frequency supply being switched off after an unsuccessful ignition attempt. Changing a lamp during operation will lead to the high-frequency supply being switched off.

EOL effect Up to now, it has not been possible to conclusively reproduce the end-of-life effect under laboratory conditions. However, it can be qualitatively described for fluorescent lamps as follows: when the emitter material of the cathode (i.e. the filament in conventional bi-pin lamps) has been fully consumed or has otherwise lost its emitting power, the emission of electrons is hampered, which leads to a voltage drop at the cathode. Frequent cold starts accelerate active emitter loss.

Operating a lamp with a constant current (an electronic ballasts (EB) provides a near-constant current) results in high dissipation losses that also cause the lamp base and lampholder to heat up and can even cause damage to both. This is often referred to as the EOL effect; from an electrical point of view, this is manifested in the so-called "partial rectifier effect".

The EOL cut-out ensures that a ballast is safely switched off and the lamp base does not overheat at the end of a lamp's service life.

EN 61347-2-3 (A1:2004) describes three possible tests.

The first are now in widespread use and are described in more detail here.

The third test is not conducted at VS.

1. EOL Test 1 (61347-2-3:2000 + A1:2004 + A2:2006 17.2)

Asymmetric pulse test

2. EOL Test 2 (61347-2-3:2000 + A1:2004 + A2:2006 17.3)

Asymmetric power test

3. EOL Test 3 (61347-2-3:2000 + A1:2004 + A2:2006 17.4)

Exposed filament test

The first two tests attempt to simulate the rectifier effect:

- Test 1 pulse switching of rectifying effect
- Test 2 by applying a DC voltage that is constantly higher than required by the lamp.

VS EBs are capable of suitably assessing the altered voltage signal in comparison to normal operation so as to meet EOL requirements.

Protection against transient mains peaks

Values are in compliance with EN 61547 (interference immunity)

(1 kV for AC and 0.5 kV for DC and control conductors).

Electrical installation

Wiring

The wiring between the mains, electronic ballast and lamp must comply with the respective circuit diagram. Note: with ELXe models, one side of the lamp electrode is never connected to the electronic ballast.

The electronic ballast must be earthed using a toothed washer or similar (protection class I, ignition help, compliance with RFI/BCI standards).

To ensure compliance with RFI-suppression limits, mains conductors should not be wired in parallel to high-frequency carrying lamp conductors; maximum clearance should be ensured and all conductors marked with an * must be kept short. As a general rule, a maximum conductor length should not be exceeded when using conventional conductors (see table on page 239-241 for precise details). Luminaire must be tested for compliance with the RFI suppression limits stipulated by EN 55015.

Conductors must not exceed 3 m in length in the event of master-slave operation.

Dimmable electronic ballasts are unsuitable for master/slave operation.

1

2

3

4

5

6

7

8

9

10

Through-wiring of mains voltage

ELXc 257.836 (188400) devices permit through-wiring of mains voltage

The following list specifies the maximum No. of devices that may be connected to the first device:

- 2 x 57 W = max. 3 devices
- 2 x 42 W = max. 4 devices
- 2 x 32 W = max. 5 devices
- 2 x 26 W = max. 7 devices

Mains power can be through-wired with the following devices:

- ELXc 213.874: max. 39 devices
- ELXc 218.875: max. 31 devices
- ELXc 142.876: max. 23 devices
- ELXc 242.877: max. 11 devices

The number of devices always refers to maximum-load operation. In addition, the maximum number of devices per installed automatic fuse must be strictly observed.

It is permissible to connect the protective conductor of the ballast by attaching the ballast to metal conductors that are connected to the protective conductor. In doing so, care must be taken to ensure the protective conductor is contacted in accordance with EN 60598. If, however, a ballast is fitted with a connection terminal for a protective conductor without through-wiring and if this is to be used to connect the protective conductor, this connection terminal may only be used for the ballast itself.

Cord grip

EBs with cord grip can be used with the following conductors, for instance:

Designation	Lead type
Mains lead	H03VV-F 3X0.75 mm ² or NYM 3X1.5 mm ²
Control lead	H03VV-F 2X0.5 mm ²
Mains and control lead in one lead	H03VV-F 5X0.75 mm ²
Lamp lead	H05VV-F 4X1 mm ² or 5X1 mm ²

Connection terminals for automatic luminaire wiring (ALF connections)

- Use copper (not stranded) wire
- Required diameter for push-in connection 0.5-1 mm²
- Stripped lead length 8-9 mm
- Required diameter for IDC 0.5 mm², max. Ø 2 mm including insulation, no wire stripping required; mounting requires a special tool

Push-in terminals

The integrated terminals can be used with flexible or rigid leads with a cross-section of 0.5-1.5 mm². The stripped lead length ranges between 8.5-9.5 mm for a 3.5 mm terminal grid.

Error current

Impulse-resistant leak-current protection must be installed. Distribute the luminaires to phases L1, L2 and L3; install tri-phase FI switches. If permissible, install FI switches with 30 mA leak current; connect no more than 15 luminaires as FI switches can be triggered at half the leak current value.

Tri-phase connection of luminaires with EB

- Prior to operating newly installed lighting systems: check the mains voltage is appropriate to the electronic ballast's mains voltage range (AC, DC).
- The N-type conductor must be properly connected to all luminaires or ballasts.
- Conductors can only be connected or disconnected if the ballast is disconnected from the mains. Attention: N-type conductors must never be disconnected individually or as the first element.
- Insulation resistance test: from L to PE (L and N must not be connected)
- The neutral conductor must be reconnected after completion of the test.

Power factor/compensation

Luminaires with electronic ballasts do not require compensation:
power factor ≥ 0.95 .

Selection of automatic cut-outs

Dimensioning automatic cut-outs

High transient currents occur when an EB is switched on because the capacitors have to load. Lamp ignition occurs almost simultaneously. This also causes a simultaneous high demand for power. These high currents when the system is switched on put a strain on the automatic conductor cut-outs, which must be selected and dimensioned to suit.

Release reaction The release reaction of the automatic conductor cut-outs comply with VDE 0641, part 11, for B and C characteristics.

No. of electronic ballasts (see the table on pages 239–241)

The maximum number of VS ballasts applies to cases where the devices are switched on simultaneously. Specifications apply to single-pole fuses. The number of permissible ballasts must be reduced by 20% for multi-pole fuses. The considered circuit impedance equals 400 m Ω (approx. 20 m of conductor [2.5 mm²] from the power supply to the distributor and a further 15 m to the luminaire). Doubling circuit impedance to 800 m Ω increases the possible number of ballasts by 10%.

EB output voltage Electronic ballasts bear the information "U_{OUT}" on their type plates. All subsequently connected components must be designed for this EB output voltage. When using T5 lamps, any components connected to the output side of the EB must be approved for a voltage of ≥ 430 V (especially lampholders). This also applies to dimmable T5 EBs.

Lamps and dimmed operation

For lighting systems with dimmable electronic ballasts, Vossloh-Schwabe recommends that fluorescent lamps always be replaced as a full complement to maintain uniform lighting levels and colour impressions. New lamps must be burnt in at maximum brightness for approx. 100 hours.

Without restrictions, VS electronic ballasts can be used to operate ECO T5 fluorescent lamps (except for with types ELXc 135.856 and ELXc 235.857) and T8 fluorescent lamps. A two-lamp dimmable electronic ballast can only be used with lamps of a single lamp manufacturer. The following EBs are restricted in their suitability for dimmer operation of amalgam lamps: ELXd 118.802, 218.803, 142.806, 242.807.

Dimming interface

DC 1–10 V according to EN 60929 with power source 0.5 mA (protected in the event of mains voltage connection); designed to enable connection of control and regulation units.
Dimming range: 3–100% of lamp power

DALI (Digital Addressable Lighting Interface) dimming interface

Polarity reversible dimmer interface – protected in accordance with EN 60929 given mains voltage supply – for connecting control devices that work according to the standard digital protocol. Dimming range: 1–100% of the lamp's rating

Potential interference with IR systems

Operating lamps at frequencies of 20 to 50 kHz can cause interference with infrared systems (remote controls, sound transmission, personal pager systems). Countermeasures: optical filters, switching to infrared systems with higher carrier frequencies (over 400 kHz).

1

2

3

4

5

6

7

8

9

10

Electromagnetic Compatibility (EMC)

Vossloh-Schwabe's electronic ballast range was developed in accordance with valid EMC standards (interference, interference immunity and mains harmonics) and specially designed to ensure safe compliance with the limiting values.

It is assumed that any remarks regarding conductor wiring and conductor length in the instructions for installing electronic ballasts in luminaires or for independent ballasts will be observed.

Vossloh-Schwabe electronic ballasts are also tested in commercially available luminaires in addition to the CISPR 30 sample luminaires.

Mains harmonics: the maximum values laid down in EN 61547 (Interference Immunity) are satisfied.

Additional information

Information on the installation of electronic ballasts for optimising EMC

To ensure good radio interference suppression and the greatest possible operating safety, the following points should be observed when installing electronic ballasts:

- Conductors between the EB and the lamp (HF conductors) must be kept short (reduction of electromagnetic interference). High-potential lamp conductors must be kept as short as possible, in particular with tubular lamps. Lamp conductors of this kind are labelled with an * in the wiring diagram on the type plate (see page 239–241).
- Mains and lamp conductors must be kept separate and if possible should not be laid in parallel to one another. The distance between HF and mains conductors should be as large as possible, ideally > 5 cm. (This prevents the induction of interference between the mains and lamp conductors.)
- The mains conductor within the luminaire must be kept short (to reduce the induction of interference).
- Devices must be properly earthed. EBs require secure contacts to the luminaire casing or must be earthed using a PE connection. This PE connection should be effected using an independent conductor to achieve better dissipation of the leak current. EMC improves at frequencies greater than 30 MHz.
- The mains conductor must not be laid too close to the EB or the lamp (this is especially important in the event of through-wiring).
- Mains and lamp conductors must not be crossed. Should this be impossible to avoid, conductors should be crossed at right angles to one another to avoid inducing interference between mains and HF conductors.
- Should conductors be wired through metal parts, such conductors must always be additionally shielded (e.g. with an insulating sleeve or grommet).

Temperature

Reference point temperature t_c

The safe operation of electronic ballasts is dependent on the maximum permissible temperature not being exceeded at the measuring point. Vossloh-Schwabe has determined a casing temperature measuring point – $t_{c \text{ max}}$ – on all EB casings. To avoid shortening the service life or diminishing operating safety, the stipulated maximum temperature must not be exceeded at this t_c point. This point is determined by testing the convertor during normal, IEC-standardised operation at the specified ambient temperature (t_a), which is also indicated on the type plate. As both the design-related ambient temperature and the ballast's inherent heat, as determined by the installed load, are subject to great variation, the casing temperature should be tested at the t_c point under real installation conditions.

Ambient temperature t_a

The ambient temperature – as specified on every EB – denotes the permissible temperature range within the luminaire.

Reliability and service life

If the max. temperature at the t_c reference point (as specified on the type plate and the technical documentation of the ballast) is not exceeded, the defined service life can be expected to be achieved, assuming a switching cycle of 165 minutes on and 15 minutes off.

See page 229 for service life details regarding the various electronic ballast families.

Emergency lighting

All Vossloh-Schwabe EBs that are suitable for DC voltage operation can be used in emergency lighting systems. Consideration must, however, be taken of system requirements.

VS Dimmable Electronic Ballasts

Vossloh-Schwabe's range of electronic ballasts is rounded off by dimmable ballasts for fluorescent lamps. The standardised interfaces "1-10 V" and "DALI" are used for this purpose. Coupled with sensors, electronic ballasts fitted with a "1-10 V" interface make it easy to create intelligent luminaires and room lighting systems, whereby the luminaires are "programmed" via the wiring to the control units, i.e. via the hardware.

The digital interface "DALI" (Digital Addressable Lighting Interface) constitutes a further development of the "1-10 V" analogue interface. This digital interface was jointly developed by leading manufacturers of electronic ballasts in order to create a uniform standard for the lighting industry. The uniform interface and telegram definition dictates the function of a DALI operating device or DALI consumer and ensures exchangeability of operating devices made by various manufacturers.

Each VS DALI ballast is additionally fitted with the so-called PUSH function. The data input DA (DALI & PUSH) is used as a control input for both signal structures, with the exception of devices featuring separate inputs. When used as a DALI ballast, control is effected via the DALI protocol; when used as a PUSH ballast, control is effected via a push key and is achieved via current flow times of differing duration.

Due to the working principle involved, dimming compact fluorescent lamps causes a negligible drop in colour temperature. However, sudden larger changes in the dimmer setting can temporarily cause greater variation in colour temperature. The dimmer function is optimised to minimise this subjective visual change in colour temperature when the dimmer setting is suddenly subjected to larger change.

VS DALI electronic ballasts are characterised by the following performance feature

- Two-strand, potential-free, polarity-independent control input
- Dimmer curve analogue to the light sensitivity of the human eye
- Addressing options: total system, group-wise or individually
- Scene memory
- Feedback in the event of defective lamps

These features ensure a number of advantages for lighting systems

- No group wiring needed
- Each DALI ballast can be individually addressed
- No need for scene memory modules
- Synchronised scene transitions
- Operating devices provide reports on lamp status
- Simple integration into facility management systems



VS DALI electronic ballasts provide the convenience of a bus system that is both easy to install and operate.

DALI and PUSH must not be used at the same time!

Switching mains voltage to the DALI conductors within a DALI system will lead to the destruction of both the DALI power supply and the DALI master!

1

2

3

4

5

6

7

8

9

10

PUSH function characteristic

- Just one key for dimming and ON/OFF
- Polarity- and phase-independent control
- Control input with large working voltage range
- Suitable for multi-layer control
- Fully DC-compatible – no functional restrictions during DC operation
- After disconnection from the primary voltage the ballast will reproduce the last stored lighting level
- Soft start
- Automatic recognition of DALI and PUSH signals

PUSH operating voltage ranges during control signal input

EB type	ELXd 117.715, ELXd 217.717, ELXd 118.705, ELXd 218.707, ELXd 142.709, ELXd 242.711	All other DALI/PUSH ballasts
AC	220-240 V ±10%	10-230 V
DC	198-264 V	–
Failing to observe these working voltage ranges can lead to non-recognition of the signals; exceeding the maximum voltages can lead to the destruction of the data inputs.		

PUSH control signals (key activation)

Short push	(80 ms < t < 460 ms)	(0 ms < t < 500 ms)
	Is used to switch between ON/OFF lighting states. After the device is switched on, the last selected lighting level is restored and the next dimming direction will be upwards.	
Long push	(460 ms < t < 10 s)	(500 ms < t < ∞)
	Is used to dim upwards or downwards; a long push will change the dimming direction. Thus, a long push will reverse the dimming direction until the upper or lower limit is reached. If the light was off, a long push will switch it on and the dimmer will start at the lowest light intensity.	
Push to synchronise	(t > 10 s)	long - short - long
	Light is dimmed to the preset factory level and the next dimming direction will be upwards.	Starting situation: luminaires are switched off. The "long - short - long" combination first switches the lamp on, then off and finally on again, after which it gets gradually brighter. The EBs will be synchronised again after this procedure.
Synchronisation	Any 1-key dimmer that does not feature a central control module (as each ballast will have its own controls) can develop asynchronous behaviour (e.g. children might play with the key). The system will then be out of sync, i.e. some lamps will be on, others off or the dimming direction will differ from lamp to lamp.	
	Two methods of synchronisation can be used:	
	<ul style="list-style-type: none"> • Push the key for more than 10 seconds, after which the light will be dimmed to a preset level and the next dimming direction will be upwards. • Start with a long push of the key so that all lamps are switched on. Follow with a short push to turn the system off. The system will now be resynchronised. 	

Wiring examples for PUSH function

Note **Not permissible:** N-type conductors must not be used as PUSH potentials for multi-phase systems. Example: if the PUSH key is not activated, the series connection of the internal resistors of the DA inputs will approach the delta voltage of 400 V (voltage between L2 and L3) (Fig. 1).

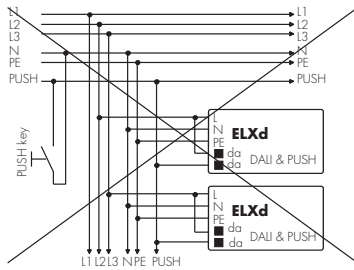

Fig. 1
N conductor must not be used as a PUSH potential

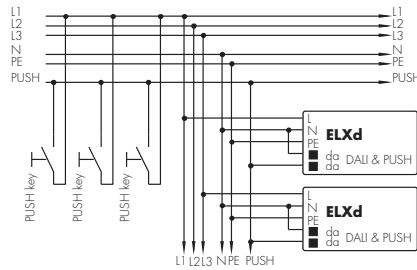

Fig. 2
Standard application for T5 and T8 lamps

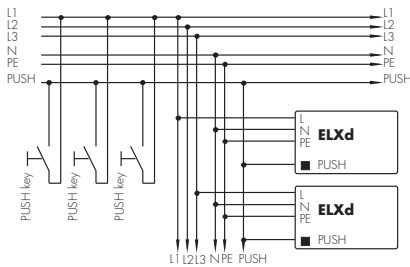

Fig. 3
Standard application for TC lamps

General information on PUSH and DALI

Mains voltage and interface conductors must not be wired in parallel to the lamp conductors so as to avoid capacitive bridging of the mains filter.

If more than one device is operated with a single key during PUSH operation, asynchronous behaviour can occur, which will require manual resynchronisation using the method described. Should this be unacceptable, a DALI control module will have to be used instead. It is recommended not to control more than four devices using a single key.

When using dimmable devices, new lamps should generally be burnt in for at least 100 hours at full brightness before they are dimmed. This process can become necessary again should the lamps be physically relocated (e.g. transport).

After initial operation of a DALI system (address assignment, luminaire allocation, group formation, scene settings) it is recommended to disconnect the primary voltage of the DALI control units at the circuit breaker for at least 3 seconds and then to reconnect it. The devices will detect this disconnection from the mains and store the settings.

DALI devices with a PUSH function must be operated with a control module (DALI control module or key pad with PUSH function). DALI devices with a PUSH function must not be operated with an open or bridged DALI/PUSH input.

To ensure the ballast does not distort and misinterpret signals when operated in PUSH mode, connected PUSH buttons must not feature a control lamp.

1

2

3

4

5

6

7

8

9

10

Circuit diagrams for Vossloh-Schwabe electronic ballasts

The circuit diagrams shown here are wiring examples for Vossloh-Schwabe electronic ballasts, whereby the number and configuration of the contacts differ. See the table on page 239-241 for details.

EB	1 lamp	2 lamps	3 lamps	4 lamps
ELXd		<p>Linear ballast shape*</p> <p>Compact ballast shape</p>		
ELXc				

* ELXc devices can also be wired under observation of the circuit diagram on the ballast.

Explanation of circuit diagrams for Vossloh-Schwabe electronic ballasts (see page 238)

Electronic ballasts		Lamp Quantity	Electronic ballasts Terminals															Max. lead length		Operation frequency kHz	Output voltage U _{OUT} V	THD %	Possible quantity of EB/automatic cut-outs			
Ref. No.	Type		1	2	3	4	5	6	7	8	9	10	11	12	13	14	15	hot* (m/pf)	cold (m/pf)				B (10A)	B (16A)	C (10A)	C (16A)
ELXc																										
183039	ELXc 424.223	3	x*	x*	-	x	x	x	x	-	-	x	x	-	-	-	-	1/100	2/200	44	400	< 10	9	14	14	22
		4	x*	x*	-	x	x	x	x	x	x	x	x	-	-	-	-	1/100	2/200	44	400	< 10	9	14	14	22
183040	ELXc 226.878	1	x	x	-	-	x*	x*	-	-	-	-	-	-	-	-	-	1/100	1.5/150	45	300	< 10	11	18	18	30
		2	x	x	x	x	x*	x*	-	-	-	-	-	-	-	-	-	1/100	1.5/150	45	300	< 10	11	18	18	30
183108	ELXc 226.878	1	x	x	-	-	x*	x*	-	-	-	-	-	-	-	-	-	1/100	1.5/150	45	300	< 10	11	18	18	30
		2	x	x	x	x	x*	x*	-	-	-	-	-	-	-	-	-	1/100	1.5/150	45	300	< 10	11	18	18	30
183109	ELXc 414.227	3	x*	x*	x	x	x	x	x	x	x	x*	x*	-	-	-	-	1/100	2/200	45	350	< 15	7	12	12	20
		4	x*	x*	x	x	x	x	x	x	x	x*	x*	-	-	-	-	1/100	2/200	45	350	< 15	7	12	12	20
183110	ELXc 424.228	3	x*	x*	x	x	x	x	x	x	x	x*	x*	-	-	-	-	1/100	2/200	47	350	< 15	7	12	12	20
		4	x*	x*	x	x	x	x	x	x	x	x*	x*	-	-	-	-	1/100	2/200	47	350	< 15	7	12	12	20
183111	ELXc 228.229	1	x*	x*	x	x	x	x	-	-	-	-	-	-	-	-	-	1/100	2/200	47	350	< 15	9	15	15	25
		2	x*	x*	x	x	x	x	-	-	-	-	-	-	-	-	-	1/100	2/200	47	350	< 20	9	15	15	25
183112	ELXc 328.230	2	x*	x*	x	x	x	x	x	x	x*	x*	-	-	-	-	-	1/100	2/200	45	350	< 15	7	12	12	20
		3	x*	x*	x	x	x	x	x	x	x*	x*	-	-	-	-	-	1/100	2/200	45	350	< 15	7	12	12	20
183113	ELXc 135.231	1	x*	x*	x	x	-	-	-	-	-	-	-	-	-	-	-	1/100	2/200	47	400	< 15	11	18	18	30
183114	ELXc 235.232	2	x	x	x*	x*	x*	x*	-	-	-	-	-	-	-	-	-	1/100	2/200	46	400	< 15	9	15	15	25
183115	ELXc 239.233	1	x*	x*	x	x	x	x	-	-	-	-	-	-	-	-	-	1/100	2/200	47	350	< 15	7	12	12	20
		2	x*	x*	x	x	x	x	-	-	-	-	-	-	-	-	-	1/100	2/200	47	350	< 15	7	12	12	20
183116	ELXc 149.234	1	x*	x*	x	x	-	-	-	-	-	-	-	-	-	-	-	1/100	2/200	47	250	< 15	9	15	15	25
183117	ELXc 249.235	2	x	x	x*	x*	x*	x*	-	-	-	-	-	-	-	-	-	1/100	2/200	47	350	< 15	7	12	12	20
183118	ELXc 254.236	1	x*	x*	x	x	x	x	-	-	-	-	-	-	-	-	-	1/100	2/200	48	350	< 15	7	12	12	20
		2	x*	x*	x	x	x	x	-	-	-	-	-	-	-	-	-	1/100	2/200	48	350	< 15	7	12	12	20
183119	ELXc 180.237	1	x*	x*	x	x	-	-	-	-	-	-	-	-	-	-	-	1/100	2/200	46	350	< 15	9	15	15	25
183122	ELXc 114.238	1	x*	x*	x	x	-	-	-	-	-	-	-	-	-	-	-	1/100	2/200	45	380	< 20	8	17	17	28
183123	ELXc 128.239	1	x*	x*	x	x	-	-	-	-	-	-	-	-	-	-	-	1/100	2/200	45	380	< 20	8	17	17	28
183124	ELXc 214.240	2	x	x	x	x	x*	x*	x*	-	-	-	-	-	-	-	-	1/100	2/200	45	380	< 20	8	17	17	28
183125	ELXc 228.241	2	x	x	x	x	x*	x*	x*	-	-	-	-	-	-	-	-	1/100	2/200	45	380	< 20	4	7	7	12
183126	ELXc 414.242	4	x*	x*	x	x	x	x	x	x	x*	x*	-	-	-	-	-	1/100	2/200	45	430	< 20	4	7	7	12
183127	ELXc 118.243	1	x*	x*	x	x	-	-	-	-	-	-	-	-	-	-	-	1/100	2/200	45	390	< 20	8	17	17	28
183128	ELXc 136.244	1	x*	x*	x	x	-	-	-	-	-	-	-	-	-	-	-	1/100	2/200	45	390	< 20	8	17	17	28
183129	ELXc 158.245	1	x*	x*	x	x	-	-	-	-	-	-	-	-	-	-	-	1/100	2/200	45	390	< 20	4	7	7	12
183130	ELXc 218.246	2	x*	x*	x	x	x	x	-	-	-	-	-	-	-	-	-	1/100	2/200	45	390	< 20	8	17	17	28
183131	ELXc 236.247	2	x*	x*	x	x	x	x	-	-	-	-	-	-	-	-	-	1/100	2/200	45	390	< 20	4	7	7	12
183132	ELXc 258.248	2	x*	x*	x	x	x*	x*	x	-	-	-	-	-	-	-	-	1/100	2/200	45	390	< 20	2	5	5	8
183133	ELXc 418.249	4	x*	x*	x	x	x	x	x	x	x*	x*	-	-	-	-	-	1/100	2/200	45	390	< 20	4	7	7	12
183134	ELXc 118.879	1	x*	x*	x	x	-	-	-	-	-	-	-	-	-	-	-	1/100	2/200	45	380	< 20	8	17	17	28
183135	ELXc 126.880	1	x*	x*	x	x	-	-	-	-	-	-	-	-	-	-	-	1/100	2/200	45	380	< 20	8	17	17	28
183136	ELXc 218.881	2	x*	x*	x	x	x*	x*	-	-	-	-	-	-	-	-	-	1/100	2/200	45	380	< 20	4	7	7	12
183137	ELXc 226.882	2	x*	x*	x	x	x*	x*	-	-	-	-	-	-	-	-	-	1/100	2/200	45	380	< 20	4	7	7	12
188093	ELXc 135.856	1	x*	x*	x	x	-	-	-	-	-	-	-	-	-	-	-	1/100	2/200	44	330	< 10	11	18	18	30
188094	ELXc 235.857	2	x*	x*	x	x	x	x*	x*	-	-	-	-	-	-	-	-	1/100	2/200	45	330	< 10	9	15	15	25
188095	ELXc 149.858	1	x*	x*	x	x	-	-	-	-	-	-	-	-	-	-	-	1/100	2/200	28	330	< 10	11	18	18	30
188140	ELXc 140.862	1	x*	x*	x	x	-	-	-	-	-	-	-	-	-	-	-	1/100	2/200	45	250	< 10	11	18	18	30
188142	ELXc 154.864	1	x*	x*	x	x	-	-	-	-	-	-	-	-	-	-	-	1/100	2/200	34	300	< 10	9	15	15	25
188144	ELXc 180.866	1	x*	x*	x	x	-	-	-	-	-	-	-	-	-	-	-	1/100	2/200	45	300	< 10	9	15	15	25
188438	ELXc 414.868	3	x*	x*	-	x	x	x	-	-	x	x	-	-	-	-	-	1/100	2/200	45	400	< 10	7	12	12	20
		4	x*	x*	-	x	x	x	x	x	x	x	x	-	-	-	-	1/100	2/200	45	400	< 10	7	12	12	20
188589	ELXc 128.869	1	x*	x*	x	x	-	-	-	-	-	-	-	-	-	-	-	1/100	1.5/150	54	450	< 10	11	18	18	30
188590	ELXc 128.869	1	x*	x*	x	x	-	-	-	-	-	-	-	-	-	-	-	1/100	1.5/150	54	450	< 10	11	18	18	30
188595	ELXc 336.214	3	x	x	x	x	x	x	x*	x*	-	-	-	-	-	-	-	1/100	2/200	70	370	< 10	6	11	11	18
188616	ELXc 240.863	2	x*	x*	x	-	x	x	-	-	-	-	-	-	-	-	-	1/100	2/200	46	360	< 15	7	12	12	20
188617	ELXc 249.859	2	x*	x*	x	x	x	x*	x*	-	-	-	-	-	-	-	-	1/100	2/200	43	480	< 10	7	12	12	20
188618	ELXc 254.865	2	x*	x*	x	-	x	x	x	-	-	-	-	-	-	-	-	1/100	2/200	43	390	< 10	7	12	12	20
188619	ELXc 280.538	2	x*	x*	x	x	x	x*	x*	-	-	-	-	-	-	-	-	1/100	2/200	50	420	< 10	-	10	-	10
188643	ELXc 242.837	2	x	x	x	x	x*	x*	-	-	-	-	-	-	-	-	-	1/100	1.5/150	43	440	< 15	7	12	12	20
188680	ELXc 155.378	1	x	x	x*	x*	-	-	-	-	-	-	-	-	-	-	-	1/100	1.5/150	47	250	< 15	7	12	12	20
188681	ELXc 155.378	1	x	x	x*	x*	-	-	-	-	-	-	-	-	-	-	-	1/100	1.5/150	47	250	< 15	7	12	12	20
188687	ELXc 242.837	2	x	x	x	x	x*	x*	-	-	-	-	-	-	-	-	-	1/100	1.5/150	43	440	< 15	7	12	12	20

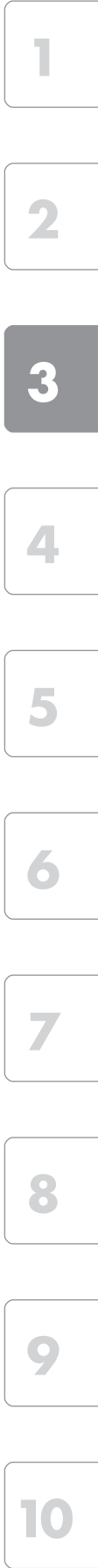

Technical Details - Components for Fluorescent Lamps

Electronic ballasts		Lamp	Electronic ballasts															Max. lead length		Operation	Output	THD	Possible quantity of							
Ref. No.	Type	Quantity	Terminals															hot*	cold	frequency	voltage U _{OUT}	%	EB/automatic cut-outs							
			1	2	3	4	5	6	7	8	9	10	11	12	13	14	15	(m/pt)	(m/pt)				kHz	V	B	B	C	C		
ELXc																														
188698	ELXc 213.870	1	x	x	-	-	x*	x*	-	-	-	-	-	-	-	-	-	-	-	-	1/100	1.5/150	42	250	< 20	11	18	18	30	
		2	x	x	x	x	x*	x*	-	-	-	-	-	-	-	-	-	-	-	-	1/100	1.5/150	42	250	< 20	11	18	18	30	
188699	ELXc 218.871	1	x	x	-	-	x*	x*	-	-	-	-	-	-	-	-	-	-	-	-	1/100	1.5/150	35	350	< 12	11	18	18	30	
		2	x	x	x	x	x*	x*	-	-	-	-	-	-	-	-	-	-	-	-	1/100	1.5/150	35	350	< 12	11	18	18	30	
188700	ELXc 142.872	1	x	x	-	-	x*	x*	-	-	-	-	-	-	-	-	-	-	-	-	1/100	1.5/150	44	480	< 15	11	18	18	30	
		2	x	x	x	x	x*	x*	-	-	-	-	-	-	-	-	-	-	-	-	1/100	1.5/150	44	480	< 15	11	18	18	30	
188704	ELXc 136.207	1	x	x	-	-	x*	x*	-	-	-	-	-	-	-	-	-	-	-	-	-	-	-	48	350	< 20	11	18	18	30
188705	ELXc 236.208	2	x	x	x	x	x*	x*	-	-	-	-	-	-	-	-	-	-	-	-	-	-	-	45	250	< 20	11	18	18	30
188706	ELXc 158.209	1	x	x	-	-	x*	x*	-	-	-	-	-	-	-	-	-	-	-	-	-	-	-	33	250	< 20	9	15	15	25
188707	ELXc 258.210	2	x	x	x	x	x*	x*	-	-	-	-	-	-	-	-	-	-	-	-	-	-	-	48	350	< 20	7	12	12	19
188712	ELXc 213.870	1	x	x	-	-	x*	x*	-	-	-	-	-	-	-	-	-	-	-	-	1/100	1.5/150	42	250	< 20	11	18	18	30	
		2	x	x	x	x	x*	x*	-	-	-	-	-	-	-	-	-	-	-	-	1/100	1.5/150	42	250	< 20	11	18	18	30	
188713	ELXc 218.871	1	x	x	-	-	x*	x*	-	-	-	-	-	-	-	-	-	-	-	-	1/100	1.5/150	35	350	< 12	11	18	18	30	
		2	x	x	x	x	x*	x*	-	-	-	-	-	-	-	-	-	-	-	-	1/100	1.5/150	35	350	< 12	11	18	18	30	
188714	ELXc 142.872	1	x	x	-	-	x*	x*	-	-	-	-	-	-	-	-	-	-	-	-	1/100	1.5/150	44	480	< 15	11	18	18	30	
		2	x	x	x	x	x*	x*	-	-	-	-	-	-	-	-	-	-	-	-	1/100	1.5/150	44	480	< 15	11	18	18	30	
188744	ELXc 418.204	3	x*	x*	-	x	x	x	x	-	-	x	x	-	-	-	-	-	-	-	1/100	2/200	44	480	< 10	7	12	12	20	
		4	x*	x*	-	x	x	x	x	x	x	x	x	-	-	-	-	-	-	-	1/100	2/200	44	480	< 10	7	12	12	20	
188886	ELXc 213.874	1	x	x	-	-	x*	x*	-	-	-	-	-	-	-	-	-	-	-	-	1/75	1.5/100	44	250	< 10	11	18	18	30	
		2	x	x	x	x	x*	x*	-	-	-	-	-	-	-	-	-	-	-	-	1/75	1.5/100	44	250	< 10	11	18	18	30	
188887	ELXc 218.875	1	x	x	-	-	x*	x*	-	-	-	-	-	-	-	-	-	-	-	-	1/75	1.5/100	37	350	< 10	11	18	18	30	
		2	x	x	x	x	x*	x*	-	-	-	-	-	-	-	-	-	-	-	-	1/75	1.5/100	37	350	< 10	11	18	18	30	
188888	ELXc 142.876	1	x	x	-	-	x*	x*	-	-	-	-	-	-	-	-	-	-	-	-	1/75	1.5/100	44	480	< 10	11	18	18	30	
		2	x	x	x	x	x*	x*	-	-	-	-	-	-	-	-	-	-	-	-	1/75	1.5/100	44	480	< 10	11	18	18	30	
188889	ELXc 242.877	1	x	x	-	-	x*	x*	-	-	-	-	-	-	-	-	-	-	-	-	1/75	1.5/100	45	480	< 10	7	12	12	20	
		2	x	x	x	x	x*	x*	-	-	-	-	-	-	-	-	-	-	-	-	1/75	1.5/100	45	480	< 10	7	12	12	20	
188912	ELXc 136.216	1	x	x	-	-	x*	x*	-	-	-	-	-	-	-	-	-	-	-	-	1/75	1.5/100	47,5	430	< 20	17	28	28	46	
188913	ELXc 236.217	2	x*	x*	x	x	x*	x*	-	-	-	-	-	-	-	-	-	-	-	-	1/75	1.5/100	45	430	< 10	17	28	28	46	
188914	ELXc 158.218	1	x	x	-	-	x*	x*	-	-	-	-	-	-	-	-	-	-	-	-	1/75	1.5/100	34	430	< 10	17	28	28	46	
188915	ELXc 258.219	2	x*	x*	x	x	x*	x*	-	-	-	-	-	-	-	-	-	-	-	-	1/75	1.5/100	52	430	< 10	17	28	28	46	
188921	ELXc 135.220	1	x*	x*	x	x	-	-	-	-	-	-	-	-	-	-	-	-	-	-	1/100	2/150	41	300	< 10	11	18	18	30	
188922	ELXc 235.221	2	x	x	x	x	x	x*	x*	-	-	-	-	-	-	-	-	-	-	-	1/100	2/150	41	300	< 10	11	18	18	30	
ELXd																														
183059	ELXd 235.735	2	x*	x*	x	x	x	x*	x*	-	-	-	-	-	-	-	-	-	-	-	1/100	2/200	42	300	< 5	10	17	18	28	
183329	ELXd 124.600	1	x	x	-	-	x*	x*	-	-	-	-	-	-	-	-	-	-	-	-	1/100	1.5/150	76-120	430	< 10	17	28	28	46	
183330	ELXd 224.601	2	x	x	x	x	x*	x*	x*	x*	-	-	-	-	-	-	-	-	-	-	1/100	1.5/150	53-120	430	< 10	17	28	28	46	
183331	ELXd 139.602	1	x	x	-	-	x*	x*	-	-	-	-	-	-	-	-	-	-	-	-	1/100	1.5/150	85-120	430	< 10	17	28	28	46	
183332	ELXd 154.603	1	x	x	-	-	x*	x*	-	-	-	-	-	-	-	-	-	-	-	-	1/100	1.5/150	83-120	430	< 10	17	28	28	46	
183333	ELXd 254.604	2	x	x	x	x	x*	x*	x*	x*	-	-	-	-	-	-	-	-	-	-	1/100	1.5/150	44-120	430	< 10	8	13	13	21	
183334	ELXd 180.605	1	x	x	-	-	x*	x*	-	-	-	-	-	-	-	-	-	-	-	-	1/100	1.5/150	91-120	430	< 10	12	19	19	31	
183335	ELXd 249.606	2	x	x	x	x	x*	x*	x*	x*	-	-	-	-	-	-	-	-	-	-	1/100	1.5/150	44-120	430	< 10	8	13	13	21	
183336	ELXd 124.607	1	x	x	-	-	x*	x*	-	-	-	-	-	-	-	-	-	-	-	-	1/100	1.5/150	76-120	430	< 10	17	28	28	46	
183337	ELXd 224.608	2	x	x	x	x	x*	x*	x*	x*	-	-	-	-	-	-	-	-	-	-	1/100	1.5/150	53-120	430	< 10	17	28	28	46	
183338	ELXd 139.609	1	x	x	-	-	x*	x*	-	-	-	-	-	-	-	-	-	-	-	-	1/100	1.5/150	85-120	430	< 10	17	28	28	46	
183339	ELXd 239.610	2	x	x	x	x	x*	x*	x*	x*	-	-	-	-	-	-	-	-	-	-	1/100	1.5/150	53-120	430	< 10	17	28	28	46	
183340	ELXd 154.611	1	x	x	-	-	x*	x*	-	-	-	-	-	-	-	-	-	-	-	-	1/100	1.5/150	83-120	430	< 10	17	28	28	46	
183341	ELXd 254.612	2	x	x	x	x	x*	x*	x*	x*	-	-	-	-	-	-	-	-	-	-	1/100	1.5/150	44-120	430	< 10	8	13	13	21	
183342	ELXd 180.613	1	x	x	-	-	x*	x*	-	-	-	-	-	-	-	-	-	-	-	-	1/100	1.5/150	91-120	430	< 10	12	19	19	31	
183343	ELXd 249.614	2	x	x	x	x	x*	x*	x*	x*	-	-	-	-	-	-	-	-	-	-	1/100	1.5/150	44-120	430	< 10	8	13	13	21	
183350	ELXd 239.621	2	x	x	x	x	x*	x*	x*	x*	-	-	-	-	-	-	-	-	-	-	1/100	1.5/150	53-120	430	< 10	17	28	28	46	
18431	ELXd 226.801	2	x	x	x	x	x*	x*	-	-	-	-	-	-	-	-	-	-	-	-	0.5/50	0.75/75	50-90	470	< 10	7	12	12	20	
18490	ELXd 226.801	2	x	x	x	x	x*	x*	-	-	-	-	-	-	-	-	-	-	-	-	0.5/50	0.75/75	50-90	470	< 10	7	12	12	20	
188549	ELXd 218.803	2	x*	x*	x	x	x	x*	x*	-	-	-	-	-	-	-	-	-	-	-	0.5/50	0.75/75	60-99	300	< 10	11	18	18	30	
188550	ELXd 242.807	2	x*	x*	x	x	x	x*	x*	-	-	-	-	-	-	-	-	-	-	-	0.5/50	0.75/75	45-95	400	< 10	7	12	12	20	
188564	ELXd 118.802	1	x	x	-	-	x*	x*	-	-	-	-	-	-	-	-	-	-	-	-	0.5/50	0.75/75	60-105	400	< 10	11	18	18	30	
188565	ELXd 142.806	1	x	x	-	-	x*	x*	-	-	-	-	-	-	-	-	-	-	-	-	0.5/50	0.75/75	40-95	400	< 10	11	18	18	30	
188597	ELXd																													

Electronic ballasts		Lamp Quantity	Electronic ballasts Terminals															Max. lead length		Operation frequency kHz	Output voltage U _{OUT} V	THD %	Possible quantity of EB/automatic cut-outs			
Ref. No.	Type		1	2	3	4	5	6	7	8	9	10	11	12	13	14	15	hot* (m/pf)	cold (m/pf)				B (10A)	B (16A)	C (10A)	C (16A)
ELXd																										
188605	ELXd 280.631	2	x	x	x	x*	x*	x*	x*	-	-	-	-	-	-	-	1/100	1.5/150	44-120	430	< 10	5	9	9	15	
188694	ELXd 118.802	1	x	x	-	-	x*	x*	-	-	-	-	-	-	-	-	0.5/50	0.75/75	60-105	400	< 10	11	18	18	30	
188695	ELXd 142.806	1	x	x	-	-	x*	x*	-	-	-	-	-	-	-	-	0.5/50	0.75/75	40-95	400	< 10	11	18	18	30	
188696	ELXd 218.803	2	x*	x*	x	x	x	x*	x*	-	-	-	-	-	-	-	0.5/50	0.75/75	60-99	300	< 10	11	18	18	30	
188697	ELXd 242.807	2	x*	x*	x	x	x	x*	x*	-	-	-	-	-	-	-	0.5/50	0.75/75	45-95	400	< 10	7	12	12	20	
188717	ELXd 135.823	1	x*	x*	x	x	-	-	-	-	-	-	-	-	-	-	1/75	1.5/100	45	420	< 10	30	50	30	50	
188864	ELXd 117.715	1	-	-	x*	x*	x*	x*	-	-	-	-	-	-	-	-	0.5/50	1.5/150	47-80	400	< 10	10	15	15	25	
188865	ELXd 117.715	1	-	-	x*	x*	x*	x*	-	-	-	-	-	-	-	-	0.5/50	1.5/150	47-80	400	< 10	10	15	15	25	
188866	ELXd 217.717	2	x*	x*	x*	x*	x*	x*	x*	-	-	-	-	-	-	-	0.5/50	1.5/150	34-94	250	< 10	11	18	18	30	
188867	ELXd 217.717	2	x*	x*	x*	x*	x*	x*	x*	-	-	-	-	-	-	-	0.5/50	0.5/50	34-94	250	< 10	11	18	18	30	
188873	ELXd 118.718	1	x*	x*	x	x	-	-	-	-	-	-	-	-	-	-	1.5/150	2.0/200	55-113	300	< 5	15	24	25	40	
188874	ELXd 218.719	2	x*	x*	x	x	x	x*	x*	-	-	-	-	-	-	-	1.5/150	2.0/200	42-114	400	< 5	17	27	28	46	
188875	ELXd 136.720	1	x*	x*	x	x	-	-	-	-	-	-	-	-	-	-	1.5/100	2.0/200	47-105	300	< 5	15	24	25	40	
188876	ELXd 236.721	2	x*	x*	x	x	x	x*	x*	-	-	-	-	-	-	-	1.5/100	2.0/200	42-107	400	< 5	17	27	27	44	
188877	ELXd 158.722	1	x*	x*	x	x	-	-	-	-	-	-	-	-	-	-	1.5/100	2.0/200	47-105	300	< 8	15	24	25	40	
188878	ELXd 258.723	2	x*	x*	x	x	x	x*	x*	-	-	-	-	-	-	-	1.5/150	2.0/200	45-110	400	< 10	11	18	19	31	
188923	ELXd 142.709	1	-	-	x*	x*	x*	x*	-	-	-	-	-	-	-	-	0.5/50	0.5/50	41-104	400	< 10	8	12	12	20	
188924	ELXd 142.709	1	-	-	x*	x*	x*	x*	-	-	-	-	-	-	-	-	0.5/50	0.5/50	41-104	400	< 10	8	12	12	20	
188932	ELXd 135.724	1	x*	x*	x	x	-	-	-	-	-	-	-	-	-	-	1/100	2/200	43	330	< 10	11	17	18	29	
188933	ELXd 235.725	2	x*	x*	x	x	x	x*	x*	-	-	-	-	-	-	-	1/100	2/200	43	330	< 5	10	17	18	28	
188952	ELXd 118.705	1	-	-	x*	x*	x*	x*	-	-	-	-	-	-	-	-	0.5/50	0.5/50	47	250	< 10	13	20	21	34	
188953	ELXd 118.705	1	-	-	x*	x*	x*	x*	-	-	-	-	-	-	-	-	0.5/50	0.5/50	47	250	< 10	13	20	21	34	
188954	ELXd 218.707	2	x*	x*	x*	x*	x*	x*	x*	-	-	-	-	-	-	-	0.5/50	0.5/50	41	250	< 10	12	20	21	33	
188955	ELXd 218.707	2	x*	x*	x*	x*	x*	x*	x*	-	-	-	-	-	-	-	0.5/50	0.5/50	41	250	< 10	12	20	21	33	
188974	ELXd 242.711	2	x*	x*	x*	x*	x*	x*	x*	-	-	-	-	-	-	-	0.5/50	0.5/50	40	250	< 10	12	20	21	33	
188975	ELXd 242.711	2	x*	x*	x	x*	x*	x*	-	-	-	-	-	-	-	-	0.5/50	0.5/50	40	250	< 10	12	20	21	33	

Electromagnetic ballasts

Electromagnetic (inductive) ballasts are active components that in conjunction with starters preheat the lamp electrodes, supply the ignition voltage and stabilise lamp currents during operation. Series or parallel capacitors are required to compensate blind current.

For installation in luminaires, consideration must be taken of the mains voltage and mains frequency, the dimensions and maximum thermal values as well as any potential noise generation. To fulfil these special requirements, Vossloh-Schwabe provides a large variety of different ballasts.

VS magnetic ballasts have been optimised with regard to their magnetic fields and loads so that usually so that noise cannot usually be perceived. However, the luminaire design can cause magnetic vibrations to affect large areas. When designing luminaires, it might therefore be necessary to fit a concertina section or grooves to prevent vibrations from spreading and thus from noise being generated.

The service life of an inductive ballast is mainly determined by the material chosen for the winding insulation. The maximum winding temperature denotes the temperature (tw) that the insulation will withstand for a period of 10 years given continuous operation under rated conditions. This maximum winding temperature must not be exceeded in real conditions to ensure the ballast can achieve its full service life. The winding temperature of the ballast that is measured in the luminaire is made up of the ambient temperature of the luminaire, the thermal conditions within the luminaire and the power loss of the ballast. The Δt marking on the ballast type plate provides a measure of the power loss of the ballast. In addition to this, the power loss of ballast-lamp circuits is measured in accordance with EN 50294. This test method forms the basis for the CELMA energy classification of ballasts and is also applied in European Regulation 245/2009/EG "Definition of eco-design requirements regarding fluorescent lamps without an integrated ballast, high-pressure discharge lamps as well as ballasts and luminaires in their operation and the invalidation of Directive 2000/55/EC" (see pages 251 - 253 for further details).

As a result of their design features, inductive ballasts cause leak current that is discharged via the earth conductor of the luminaire. The maximum permissible leak current for protection class I luminaires is 1 mA, a value of which all Vossloh-Schwabe electronic ballasts fall clearly short. Values of max. 0.1 mA are measured per electromagnetic ballast. However, as these values accumulate with the number of installed ballasts, this should be taken into account when dimensioning the F1 protective switch.

Starters for fluorescent lamps

As mentioned above, the operation of fluorescent lamps also requires starters in addition to ballasts. A distinction is made between glow starters, which are also available with automatic cut-outs, and electronic starters. The correct choice of voltage and power range is crucial. Starters are available for 220–240 V and for 110–127 V mains voltage. The latter are also required for twin-lamp operation (e.g. 2x18 W at 230 V).

Operating SL-series VS ballasts (100–127 V) depends on the use of a 220–240 V starter as these operating devices are high-reactance transformers that supply higher voltages to the lamp. Starters should only be used with starter contacts with a hardness value of at least HB 100.

Assembly Instructions for Electromagnetic Ballasts

For mounting and installing of electromagnetic ballasts for fluorescent lamps

Mandatory regulations

DIN VDE 0100	Erection of low voltage installations
EN 60598-1	Luminaires – part 1: general requirements and tests
EN 61347-1	Operating devices for lamps – part 1: general and safety requirements
EN 61347-2-8	Operating devices for lamps – part 2-8: special requirements for ballasts for fluorescent lamps
EN 60921	Ballasts for fluorescent tube lamps – performance requirements
EN 50294	Methods for measuring the total input power of ballast-lamp circuits
EN 55015	Maximum values and methods of measurement for RFI suppression in electrical lighting installations and similar electrical appliances
EN 61000-3-2	Electromagnetic Compatibility (EMC) – part 3: maximum values – main section part 2: maximum values for mains harmonics (device input current up to and including 16 A per conductor)
EN 61547	Installations for general lighting purposes – EMC immunity requirements

Technical specifications

Operating voltage range	VS ballasts can be operated at the specified mains voltage within a tolerance range of $\pm 10\%$
Leak current	≤ 0.1 mA per ballast

Technical Details – Components for Fluorescent Lamps

Error current	Impulse-resistant leak-current protection must be installed. Distribute the luminaires to phases L1, L2 and L3; install tri-phase FI switches. If permissible, install FI switches with 30 mA leak current; connect no more than 15 luminaires as FI switches can be triggered at half the leak current value.
Power factor	Inductive ballasts: $\lambda \leq 0.5$ Parallel-compensated ballasts: $\lambda \geq 0.85$
Compensation	VS recommends the use of parallel capacitors owing to their technical advantages and power balance.
Possible interference with IR systems	Are not known to occur

Mechanical mounting

Mounting position	Any
Mounting location	Ballasts are designed for installation in luminaires or comparable devices. Independent ballasts do not need to be installed in a casing.
Fastening	Preferably using screws \varnothing 4 mm
Maximum temperatures	The stipulated winding temperature (tw 130, tw 140 and tw 150, respectively) must not be exceeded during normal operation. The corresponding maximum values (232°C, 248°C and 264°C, respectively) must be observed during anomalous operation. These values must be checked by measuring resistance during operation.
Temperature increase	<p>The lamp current flowing through the ballast generates a power loss that leads to an increase in winding temperature. The Δt values for normal and abnormal operation provide a measure of this temperature increase. The Δt values are ascertained using standardised connections for measurement and are provided on the ballast type plate in Kelvin.</p> <p>Example: $\Delta t = 55 \text{ K} / 140 \text{ K}$: The first Δt value indicates the temperature increase for normal operation at the lamp's operating current. The second value, 140 K in this case, denotes the temperature increase of the winding that results from the current that flows when the lamp's discharge path is short-circuited. The current that flows in this state is the preheat current through the lamp's electrodes.</p>

Electromagnetic compatibility (EMC)

Interference	Interference voltage measurements have to be taken at the connection terminals for luminaires with magnetic ballasts as these are systems that operate with lamp voltages of under 100 Hz. These low-frequency interference voltages are generally not critical with magnetic ballasts.
Interference immunity	Thanks to the robust design and choice of materials, magnetic ballasts provide a high degree of interference immunity and are not impaired by admissible mains power interference.

1

2

3

4

5

6

7

8

9

10

Mains Harmonics After every zero crossing of the lamp current, fluorescent lamps experience a re-ignition peak as the lamps go out for a brief (imperceptible) moment. These re-ignition peaks generate mains harmonics that are smoothed by the ballast's impedance. The right design, i.e. determining the operating point of the magnetic ballast, ensures mains harmonics are limited to the maximum values permitted by EN 61000-3-2. VS electromagnetic ballasts all comply with the stipulated maximum values.

Selection of automatic cut-outs for VS electromagnetic ballasts

Dimensioning automatic cut-outs

When a ballast is switched on, high transient current peaks occur due to parasite capacitances that can accumulate with the number of luminaires. These high system switch-on currents put a strain on the automatic conductor cut-outs. For this reason, only surge-current-proof automatic cut-outs should be used for lighting systems.

Release reaction The release reaction of the automatic conductor cut-outs comply with VDE 0641, part 11, for B and C characteristics.

No. of ballasts The following values are meant as guidelines only and may vary depending on the respective lighting system. The maximum number of VS ballasts applies to cases where the devices are switched on simultaneously. Specifications apply to single-pole fuses. The number of permissible ballasts must be reduced by 20% for multi-pole fuses. The considered circuit impedance equals 400 mΩ (approx. 20 m of [2.5 m²] conductor from the power supply to the distributor and a further 15 m to the luminaire). Doubling circuit impedance to 800 mΩ increases the possible number of ballasts by 10%. The values quoted in the following tables are guidelines and can be affected by system-specific factors.

Possible number of ballasts connected to automatic cut-outs for compact fluorescent lamps (single lamp operation)

Lamp output W	10 A (B)		16 A (B)	
	Inductive	Parallel compensation	Inductive	Parallel compensation
5/7/8/9/10/11/13	50	90	80	130
18 (TC-L)	27	32	43	51
18 (TC-D)	40	65	65	110
24	25	32	40	51
26	27	32	43	51
36	23	32	37	51

Possible number of ballasts connected to automatic cut-outs for tubular and U-shaped fluorescent lamps (single lamp operation)

Lamp output W	10 A (B)		16 A (B)	
	Inductive	Parallel compensation	Inductive	Parallel compensation
4/6/8/10	50	90	80	130
13	45	80	70	115
15/18/20	27	32	43	51
30/36/38/40	23	32	37	51
58/65	15	20	22	32
70	13	18	20	30

Reliability and service life

Provided the specified maximum values for the winding temperature are complied with, a service life of 10 years can be expected. Failure rate: $\leq 0.025\%/1,000$ hours.

Electrical installation

Connection terminals (combination terminals)

- Use copper (not stranded) wire
- Required diameter for push-in connection 0.5 - 1 mm²
- Stripped lead length 8 mm
- Required cross-section for IDC zone 0.5 mm²; max. \varnothing 2 mm including insulation, no wire stripping required; mounting requires a special tool

Push-in terminals The integrated terminals can only be used with rigid leads.
Rigid leads: 0.5 - 1.5 mm². The stripped lead length totals 8 mm.

Wiring The wiring between the mains, ballasts and lamps must comply with the respective circuit diagram.

Circuit diagrams for the operation of fluorescent lamps with Vossloh-Schwabe electromagnetic ballasts

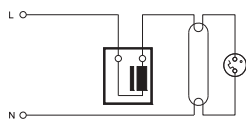

Inductive single circuit

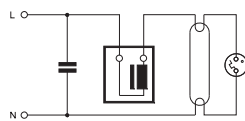

Parallel-compensated single circuit

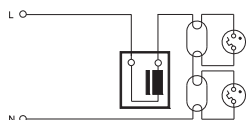

Inductive tandem circuit

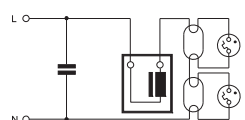

Parallel-compensated tandem circuit

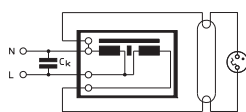

Parallel-compensated single circuit with high-reactance transformer

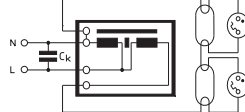

Parallel-compensated tandem circuit with high-reactance transformer

1

2

3

4

5

6

7

8

9

10

Connection terminals

In the interest of ensuring firm contacts and long component service life, Vossloh-Schwabe uses only top-quality materials for plastic or metal parts during the production of connection terminals. These quality features apply to both Vossloh-Schwabe's luminaire connection terminals as well as to the terminals fitted to ballasts and lampholders.

Notes on connection terminals on electronic ballasts

Vossloh-Schwabe electronic ballasts are fitted with installation-friendly push-in connectors. In addition, many models for linear fluorescent lamps are also available with IDC terminals (for solid conductors 0.5 mm²) and supplementary push-in terminals (for solid conductors 0.5–1 mm²), stripped length 8–9 mm. IDC terminals permit automated luminaire wiring and testing using the ALF system and are thus particularly efficient.

Notes on connection terminals on electromagnetic ballasts

Standard issue Vossloh-Schwabe electromagnetic ballasts are fitted with installation-friendly IDC/push-in terminals (combination terminals) or push-in terminals. The terminals are designed for use with solid conductors with cross-sections of 0.5–1 mm² (combination terminals) or up to 1.5 mm² (push-in terminals) and are approved for current loads of up to 6 A (combination terminal) and 16 A (push-in terminal). The lead stripping length totals 7–9 mm for push-in terminals; leads do not need to be stripped for IDC terminals.

On request, many ballasts can also be provided with screw terminals (current load up to 16 A) for conductor cross-sections of 0.5 to 2.5 mm².

Notes on connection terminals on lampholders

Vossloh-Schwabe usually equips lampholders for T and TC lamps as well as starter lampholders with installation-friendly push-in terminals for solid conductors of 0.5–1 mm². Most lampholders are fitted with twin push-in terminals and thus permit through-wiring. The required lead stripping length amounts to 8–9 mm for all types.

IDC terminals

In order to fully exploit the vast potential for rationalisation offered by automated wiring and testing with the ALF system, a totally new component family was developed that is equipped with the VDE-tested IDC terminal technology. This technology has already been used very successfully on a large scale in other branches of industry. This connection technology dispenses with the stripping of conductors that is required for the push-in, screw or crimping methods. The tried-and-tested IDC terminal technology has created the foundation for efficient automation as it ensures both high connection quality and rapid contacting. Components equipped in this fashion make it possible to through-wire several terminals with a single conductor. This constitutes a further economic advantage as it significantly reduces the required conductor lengths. Furthermore, this design principle makes it possible to use adapters to simply and reliably make electrical contact from above for a VDE-compatible final luminaire inspection.

ALF connection

Height: 12 mm

Release by twisting and pulling the conductor at the same time

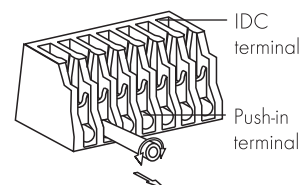

1. Insert release tool above the conductor
2. Pull out the conductor

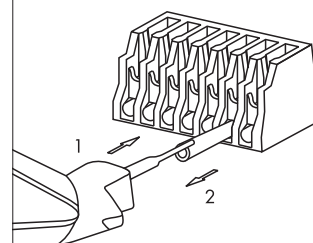

Stripping the conductor for push-in terminal 0.5–1 mm²: 8–9 mm

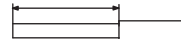

IDC/ Push-in terminal for electromagnetic ballasts

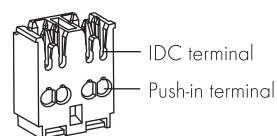

Stripping the conductor for push-in terminal 0.5–1 mm²: 7–9 mm

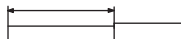

Lampholders for Fluorescent Lamps

Lampholders for compact fluorescent lamps

Vossloh-Schwabe produces the majority of lampholders for TC lamps using PBT, a thermoplastic material. This highly heat-resistant material is responsible for the T140 temperature rating. Leading lamp manufacturers also use PBT for the lamp bases they produce. This material harmonisation in conjunction with fatigue-free, stainless steel lamp mounting springs ensures a permanently secure lamp fit.

Lampholders for double-ended fluorescent lamps

VS lampholders for T lamps are characterised by a number of technical features that guarantee a high degree of reliability and safety. The heat-resistant PBT rotor with which most VS lampholders are fitted is a recognised trademark. In addition to the lampholders with the field-tested large rotor, VS also provides a new generation of lampholders featuring innovative "Rotoclic" rotor technology. This new VS technology constitutes a further milestone in the development of highly heat-resistant rotor systems.

Among the special features of this new technology is a T140 temperature rating thanks to a front plate made entirely of PBT as well as a clearly audible click when the lamp is inserted or replaced. As a result, the motion of turning the lamp from "replacement" to "operating" position is aided acoustically.

In addition to this, VS produces a further series of lampholders with a rotor-like function, whose front plates are also made of highly heat-resistant PBT and have similarly been given a T140 temperature rating.

The maximum permissible temperature at the back of all lampholders is T_m 110 °C. Another key feature common to all VS lampholders is a highly effective support for the lamp pin that reliably prevents any base pin deflection, even with older lamps, and guarantees a durable and firm contact.

Push-through lampholders

Push-through lampholders are inserted from below through a cut-out in the luminaire casing and are secured by lateral catches. This type of lampholder is frequently used in luminaires on which the lampholder remains visible from the outside, e.g. in so-called strip lighting. The electrical leads are laid beneath the sheet metal level. Luminaire directive EN 60598-1 Para. 8.2 must be observed with regard to the luminaire.

Push-fit lampholders

This lampholder type, which is frequently found in surface-mounted ceiling and built-in luminaires, is pushed into the luminaire casing from above. The lampholder foot should protrude by no more than 4 mm to match the usual height of the spacing cams in the luminaire casing. These lampholders are mostly wired above the luminaire casing to the side of the lampholder. However, there are also lampholders on which the wiring runs through the lampholder foot, with the leads laid beneath the luminaire casing.

Built-in lampholders

This design is also predominantly used for recessed ceiling and surface-mounted luminaires. However, unlike push-fit lampholders, built-in lampholders are usually fitted at the ends of the luminaire boxes. In addition to the usual fixing with split pins attached to the rear, there are also countless versions with fixing clips, push-fit studs or screw-in holes, which are also available with spring-loaded length compensation. Built-in lampholders offer luminaire designers a wealth of scope regarding the choice of lamp position in relation to the reflector. This enables great variation in light distribution as the lampholder does not dictate the distance of the centre of the lamp from the metal casing.







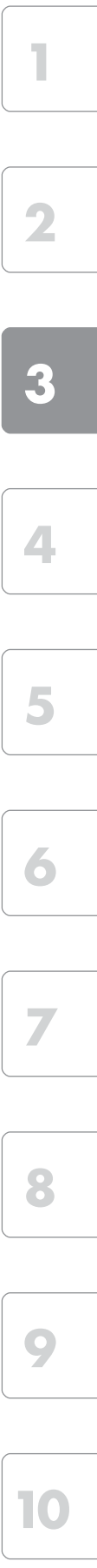
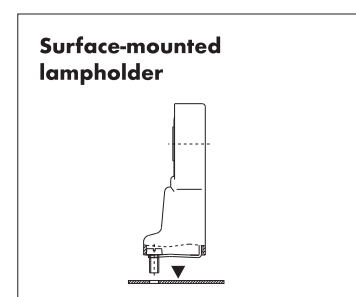
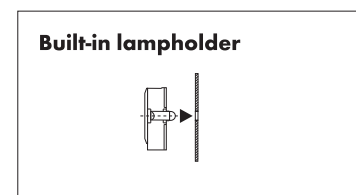
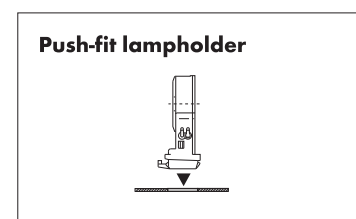
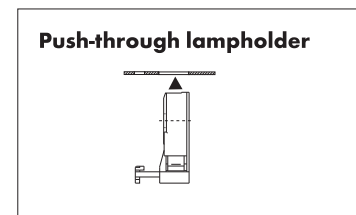
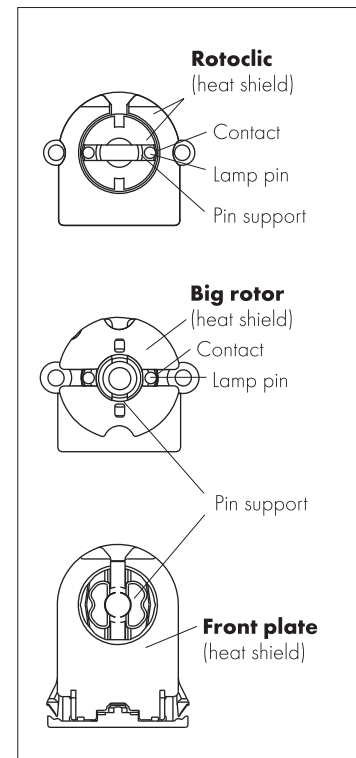



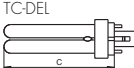



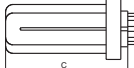





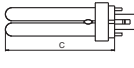



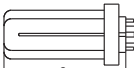



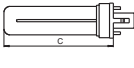

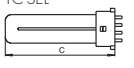

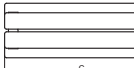

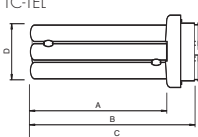

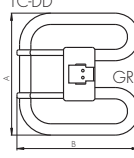
Surface-mounted lampholders

The fastening system of surface-mounted lampholders usually consists of screws or rivets above a fixing level, along which the wiring is also laid. As this type of installation is usually too costly nowadays for large unit numbers, these lampholders are used almost exclusively for special applications, e.g. displays or illuminated advertisements.

VS lampholders for the UL market and UL approved leads are available for all common lamp types. Further information can be found at www.unvlt.com.

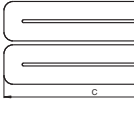

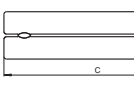
Lamp Table – Fluorescent Lamps

Lamp type/lamp base	Base	Output (W)	Max. length (C) acc. to IEC					
TC-DEL  G24q-1  -2  -3 	G24q-1	10 13	95 130					
	G24q-2	18	140					
	G24q-3	26	160					
TC-TEL  GX24q-1  -2  -3  -4  -5  -6 	GX24q-1	13	90					
	GX24q-2	18	110					
	GX24q-3	26	130					
		32	145					
	GX24q-4	42	155					
	GX24q-5	57	191					
TC-D  G24d-1  -2  -3 	G24d-1	8 10 13	73* 95 130					
		G24d-2	18	140				
		G24d-3	26	160				
TC-T  GX24d-1  -2  -3 	GX24d-1	13	90					
		GX24d-2	18	110				
			26	130				
TC-S  G23 	G23	5 7 9 11	85 115 145 215					
		TC-SEL  2G7 	5 7 9 11	85 115 145 215				
			TC-TEL  2G8-1 	60 85 120	167 208 285			
				TC-TEL  GR14q-1 	GR14q-1	14 17	A 99.7 121.7	B 120 142
TC-DD  GR8  GR10q  GRY10q-3  GRZ10d  GRZ10i 	GR8					16 28	A 138 205	B 141 207
		GR10q	10 16 21 28 38	92 138 138 205 205	95 141 141 207 207			
	GRY10q-3		55	205	205*			
	GRZ10d		18	137	141*			
	GRZ10i		30	202	206*			
	TC-F  2G10 	2G10	18 24 36	122 165 217				
TC-L  2G11 			2G11	18 24 34 36 40 55 80	225 320 533* 415 535 535 565			

*not included in IEC standard (non-committal specifications)

Lamp Table – Fluorescent Lamps

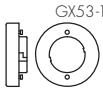
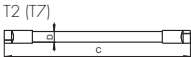
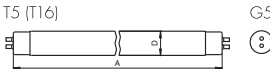
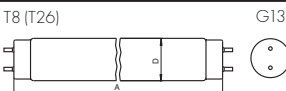
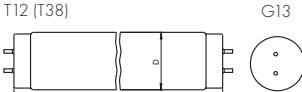
Lamp type/lamp base	Base	Output (W)	Ø D (mm)	Length A/C (mm) acc. to IEC 60081/ 60901 (for circular lamps B)
 GX53-1	GX53-1	7 9		
 T2 (T7) W4.3	W4.3x8.5d	6 8 11 13	7 7 7 7	219.3 320.9 422.5 524.1
 T5 (T16) G5	G5	4 6 8 13 14 20 21 24 25 28 32 34 35 39 45 49 50 54 73 80	16 16	135.9 212.1 288.3 516.9 549.0 549.0 849.0 549.0 1149.0 1149.0 1449.0 849.0 1449.0 849.0 1449.0 1449.0 1449.0 1149.0 1449.0 1449.0
 T8 (T26) G13	G13	10 14 15 16 16 18 20* ¹ 23 30 32 33 34 36 36 38 50 51 58 70	26 26 26 26 26 26 26 26 26 26 26 26 26 26 26 26 26 26 26 26	470.0* ² 360.0* ² 437.4 589.8 720.0* ² 589.8 438.0* ² 970.0* ² 894.6 1199.4 1149.0 1047.0* ² 1199.4 970.0* ² 1047.0 1500.0 1500.0 1500.0 1763.8
 T12 (T38) G13	G13	20 25 30 40 65 75 80* ¹ 85 85* ¹ 100 100* ¹ 115 125 140 140* ¹ 160* ¹	38 38 38 38 38 38 38 38 38 38 38 38 38 38 38 38 38 38	589.8 970.0 894.6 1199.4 1500.0 1763.8 1500.0 2374.3 1763.8 2374.3 1800.0* ² 1200.0* ² 2374.3 1500.0* ² 1800.0* ² 1800.0* ²

*¹ UV solarium lamps
*² Not included in IEC standard
(non-committal specifications)

- 1
- 2
- 3
- 4
- 5
- 6
- 7
- 8
- 9
- 10

Lamp Table – Fluorescent Lamps

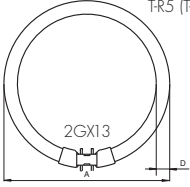
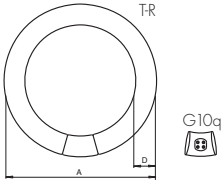
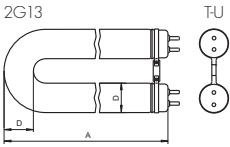
Lamp type/lamp base	Base	Output (W)	Ø D (mm)	A (mm)
	2GX13	22 40 55 60	16 16 16 16	230.0 305.0 305.0 379.0
	G10q	22 32 40 60	29 29 29 30	215.9 304.8 406.4 408.8*
	2G13-92	18 36 58	26 26 26	304* 566, 601* 566, 759*

* Not yet included in IEC standard
(non-committal specifications)

Tube lengths of plastic and glass protective tube

Ø D (mm)	Length L (mm)
38±0.5	L = A - 20±1
50±0.8	L = A - 30±1

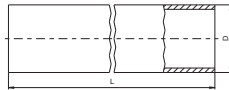

Key to lamp designations

TC-S	Tube Compact-Single
TC-SEL	Tube Compact-Single Electronic
TC-D	Tube Compact-Double
TC-DEL	Tube Compact-Double Electronic
TC-T	Tube Compact-Triple
TC-TEL	Tube Compact-Triple Electronic
TC-Q	Tube Compact-Quad
TC-QEL	Tube Compact-Quad Electronic
TC-DD	Tube Compact-Double D-Shape
TC-L	Tube Compact-Long
TC-F	Tube Compact-Flat
T2 (T7)	Tube Ø 2/8" (7 mm)
T5 (T16)	Tube Ø 5/8" (16 mm)
T8 (T26)	Tube Ø 8/8" (26 mm)
T12 (T38)	Tube Ø 12/8" (38 mm)
T-U	Tube, U-Shape
T-R	Tube, Ring-Shape
T-R5 (T-R16)	Tube, Ring-Shape Ø 5/8" (16 mm)

Energy efficiency classification

Together with the amendments in Commission Regulation (EU) 2015/1428 dated 25. August 2015, Commission Regulation (EU) 245/2009 dated 18. March 2009 implementing Directive 2005/32/EC of the European Parliament and of the Council with regard to defining ecodesign requirements for fluorescent lamps without integrated ballast, high-pressure discharge lamps and for ballasts and luminaires needed for their operation, and repealing Directive 2000/55/EC of the European Parliament and of the Council (official title), has created a legal framework in the EU that defines fundamental requirements for operating efficient lighting technology products.

Although the Regulation predominantly applies to general lighting, it is also product-orientated and thus independent of any specific application. The efficiency and performance requirements (specifications governing performance features) apply to fluorescent lamps without integrated ballast, high-pressure discharge lamps as well as ballasts and luminaires needed to operate these lamps.

1

2

3

4

5

6

7

8

9

10

Technical Details – Components for Fluorescent Lamps

Energy efficiency classification

The following table taken from Regulation 245/2009/EC provides an overview of (1st- and 2nd-stage) ballast requirements, ordered according to efficiency values:

Lamp data					Ballast efficiency (P_{lamp}/P_{input}) (non-dimmable ballasts)				
Type	Nominal output W	ILCOS-Code	Typical rating		A2 BAT %	A2 %	A3 %	B1 %	B2 %
			50 Hz W	HF W					
T8	15	FD-15-E-G13-26/450	15	13.5	87.8	84.4	75.0	67.9	62.0
	18	FD-18-E-G13-26/600	18	16	87.7	84.2	76.2	71.3	65.8
	30	FD-30-E-G13-26/900	30	24	82.1	77.4	72.7	79.2	75.0
	36	FD-36-E-G13-26/1200	36	32	91.4	88.9	84.2	83.4	79.5
	38	FD-38-E-G13-26/1050	38.5	32	87.7	84.2	80.0	84.1	80.4
	58	FD-58-E-G13-26/1500	58	50	93.0	90.9	84.7	86.1	82.2
	70	FD-70-E-G13-26/1800	69.5	60	90.9	88.2	83.3	86.3	83.1
TC-L	18	FSD-18-E-2G11	18	16	87.7	84.2	76.2	71.3	65.8
	24	FSD-24-E-2G11	24	22	90.7	88.0	81.5	76.0	71.3
	36	FSD-36-E-2G11	36	32	91.4	88.9	84.2	83.4	79.5
TC-F	18	FSS-18-E-2G10	18	16	87.7	84.2	76.2	71.3	65.8
	24	FSS-24-E-2G10	24	22	90.7	88.0	81.5	76.0	71.3
	36	FSS-36-E-2G10	36	32	91.4	88.9	84.2	83.4	79.5
TC-D/ TC-DE	10	FSQ-10-E-G24q=1 FSQ-10-I-G24d=1	10	9.5	89.4	86.4	73.1	67.9	59.4
	13	FSQ-13-E-G24q=1 FSQ-13-I-G24d=1	13	12.5	91.7	89.3	78.1	72.6	65.0
	18	FSQ-18-E-G24q=2 FSQ-18-I-G24d=2	18	16.5	89.8	86.8	78.6	71.3	65.8
	26	FSQ-26-E-G24q=3 FSQ-26-I-G24d=3	26	24	91.4	88.9	82.8	77.2	72.6
TC-T/ TC-TE	13	FSM-13-E-GX24q=1 FSM-13-I-GX24d=1	13	12.5	91.7	89.3	78.1	72.6	65.0
	18	FSM-18-E-GX24q=2 FSM-18-I-GX24d=2	18	16.5	89.8	86.8	78.6	71.3	65.8
	26	FSM-26-E-GX24q=3 FSM-26-I-GX24d=3	26.5	24	91.4	88.9	82.8	77.5	73.0
TC-DD/ TC-DDE	10	FSS-10-E-GR10q FSS-10-L/P/H-GR10q	10.5	9.5	86.4	82.6	70.4	68.8	60.5
	16	FSS-16-E-GR10q FSS-16-I-GR10q FSS-10-L/P/H-GR10q	16	15	87.0	83.3	75.0	72.4	66.1
	21	FSS-21-E-GR10q FSS-21-I-GR10q FSS-21-L/P/H-GR10q	21	19	89.4	86.4	79.2	73.9	68.8
	28	FSS-28-E-GR10q FSS-28-I-GR10q FSS-28-L/P/L-GR10q	28	26	89.7	86.7	81.3	78.2	73.9
	38	FSS-38-E-GR10q FSS-38-L/P/L-GR10q	38.5	36	92.3	90.0	85.7	84.1	80.4
TC	5	FSD-5-I-G23 FSD-5-E-2G7	5.4	5	72.7	66.7	58.8	49.3	41.4
	7	FSD-7-I-G23 FSD-7-E-2G7	7.1	6.5	77.6	72.2	65.0	55.7	47.8
	9	FSD-9-I-G23 FSD-9-E-2G7	8.7	8	78.0	72.7	66.7	60.3	52.6
	11	FSD-11-I-G23 FSD-11-E-2G7	11.8	11	83.0	78.6	73.3	66.7	59.6
T5	4	FD-4-E-G5-16/150	4.5	3.6	64.9	58.1	50.0	45.0	37.2
	6	FD-6-E-G5-16/225	6	5.4	71.3	65.1	58.1	51.8	43.8
	8	FD-8-E-G5-16/300	7.1	7.5	69.9	63.6	58.6	48.9	42.7
	13	FD-13-E-G5-16/525	13	12.8	84.2	80.0	75.3	72.6	65.0
T9-C	22	FSC-22-E-G10q-29/200	22	19	89.4	86.4	79.2	74.6	69.7
	32	FSC-32-E-G10q-29/300	32	30	88.9	85.7	81.1	80.0	76.0
	40	FSC-40-E-G10q-29/400	40	32	89.5	86.5	82.1	82.6	79.2

Lamp types



T8



TC-L



TC-F



TC-D/TC-DE

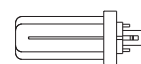

TC-T/TC-TE



TC-DD/TC-DDE

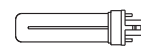

TC



T5

Technical Details – Components for Fluorescent Lamps

Lamp data					Ballast efficiency (P_{Lamp}/P_{Input})				
Type	Nominal output W	ILCOS-Code	Typical rating		(non-dimmable ballasts)				
			50 Hz W	HF W	A2 BAT %	A3 %	B1 %	B2 %	
T2	6	FDH-6-L/P-W4.3x8.5d-7/220		5	72.7	66.7	58.8	-	-
	8	FDH-8-L/P-W4.3x8.5d-7/320		7.8	76.5	70.9	65.0	-	-
	11	FDH-11-L/P-W4.3x8.5d-7/420		10.8	81.8	77.1	72.0	-	-
	13	FDH-13-L/P-W4.3x8.5d-7/520		13.3	84.7	80.6	76.0	-	-
	21	FDH-21-L/P-W4.3x8.5d-7		21	88.9	85.7	79.2	-	-
	23	FDH-23-L/P-W4.3x8.5d-7		23	89.8	86.8	80.7	-	-
T5-E	14	FDH-14-L/P-G5-16/550		13.7	84.7	80.6	72.1	-	-
	21	FDH-21-L/P-G5-16/850		20.7	89.3	86.3	79.6	-	-
	24	FDH-24-L/P-G5-16/550		22.5	89.6	86.5	80.4	-	-
	28	FDH-28-L/P-G5-16/1150		27.8	89.8	86.9	81.8	-	-
	35	FDH-35-L/P-G5-16/1450		34.7	91.5	89.0	82.6	-	-
	39	FDH-39-L/P-G5-16/850		38	91.0	88.4	82.6	-	-
	49	FDH-49-L/P-G5-16/1450		49.3	91.6	89.2	84.6	-	-
	54	FDH-54-L/P-G5-16/1150		53.8	92.0	89.7	85.4	-	-
	80	FDH-80-L/P-G5-16/1150		80	93.0	90.9	87.0	-	-
	95	FDH-95-L/P-G5-16/1150		95	92.7	90.5	84.1	-	-
	120	FDH-120-L/P-G5-16/1450		120	92.5	90.2	84.5	-	-
T5-C	22	FSCH-22-L/P-2GX13-16/225		22.3	88.1	84.8	78.8	-	-
	40	FSCH-40-L/P-2GX13-16/300		39.9	91.4	88.9	83.3	-	-
	55	FSCH-55-L/P-2GX13-16/300		55	92.4	90.2	84.6	-	-
	60	FSCH-60-L/P-2GX13-16/375		60	93.0	90.9	85.7	-	-
TC-IE	40	FSDH-40-L/P-2G11		40	91.4	88.9	83.3	-	-
	55	FSDH-55-L/P-2G11		55	92.4	90.2	84.6	-	-
	80	FSDH-80-L/P-2G11		80	93.0	90.9	87.0	-	-
TC-TE	32	FSMH-32-L/P-GX24q=3		32	91.4	88.9	82.1	-	-
	42	FSMH-42-L/P-GX24q=4		43	93.5	91.5	86.0	-	-
	57	FSM6H-57-L/P-GX24q=5 FSM8H-57-L/P-GX24q=5		56	91.4	88.9	83.6	-	-
	70	FSM6H-70-L/P-GX24q=6 FSM8H-70-L/P-GX24q=6		70	93.0	90.9	85.4	-	-
	60	FSM6H-60-L/P-2G8=1		63	92.3	90.0	84.0	-	-
	62	FSM8H-62-L/P-2G8=2		62	92.2	89.9	83.8	-	-
	82	FSM8H-82-L/P-2G8=2		82	92.4	90.1	83.7	-	-
	85	FSM6H-85-L/P-2G8=1		87	92.8	90.6	84.5	-	-
TC-DD	120	FSM6H-120-L/P-2G8=1 FSM8H-120-L/P-2G8=1		122	92.6	90.4	84.7	-	-
	55	FSSH-55-L/P-GR10q		55	92.4	90.2	84.6	-	-

At the very latest, the following energy efficiency formula for ballasts will be introduced to coincide with the 3rd stage:

$$\begin{aligned} \text{If } P_{Lamp} \leq 5 \text{ W} & \quad E_{Bb_{FL}} = 0.71 \\ \text{If } 5 \text{ W} < P_{Lamp} < 100 \text{ W} & \quad E_{Bb_{FL}} = P_{Lamp} / (2 * \sqrt{P_{Lamp}/36} + 38/36 * P_{Lamp} + 1) \\ \text{If } P_{Lamp} \geq 100 \text{ W} & \quad E_{Bb_{FL}} = 0.91 \end{aligned}$$

The following limiting values must be observed:

$\eta_{Ballast}$	Energy efficiency classes
$\geq E_{Bb_{FL}}$	A2 and A1 BAT
$\geq 1 - 0.75 * (1 - E_{Bb_{FL}})$	A2 BAT

The graph illustrates the difference between Classes A2, A1 BAT and A2 BAT (BAT = best available technology).

Lamp types

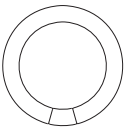

T9-C



T2



T5-E

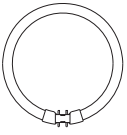

T5-C

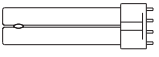

TC-IE

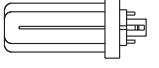

TC-TE



TC-DD

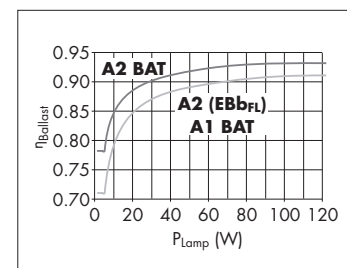

SYSTEM- OPTIMISING COMPENSATION



PARALLEL CAPACITORS

Capacitors are designed to compensate inductive reactive current of discharge lamps in 50/60 Hz networks when operated with electromagnetic ballasts. As required by utility companies, capacitors serve to compensate the reactive current generated by the respective ballast. A power factor of $\lambda \geq 0.9$ is achieved.

In addition, capacitors can also be used to compensate or generate phase displacements. Careful selection of the raw materials as well as special thermal treatment of the capacitor coil guarantee a long service-life and stable capacitance.



Parallel capacitors**254–259****Technical details for parallel capacitors****260–268**

General technical details

366–374

Glossary

375–377

1

2

3

4

5

6

7

8

9

10

Parallel Connected Capacitors with Break-action Mechanism

Capacitors type B

Casing: aluminium

Filling material: based on vegetable oil

Fastening: male nipple with nut and washer included

Discharge resistance

Overpressure protection

On request further capacities or connectors



A Push-in twin terminals 0.5–1 mm²

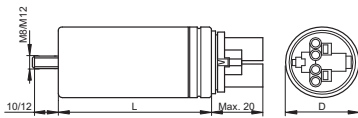

B Double spade connector 6.3x0.8 acc. to IEC 61210

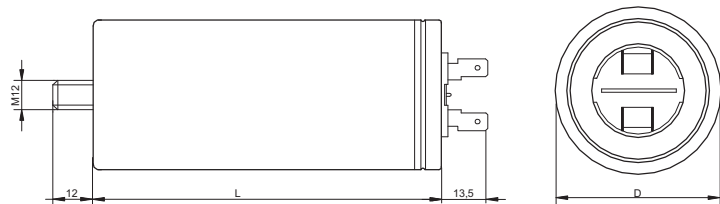

Parallel Connected Capacitors with Break-action Mechanism

Capacitors type B

Ref. No.	Capacity μF	Temperature range °C	Drawing	Ø (D) mm	Length (L) mm	Male nipple/ length (mm)	Weight g	Unit pcs.
250 V, 50/60 Hz								
536378	2.0	-40 to 100	A	25	63	M8x10	85	100
536379	4.0	-40 to 100	A	25	63	M8x10	85	100
536380	6.0	-40 to 100	A	25	63	M8x10	85	100
536381	8.0	-40 to 100	A	25	78	M8x10	90	100
551645	9.0	-40 to 100	A	30	78	M8x10	95	100
536382	10.0	-40 to 100	A	30	78	M8x10	95	100
536383	12.0	-40 to 100	A	30	78	M8x10	95	100
536384	13.0	-40 to 100	A	30	78	M8x10	95	100
536385	16.0	-40 to 100	A	35	78	M8x10	100	81
536386	18.0	-40 to 100	A	35	78	M8x10	100	81
536387	20.0	-40 to 100	A	35	78	M8x10	100	81
536388	25.0	-40 to 100	A	40	78	M8x10	110	64
536389	30.0	-40 to 100	A	35	103	M8x10	115	81
536390	32.0	-40 to 100	A	35	103	M8x10	115	81
536391	35.0	-40 to 100	A	40	103	M8x10	130	64
536392	40.0	-40 to 100	A	40	103	M8x10	130	64
536393	45.0	-40 to 100	A	40	103	M8x10	130	64
536394	50.0	-40 to 100	A	45	103	M8x10	160	49
536395	55.0	-40 to 100	A	45	103	M8x10	160	49
536396	60.0	-40 to 100	A	45	103	M8x10	200	49
380-450 V, 50/60 Hz								
536397	13.0	-40 to 85	A	35	103	M8x10	115	81
536398	18.0	-40 to 85	A	40	103	M8x10	130	64
536399	28.0	-40 to 85	A	45	103	M8x10	130	49
536400	32.0	-40 to 85	A	45	103	M8x10	130	49
536401	37.0	-40 to 85	A	50	103	M12x12	220	36
536402	50.0	-40 to 85	A	55	103	M12x12	240	36
536403	55.0	-40 to 85	B	50	128	M12x12	250	36
536404	60.0	-40 to 85	B	55	128	M12x12	250	36
536405	85.0	-40 to 85	B	60	138	M12x12	300	36

1

2

3

4

5

6

7

8

9

10

Parallel Connected Capacitors 250 V, 50/60 Hz

Capacitors type A

Casing: plastics, white or aluminium

Fastening: male nipple

with nut and washer included

Discharge resistance

Optional: thermal cut-out,

European wide patent

On request with alternative capacities,

connection terminals, mounting options,

casing materials or with a thermal fuse

as well as versions with IDC terminal for

the automatic luminaire wiring

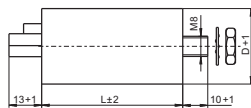

Ref. No.	Capacity µF	Temperature range °C	Ø (D) mm	Length (L) mm	Male nipple/ length (mm)	Push-in twin terminals	Weight g	Unit pcs.
Plastic casing								
500296	2.0	-40 to 85	25	57	M8x10	0.5-1 mm ²	22	530
500299	2.5	-40 to 85	25	57	M8x10	0.5-1 mm ²	22	530
500300	3.0	-40 to 85	25	57	M8x10	0.5-1 mm ²	22	530
500301	3.5	-40 to 85	25	57	M8x10	0.5-1 mm ²	22	530
500302	4.0	-40 to 85	25	70	M8x10	0.5-1 mm ²	29	450
500303	4.5	-40 to 85	25	70	M8x10	0.5-1 mm ²	29	450
500304	5.0	-40 to 85	25	70	M8x10	0.5-1 mm ²	29	450
500305	6.0	-40 to 85	25	70	M8x10	0.5-1 mm ²	29	450
506495	7.0	-40 to 85	30	70	M8x10	0.5-1 mm ²	35	320
502783	8.0	-40 to 85	30	70	M8x10	0.5-1 mm ²	35	320
504351	9.0	-40 to 85	30	70	M8x10	0.5-1 mm ²	35	320
508667	10.0	-40 to 85	30	70	M8x10	0.5-1 mm ²	39	320
506366	12.0	-40 to 85	30	94	M8x10	0.5-1 mm ²	43	260
508468	15.0	-40 to 85	30	94	M8x10	0.5-1 mm ²	43	260
508668	16.0	-40 to 85	30	94	M8x10	0.5-1 mm ²	48	260
500315	18.0	-40 to 85	35	94	M8x10	0.5-1.5 mm ²	55	190
500316	20.0	-40 to 85	35	94	M8x10	0.5-1.5 mm ²	62	190
500317	25.0	-40 to 85	40	94	M8x10	0.5-1.5 mm ²	66	80
500318	30.0	-40 to 85	40	94	M8x10	0.5-1.5 mm ²	72	100
Aluminium casing								
500319	32.0	-40 to 85	35	135	M8x10	0.5-1.5 mm ²	70	50
500320	35.0	-40 to 85	40	135	M8x10	0.5-1.5 mm ²	135	36
500321	40.0	-40 to 85	40	135	M8x10	0.5-1.5 mm ²	139	36
536406	45.0	-40 to 85	40	135	M8x10	0.5-1.5 mm ²	139	36
500322	50.0	-40 to 85	45	135	M8x10	0.5-1.5 mm ²	154	32
500323	55.0	-40 to 85	45	135	M8x10	0.5-1.5 mm ²	159	32

Parallel Connected Capacitors with Leads 250 V, 50/60 Hz

Capacitors type A

Casing: plastics, white
 Fastening: male nipple with nut and washer included
 Discharge resistance
 Fixing centres: 20 mm
 Optional: thermal cut-out, European wide patent
 On request with alternative capacities, connection terminals, mounting options, casing materials or with a thermal fuse as well as versions with IDC terminal for the automatic luminaire wiring

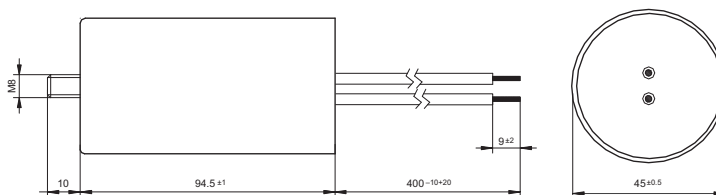

Ref. No.	Capacity μF	Temperature range °C	Ø (D) mm	Length (L) mm	Male nipple/ length (mm)	Lead length mm	Weight g	Unit pcs.
Plastic casing								
552774	2.0	-25 to 85	25	57	M8x10	150	22	400
526169	4.0	-25 to 85	28	54	M8x10	250	32	350
526170	6.0	-40 to 85	25	70	M8x10	250	32	320
526171	8.0	-40 to 85	35	57	M8x10	250	35	220
529665	10.0	-40 to 85	30	70	M8x10	200	40	280
536742	12.0	-25 to 85	36	67	M8x10	150	47	120
529666	16.0	-25 to 85	36	92	M8x10	200	52	120
536741	20.0	-40 to 85	35	95	M8x10	150	63	160
508484	25.0	-25 to 85	40	70	M8x10	250	72	80
536743	30.0	-25 to 85	40	92	M8x10	150	82	80
528554	35.0	-25 to 85	45	94.5	M8x10	250	85	60
536813	40.0	-25 to 85	45	94.5	M8x10	400	85	60
528555	45.0	-25 to 85	50	94.5	M8x10	250	90	50

1

2

3

4

5

6

7

8

9

10

4

Capacitors for Fluorescent and Discharge Lamps

Idle current compensation	261
Parallel compensation	262
MPP capacitor technology	262–264
Assembly instructions – Capacitors	265–266
Capacitor tables	267–268
General technical details	366–374
Glossary	375–377

Compensation of idle current

When using magnetic ballasts a phase shift occurs between the mains voltage and the current drawn. This phase shift is expressed by the power factor λ , which generally ranges between a value of 0.3 and 0.7 with inductive circuits.

As a result of this phase shift, idle current, which does not boost the efficiency of the lighting unit, is also taken up from the power supply network in addition to real power. Power utility companies therefore require an increase of the power factor to values of over 0.85 for systems exceeding a certain rating (usually upwards of 250 W per external conductor).

Compensation capacitors are used to counteract idle current (by increasing the power factor) and can be connected either in parallel or in series.

Thanks to a power factor of approx. 0.95, electronic ballasts do not need to be operated with compensation capacitors.

Compensation using series capacitors

Series compensation employs a so-called dual circuit (two fluorescent lamp circuits connected in parallel), whereby the capacitor, which is connected in a branch of the circuit, over compensates the inductive idle current to such an extent that it covers the idle current of both ballasts. This type of circuit is only used with fluorescent lamps. As series capacitors are dimensioned for nominal-voltage and ballast tolerances, the lamp in the capacitor branch of the dual circuit operates with a higher current and thus also with a higher rating. Apart from differences in lamp brightness, the power loss in the circuit branch with the capacitor will also be greater.

An advantage of the dual circuit is that it prevents the radiated light from flickering.

The higher current in the so-called capacitive lamp circuit causes an up to 14% increase in lamp rating and a reduction of the lamp service life by as much as 20%. This goes hand in hand with substantial technical, ecological and economic disadvantages.

Series capacitors have to meet very high technical requirements to suit various aspects like temperature, nominal voltage, tolerances of the capacitance values, etc.

As defined by EC directive 2000/55/EC (European Standard EN 50294 governing the measurement of total power consumption), a series capacitor is considered to be a part of the ballast. If the system rating of the capacitive circuit containing the lamps and ballasts is then determined in line with the above definition, rating increases of up to 14% will become apparent in comparison to operation without a series capacitor. Experience has shown that this increased power consumption often means devices fall in the directive's "banned" category. It is therefore strongly advised that due consideration be given to the elevated power consumption values common to using series capacitors for compensation purposes.

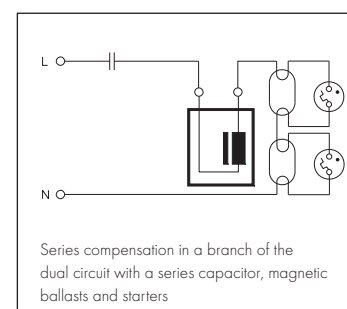

1

2

3

4

5

6

7

8

9

10

Parallel compensation

During parallel compensation, each lamp circuit is assigned to a capacitor connected in parallel to the mains. Only one capacitor providing sufficient capacitance is needed for luminaires with several lamps. Parallel compensation does not affect current flow through a discharge lamp. The requirements placed on parallel capacitors are clearly lower than those for series capacitors.

However, parallel compensation can be subject to limitations when using audio-frequency ripple control pulses if the system operates with a connected rating of over 5 kVA and ripple control frequencies of over 300 Hz are used. The respective power utility company should be consulted for advice in such cases.

Parallel compensation is used in fluorescent lamp and high-pressure discharge lamp circuits.

As parallel compensation offers substantial advantages, this has become the accepted method in the last few years.

Metallised polypropylene film capacitors

Metallised polypropylene film capacitors are designed to compensate the inductive idle current drawn by discharge lamps (fluorescent lamps, high-pressure mercury vapour lamps, high-pressure sodium vapour lamps and metal halide lamps with a ceramic discharge tube) in 50 Hz/60 Hz grids. All Vossloh-Schwabe compensation capacitors for luminaires feature a metallised polypropylene film dielectric. Compensation capacitors help to increase the power factor to values of over λ 0.85 as required by power utility companies.

Construction of metallised polypropylene film capacitors

VS MPP capacitors contain a low-loss metallised polypropylene film dielectric, which is produced by depositing a thin layer of zinc and aluminium or pure aluminium vapour onto one side of the polypropylene film. The contacts at either end of the capacitor coil are created by spraying on a layer of metal and thus guarantee a high current-carrying capacity as well as a low-inductive connection between the terminals and the coils.

All capacitors with a nominal voltage upwards of 280 V are filled with oil or resin after the coils have been inserted and then hermetically sealed. This protects the coils from environmental influences and reduces partial discharge, which contributes to a long service life and stable capacitance. The effects of partial discharge only play a minor role for capacitors with a nominal voltage of under 280 V so that these devices do not need to be filled.

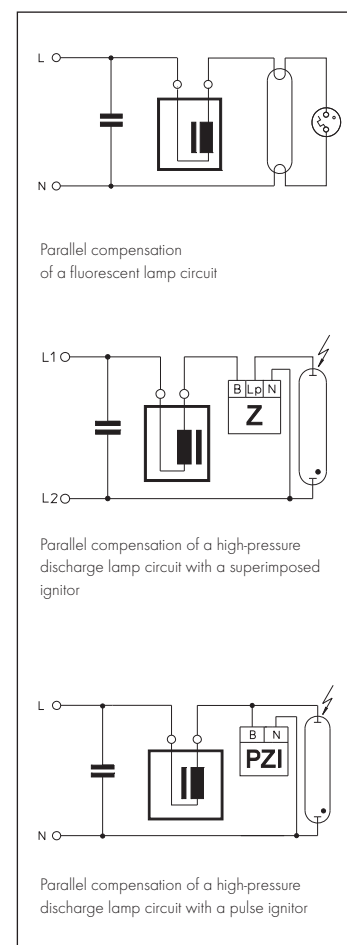

Hermetically sealed, filled capacitors with an overpressure contact breaker should always be used in critical ambient conditions (high humidity, aggressive atmospheres, high temperatures), if the workload and power supply conditions are unknown as well as in situations that demand increased attention to safety.

VS MPP capacitors feature a self-healing dielectric. In the event of a dielectric breakdown in the coil (short circuit), the metal coating vaporises around the breakdown site owing to the high temperature of the transient arc that is produced. Owing to the excess pressure generated during such a breakdown, the metal vapour is pushed outwards away from the centre of the site within the space of just a few microseconds. This creates a coating-free corona around the breakdown site that completely isolates it and means the capacitor remains fully functional during a dielectric breakdown.

The self-healing properties of a capacitor can decrease with time and with constant overloading. This bears the risk of a non-healing breakdown with a permanent short circuit. Therefore self-healing must not be confused with failsafe.

Compensation capacitors are divided into two type families (A and B) in accordance with IEC 61048 A2.

- Type A capacitors defined:
"Self-healing parallel capacitors; without an (overpressure) contact breaker in the event of failure".
They are referred to as unsecured capacitors.
- Type B capacitors defined:
"Self-healing capacitors for series connection in lighting circuits or self-healing parallel capacitors; with an (overpressure) contact breaker in the event of failure".
These are referred to as hermetically sealed, secured capacitors.

In accordance with the standard, the discharge resistor of both capacitor families must be capable of reducing capacitor voltage to a value of under 50 V in the space of 60 seconds after disconnection from the mains.

Capacitors without a contact breaker, unsecured, Type A capacitors in accordance with IEC 61048 A2

IEC 61048 A2-compliant Type A capacitors are self-healing and require no short-circuit protection for normal operation.

Type A capacitors are not fitted with a specific failsafe mechanism as prescribed by the standards for Type B capacitors. Nevertheless, the requirements laid down in the standard for Type A capacitors, especially with regard to temperature and service life tests, are designed to ensure a sufficient degree of device safety and availability **provided the device was correctly installed and operated under calculable and known ambient operating conditions.**

Even so, in very rare cases these capacitors can still develop erratic behaviour due to overloading or at the end of the device's service life.

For that reason, Type A capacitors should only be integrated into luminaires for operation in ambient conditions that are uncritical with regard to flammable materials. Luminaires should feature protection against secondary damage inside and outside the luminaire in the event of a defect.

1

2

3

4

5

6

7

8

9

10

Technical Details – Capacitors for Fluorescent and Discharge Lamps

Temperature-protected capacitors are a further development of Type A capacitors and are fitted with a thermal fuse that is triggered by overheating as a result of electrical or thermal overloading. They are tested in accordance with IEC 61048 A2 and comply with Type A requirements. Excess temperatures cause the two wire ends of the element inside the fuse to melt into bead shapes that are fully isolated from each other by special insulation.

In 99% of all the rare cases of critical capacitor failure, this failure is preceded by a gradual increase in the loss factor, which leads to an increase in the winding temperature and thus triggers the thermal fuse.

Vossloh-Schwabe recommends that preference be given to Type A capacitors with a thermal fuse as a matter of course for reasons of safety.

Type A capacitors predominantly feature a plastic casing.

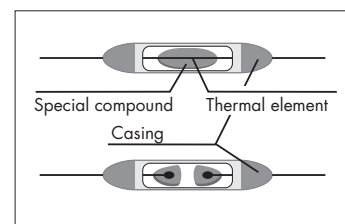

Capacitors with a contact breaker, secured Type B capacitors in accordance with IEC 61048 A2

Self-healing capacitors do not require short-circuit protection for normal operation as they automatically regenerate after a dielectric breakdown. However, as a result of frequent self-healing caused by overloading (voltage, current, temperature) or towards the end of the capacitor's service life, overpressure can build up inside the capacitor (due to the decomposition products of the vaporised polypropylene).

In order to prevent the capacitor casing from exploding in such cases, hermetically sealed capacitors in accordance with IEC 61048 A2 (Type B capacitors) are fitted with an overpressure contact breaker. If excess pressure builds up within these capacitors, e.g. due to undue thermal loading or excessive voltages or at the end of the capacitor's service life, a concertina section opens out that causes the casing to expand lengthways. As a result, the wire contacts rupture at a predetermined breaking point, which irreversibly interrupts the current (contact breaker).

This type of overpressure-protected capacitor with a contact breaker is also referred to as a flame- and explosion-proof capacitor with a break-action mechanism.

Type B capacitors with a contact breaker are available in an aluminium casing.



Assembly Instructions for Capacitors

For mounting and installing compensation capacitors

Mandatory regulations

DIN VDE 0100	Erection of low voltage installations
EN 60598	Luminaires – part 1: General requirements and tests
EN 55015	Maximum values and testing methods for radio disturbance of electrical lighting facilities and similar electrical equipment
EN 61000-3-2	Electromagnetic Compatibility (EMC) – part 3: maximum values – main section part 2: maximum values for mains harmonics (ballast input current up to and including 16 A per conductor)
EN 61048	Operating devices for lamps – capacitors for fluorescent lamp circuits and other discharge lamp circuits; general and safety requirements
EN 61049	Operating devices for lamps – capacitors for fluorescent lamp circuits and other discharge lamp circuits; performance requirements

Mechanical mounting

Fastening	Base screw (permissible torque): <ul style="list-style-type: none">• M8x10 – 5 Nm (aluminium casing)• M8x10 – 2.2 Nm (plastic casing)
Mounting location	Any Capacitors fitted with overpressure protection require clearance of at least 10 mm above the contacts so ensure the casing can expand unhindered if the contact breaker is triggered.
Heat transfer	Capacitors should be mounted with the greatest possible clearance to heat sources or lamps. During operation, the temperature measured at the t_c point must not exceed the specified maximum value.
t_c point	The t_c point is defined as an arbitrary point on the surface of the capacitor, which is not specifically marked.
UV Radiation	Capacitors should not be installed in an unprotected manner directly next to any sources of light, heat radiation or convection (ballasts, lamps, heating elements, etc.) as both high temperatures and constant exposure to UV radiation can lead to premature ageing. In combination with high temperatures, UV radiation or other substances and influencing factors, chemicals such as ozone and chlorine can lead to accelerated ageing and material embrittlement.
Thermal load	All capacitor casings are made of flame-retardant materials. However, the potting material, oils and the winding material are flammable and consideration must be taken of this fact during installation. The thermal load of an MKP capacitor is approx. 40 MJ/kg.

1

2

3

4

5

6

7

8

9

10

Safety functions

Type A capacitors are not fitted with any special protective functions in case of defect.

Temperature-protected capacitors are a further development of Type A capacitors and feature a thermal fuse that is triggered by excess temperatures and disconnects the capacitor from the mains.

Type B capacitors are fitted with an overpressure contact breaker in case of defects at the end of the capacitor's service life.

Connection

Parallel capacitors for fluorescent lamps:

- Casing diameter 25–30 mm: push-in terminals for 0.5–1 mm² conductors and IDC terminals for H05V-U 0.5 conductors
- Casing diameter > 30 mm: push-in terminals for 0.5–1 mm² conductors

Parallel capacitors for high-pressure lamps:

- Casing diameter 25–30 mm: push-in terminals for 0.5–1 mm² conductors and IDC terminals for H05V-U 0.5 conductors
- Casing diameter > 30 mm: push-in terminals for 0.5–1.5 mm² conductors

Reliability and service life

Provided the max. specified voltage and current loads, temperature, humidity and mains harmonics values are observed,

- approx. 50,000 hours for overpressure-protected parallel capacitors
- approx. 30,000 hours for parallel capacitors without overpressure protection in a plastic or aluminium casing

A 3–10% decrease in capacitance must be expected in the course of the capacitor's service life.

Failure rate: 1‰ per 1,000 operating hours when maximum voltage, current and temperature values are not exceeded.

Electrical installation

Nominal voltage 250 V, 50/60 Hz; 280 V, 50/60 Hz; 450 V, 50/60 Hz
(dependent on type)

Capacitance tolerance

±10% (±5% dependent on type)

Temperature range

–25/–40 °C to +85/+100 °C (dependent on type, details see product page)

Optional thermal fuse

Relative humidity Class F for Type B capacitors: 75% annual mean, 95% peak value on 30 days
Class G for Type A capacitors: 65% annual mean, 85% peak value on 30 days

Condensation Impermissible

Capacitors for fluorescent lamp circuits

Lamp Output W	Type	Parallel compensation capacitor ($\mu\text{F} \pm 10\%$ at 250 V)		Series compensation capacitor ($\mu\text{F} \pm 4\%$)		
		220-240 V/50 Hz μF	220-230 V/60 Hz μF	220 V/50 Hz μF	230 V/50 Hz μF	220 V/60 Hz μF
4	T	2**	2**	–	–	–
6	T	2**	2**	–	–	–
8	T	2**	2**	–	–	–
10	T	2	2	–	–	–
13	T	2	2	–	–	–
14	T	4.5	4.5	–	–	–
15	T	3.5 or 4*	3 or 4*	–	–	–
16	T	2	2	–	–	–
18	T	4.5 or 4*	4**	2.9/440 V	2.8/480 V	2.4/440 V
20	T	4.5 or 4*	4**	2.9/440 V	2.8/480 V	2.4/440 V
23	T	3.5	3	–	–	–
25	T	3.5	3	–	2.3/450 V	–
30	T	4.5	4	3/420 V	2.9/450 V	–
36	T	4.5	4	3.6/420 V	3.4/450 V	3/420 V
36-1m	T	6.5	–	–	–	–
38	T	4.5	4	–	–	–
40	T	4.5	4	3.6/420 V	3.4/450 V	3/420 V
42	T	6.5	–	–	–	–
58	T	7	6	5.7/450 V	5.3/450 V	4.8/420 V
65	T	7	6	5.7/450 V	5.3/450 V	4.8/420 V
70	T	6	–	–	–	–
75	T	6	–	–	–	–
80	T	9	8	–	7.2/420 V	–
85	T	8	6.5	–	8.4/420 V	–
100	T	10	9	–	–	–
115	T	18	16	–	–	–
140	T	14	14	–	–	–
160	T	14	14	–	–	–
16	T-U	2	2	–	–	–
18/20	T-U	4.5 or 4*	4**	2.9/440 V	2.8/480 V	2.4/440 V
36/40	T-U	4.5	4	3.6/420 V	3.4/450 V	3/420 V
58/65	T-U	7	6	–	–	–
22	T-R	5	4.5	–	3.2/440 V	–
32	T-R	5	4.5	–	3.4/450 V	–
40	T-R	4.5	4	3.6/420 V	3.4/450 V	3/420 V
5/7/9/11	TC-S	2**	2**	–	–	–
10	TC-D/TC-T	2	2	–	–	–
13	TC-D/TC-T	2	2	–	–	–
18	TC-D/TC-T	2	2	–	–	–
26	TC-D/TC-T	3.5	3	–	–	–
10	TC-DD	2	2	–	–	–
16	TC-DD	2	2	–	–	–
21	TC-DD	3	3	–	–	–
28	TC-DD	3.5	3	–	–	–
38	TC-DD	4.5	4	–	–	–
18	TC-L/TC-F	4.5 or 4*	4**	–	–	–
24	TC-L/TC-F	4.5	4	–	–	–
34	TC-L/TC-F	4.5	4	–	–	–
36	TC-L/TC-F	4.5	4	–	–	–

*) Two lamps connected to a ballast in series

**) Applies to one lamp connected to a ballast or two lamps connected in series

1

2

3

4

5

6

7

8

9

10

Technical Details – Capacitors for Fluorescent and Discharge Lamps

Capacitors for

Lamp		Compensation capacitor ($\mu\text{F} \pm 10\%$)			
Output W	Type	220/230/240/252 V 50 Hz (μF)	220 V 60 Hz (μF)	380/400/420 V, 50 Hz (μF)	380 V/60 Hz 60 Hz (μF)

high-pressure mercury vapour lamp circuits

50	HM	7	6		
80	HM	8	7		
125	HM	10	10		
250	HM	18	15		
400	HM	25	25		
700	HM	40	35		
1000	HM	60	50		

high-pressure sodium vapour lamp circuits

35	HS	6	5		
50	HS	8	8		
70	HS	12	10		
100	HS	12	10		
150	HS	20	16		
250	HS	32	25		
400	HS	45	40		
600	HS	65	55	25	20
750	HS	70	60	25	25
1000	HS	100	85		

metal halide lamp circuits

35	HI	6	5		
70	HI	12	10		
100	HI	12	10		
150	HI	20	16		
250	HI	32	25		
400	HI	35/45	35/45		
1000	HI	85	75		
2000	HI	125	125		
2000	HI			37	37
2000	HI			60	60
2000	HI			60	60
2000	HI			100	100

Capacitors for low-pressure discharge lamp circuits

Lamp		Compensation capacitor ($\mu\text{F} \pm 10\%$)
Output W	Type	230 V/50 Hz μF
35	LS	20
55	LS	20
90	LS	26
135	LS	40
180	LS	40

1

2

3

4

5

6

7

8

9

10

ELECTRONIC AND ELECTRO- MAGNETIC TRANSFORMERS

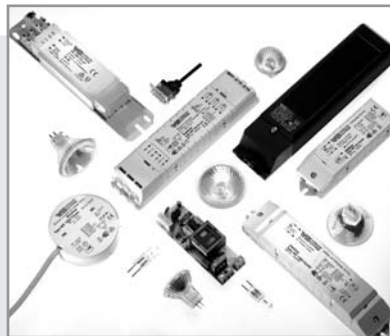

FOR LOW-VOLTAGE HALOGEN INCANDESCENT LAMPS

The operating voltage of low-voltage halogen lamps is normally 12 V (6 and 24 V are also used for special applications). As a result, transformers are required in order to connect such lamps to the normal mains supply within buildings, whereby international requirements governing building installations specify that safety transformers or converters (electronic transformers) be exclusively used for such purposes nowadays. These devices are designed in such a way as to prevent both personal injury and the outbreak of fire should the lighting system malfunction.

Electronic converters

The following chapter provides an overview of the VS range of electronic converters that feature a whole range of advantages: light and compact, superior efficiency (approx. 95%), short-circuit protection, integrated overheating and overload protection, soft start for longer lamp life, broad part-load range and dimmability.

Electromagnetic safety transformers

The following chapter also provides an overview of Vossloh-Schwabe's range of electromagnetic transformers. The range is split into protection class II transformers and protection class I built-in transformers whose ultra-flat design make them particularly user-friendly. Lamp brightness can be regulated using conventional phase dimmers for low-voltage halogen lamps.



5

Transformers for Low-voltage Halogen Incandescent Lamps

Independent electronic converters	272
Electronic built-in converters	273–274
Electromagnetic safety transformers	275
Technical details for incandescent lamps	333–345
General technical details	366–374
Glossary	375–377

1

2

3

4

5

6

7

8

9

10

Independent Electronic Converters – LiteLine

Electronic safety converters for low-voltage halogen incandescent lamps 12 V

Casing: heat-resistant polyamide

Mains frequency: 50–60 Hz

Protection against "no load" operation

Protection against short-circuit:

electronic switch-off with automatic restart

Electronically controlled overload

and temperature protection

Suitable for installation in furniture

and on combustible surfaces

Power factor: > 0.95

Efficiency: ≥ 94%

Dimming: optional with phase-cutting leading-edge or phase-cutting trailing-edge dimmer

Screw terminals: 2.5 mm²

(EST 60/12.635 primary: 4 mm²)

Quantity of screw terminals:

1x 2-poles primary

1x 2-poles secondary

With integrated cord grip

Protection class II

SELV

Degree of protection: IP20

RFI-suppressed

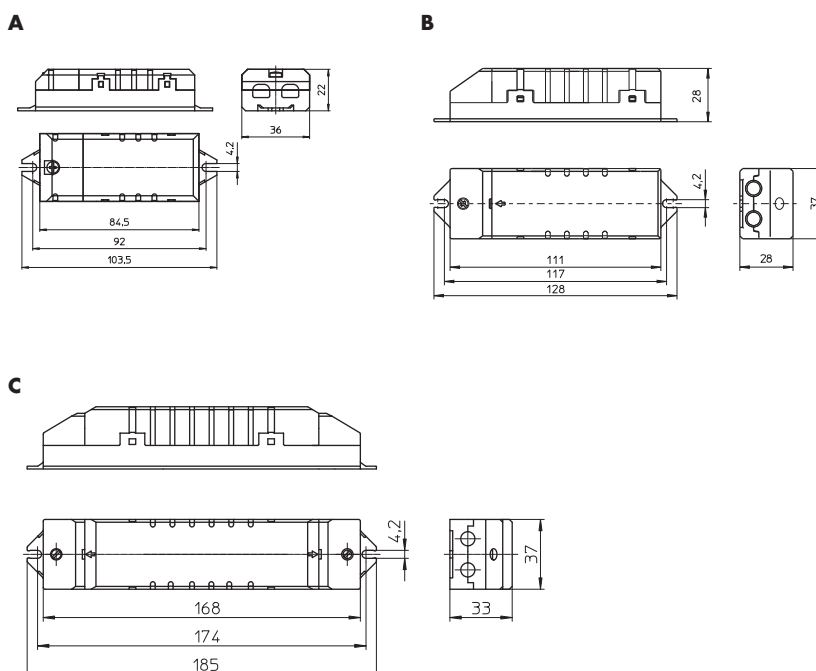

Type	Ref. No.	Capacity range (W)	Voltage (V) prim. (±10%)	sec.	Nominal current A	Ambient temperature t_a (°C)	Casing temperature t_c (°C)	Drawing	Weight g
Dimensions: 22x36x103.5 mm									
EST 60/12.635	186173	10-60	220-240	10.2-12	0.258-0.260	-20 to 45	max. 85	A	70
Dimensions: 28x37x128 mm									
EST 70/12.380	186072	20-70	230-240	11.3-11.7	0.30-0.31	-20 to 45	max. 70	B	85
EST 105/12.381	186077	20-105	230-240	11.2-11.7	0.435-0.445	-20 to 40	max. 85	B	95
Dimensions: 33x37x185 mm									
EST 150/12.622	186098	50-150	230-240	11.2-11.6	0.595-0.605	-20 to 45	max. 85	C	175

Super-thin Electromagnetic Built-in Transformers 20–105 VA

Shape: 28 x 41 mm

Electromagnetic safety transformers
for low-voltage halogen incandescent lamps 12 V
Vacuum-impregnated with polyester resin
Screw terminals: 0.5–2.5 mm²
Protection class I
For these transformers without thermal cut-out,
a slow-acting fuse should be installed in the
wiring on site

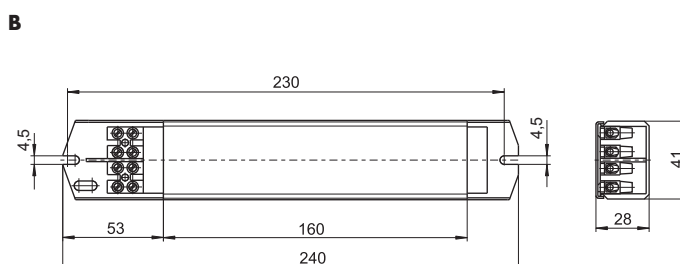
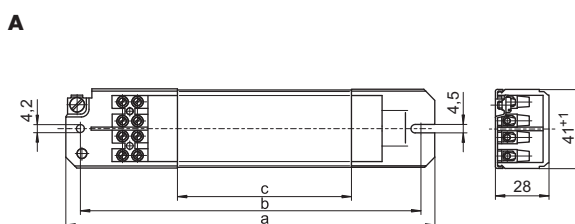
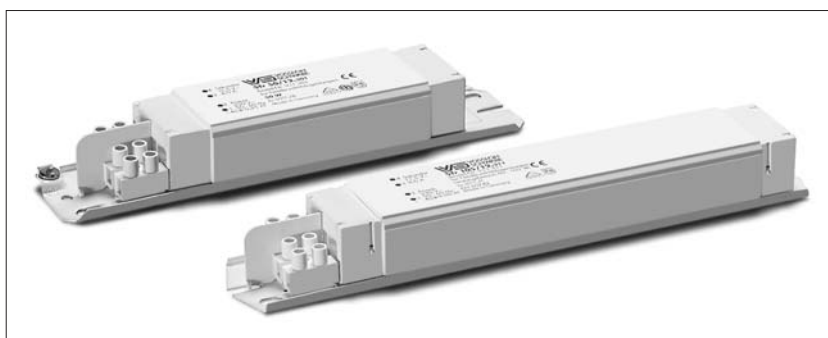

Safety transformers											Primary fuse
Type	Ref. No.	Capacity range W	50, 60 Hz V prim.	50, 60 Hz V sec.	Ambient temperature t _a (°C)	Drawing	a mm	b mm	c mm	Weight kg	AT
220 V/50, 60 Hz											
STr 50/12.207	500843	35–50	220	11.5	40/B	A	175	165	83	0.73	0.250
230 V/50, 60 Hz											
STr 20/12.306	161781	15–20	230	11.5	60/B	A	155	140	63	0.55	0.125
STr 50/12.301	161757	35–50	230	11.5	50/B	A	195	180	92	0.80	0.250
STr 50/12.342	507181	35–50	230	11.5	40/B	A	175	165	83	0.73	0.250
STr 60/12.338	179604	40–60	230	11.5	50/F	A	195	180	92	0.80	0.315
STr 105/12.311	170002	60–105	230	11.5	30/F	B	240	230	160	1.33	0.500
240 V/50, 60 Hz											
STr 50/12.401	169830	35–50	240	11.5	45/B	A	195	180	92	0.80	0.250
STr 50/12.422	502592	35–50	240	11.5	40/B	A	175	165	83	0.73	0.250
STr 105/12.406	169125	60–105	240	11.5	50/H	B	240	230	160	1.33	0.500
127 V/60 Hz											
STr 50/12.109	525791	35–50	127	11.5	40/F	A	155	140	63	0.55	0.500

1

2

3

4

5

6

7

8

9

10

Super-thin Electromagnetic Built-in Transformers with Thermal Cut-out 20–105 VA

Shape: 28 x 41 mm

Electromagnetic safety transformers
for low-voltage halogen incandescent lamps 12 V
Vacuum-impregnated with polyester resin
Screw terminals: 0.5–2.5 mm²
Protection class I
Temperature switch with self-holding protection
against overheating,
no primary fuse necessary

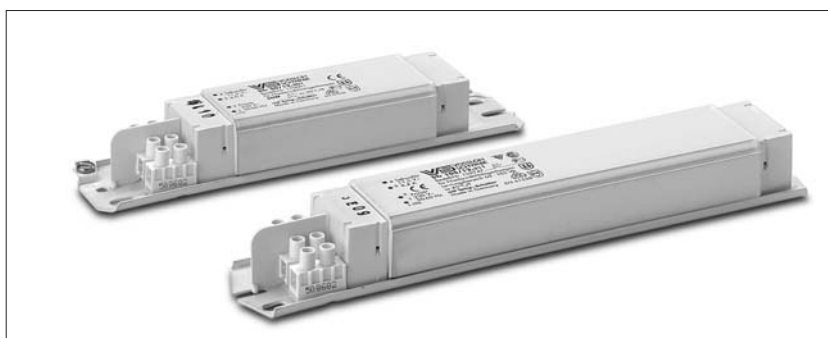

A

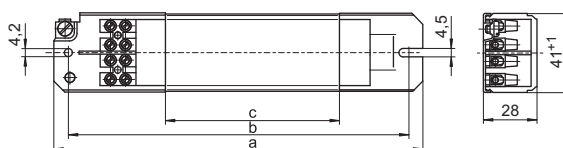

B

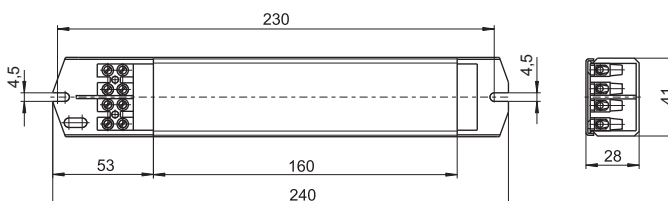

Type	Ref. No.	Capacity range W	50, 60 Hz		Ambient temperature t_g (°C)	Drawing	a mm	b mm	c mm	Weight kg
			V prim.	V sec.						
230 V/50, 60 Hz										
STr 20/12.306	161860	15–20	230	11.5	60/B	A	155	140	63	0.55
STr 50/12.337	179444	35–50	230	11.5	50/F	A	175	165	83	0.73
STr 50/12.301	170091	35–50	230	11.5	50/B	A	195	180	92	0.80
STr 60/12.338	179608	40–60	230	11.5	50/F	A	195	180	92	0.80
STr 105/12.311	169747	60–105	230	11.5	45/F	B	240	230	160	1.33
240 V/50, 60 Hz										
STr 50/12.401	169748	35–50	240	11.5	45/B	A	195	180	92	0.80
STr 105/12.406	161935	60–105	240	11.5	50/H	B	240	230	160	1.33
127 V/60 Hz										
STr 50/12.109	537403	35–50	127	11.5	40/F	A	155	140	63	0.55

Compact Electromagnetic Transformers 70–300 VA

Shape: 85 x 85 mm (200 VA)

Shape: 99 x 85 mm (300 VA)

Built-in electromagnetic safety transformers
for low-voltage halogen incandescent lamps 12 V
Fully encapsulated transformer in a plastic casing

Mains frequency: 50–60 Hz

Built-in primary fuse and temperature switch

Connections

primary: lead

secondary: screw terminals up to 6 mm²

Degree of protection: IP24

Protection class II

Suitable for installation in furniture
and on combustible surfaces

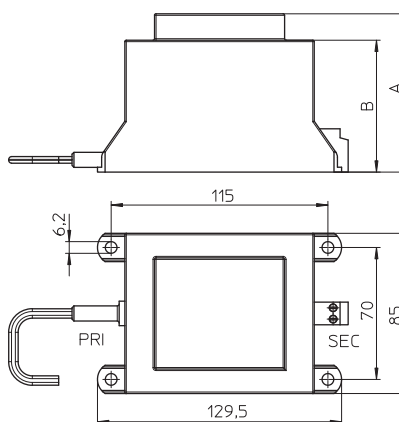

Type	Ref. No.	Capacity range W	Voltage AC V - 10%+6%		Ambient temperature t_a °C	A mm	B mm	Weight kg
			prim.	sec.				
230 V/50, 60 Hz								
STr 200/12.40	554325	70 - 200	230	12	40	85	70	2.9
STr 300/12.41	554326	150 - 300	230	12	40	99	84	3.9

1

2

3

4

5

6

7

8

9

10

LOW- AND MAINS VOLTAGE LAMP HOLDERS



LAMP HOLDERS FOR HALOGEN INCANDESCENT LAMPS

As the tungsten-halogen cycle and the high lamp current can cause very high temperatures when operating low-voltage halogen lamps, close attention must be paid to the luminaire's thermal conditions and components must be made of high-grade materials.

VS lampholders for low-voltage halogen lamps

The following chapter contains Vossloh-Schwabe's comprehensive range of connection elements, lampholders and accessories for safe and reliable installation in accordance with the latest regulations and developments.

VS lampholders for mains voltage halogen lamps

The following chapter contains Vossloh-Schwabe's comprehensive range of lampholders for single-ended halogen lamps (GU/GZ10 and G9 bases), lampholders for bayonet lamps (B15d and B22d bases) as well as lampholders for double-ended tubular lamps (R7s base).



Lampholders for low-voltage halogen incandescent lamps

G4, GZ4, G5.3, GX5.3, G6.35, GY6.35 lampholders, accessories

G4 lampholders, GZ4 lamp connectors

Lampholders with separate mounting spring for GU4 lamps

GX5.3 lamp connectors

GU5.3 lampholders

Lampholders with separate mounting spring for GU5.3 lamps

G6.35, GY6.35 lampholders, GZ6.35 lamp connectors

G53 lamp connectors

278–285

278–279

279–281

282

283

283–284

284–285

285

285

Lampholders for mains voltage halogen incandescent lamps

B15d, BA15d lampholders

G9 lampholders, accessories

GU10, GZ10 lampholders, accessories

R7s ceramic lampholders

R7s metal lampholders

Connection boxes

Connectors

286–295

286

286–288

289–290

291–293

293

294

295

Technical details for incandescent lamps

General technical details

Glossary

296–345

366–374

375–377

1

2

3

4

5

6

7

8

9

10

G4, GZ4, G5.3, GX5.3, G6.35, GY6.35 Lampholders, Accessories

For low-voltage halogen incandescent lamps

The lampholders listed in this chapter permit the use of lamps with different bases. It is important to ensure that under no circumstances a lamp

with a smaller pin diameter is used if a lamp with a larger pin diameter has already been used.

G/GZ4, G/GX5.3, G/GY6.35 lampholder
 Casing: LCP, natural, T270
 Nominal rating: 8/24 (for G4/GZ4 lamps: 4/24)
 Multipoint contacts: CuNiZn
 Push-in terminals for stranded conductors with ferrule on bare end of core \varnothing 1.4-1.8 mm
 Fixing holes for screws M3
 Weight: 2.4 g, unit: 1000 pcs.
 Type: 33300
Ref. No.: 109547

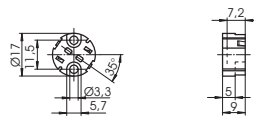

Cover caps
 For push-fit onto lampholders type 333
 External thread 20.8x2
 Material: LCP, natural
 Moulded thread: M10x1
 Weight: 3.8 g, unit: 1000 pcs.
 Type: 97255
Ref. No.: 109548

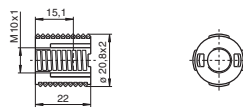

Screw rings
 For components with external thread 20.8x2
 Weight: 1.7/1.4 g, unit: 1000 pcs.
 Type: 97257
Ref. No.: 109550 PPS, black
Ref. No.: 507490 LCP, natural

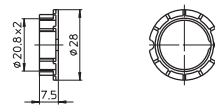

G/GZ4, G/GX5.3, G/GY6.35 lampholder
 Casing: LCP, natural, T270
 Nominal rating: 8/24 (for G4/GZ4 lamps: 4/24)
 Multipoint contacts: CuNiZn
 Push-in terminals for stranded conductors with ferrule on bare end of core \varnothing 1.4-1.8 mm
 Fixing holes for screws M3
 Weight: 2.6 g, unit: 1000 pcs.
 Type: 33400
Ref. No.: 109674

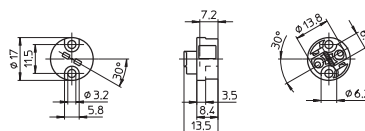

Lampholders for Halogen Incandescent Lamps

G/GZ4, G/GX5.3, G/GY6.35 lampholder

Casing: ceramic, cover plate: mica

T350

Nominal rating: 10/24

Contacts: Ni

Leads: Cu nickel-plated, stranded conductors

0.75 mm², PTFE-insulation, length: 140 mm

Fixing holes for screws M3

Weight: 6.8 g, unit: 500 pcs.

Type: 32400

Ref. No.: 100939

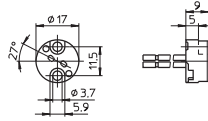

1

2

G/GZ4, G/GX5.3, G/GY6.35 lampholder

Casing: ceramic, cover plate: mica

T300

Nominal rating: 10/24

Multipoint contacts: CuNiZn

Leads: Cu nickel-plated, stranded conductors

0.75 mm², PTFE-insulation, length: 140 mm

Fixing holes for screws M3

Weight: 7.1 g, unit: 1000 pcs.

Type: 32700

Ref. No.: 101258

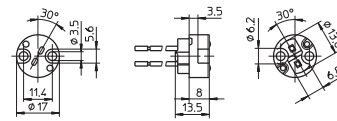

3

4

G/GZ4, G/GX5.3, G/GY6.35 lampholder

Casing: ceramic, cover plate: mica

T300, nominal rating: 10/24

Multipoint contacts: CuNiZn

Leads: Cu nickel-plated, stranded conductors

0.75 mm², PTFE-insulation, length: 140 mm

Fixing plate: zinc-coated polished steel

Fixing holes for screws M3

Weight: 8.8 g, unit: 1000 pcs.

Type: 32720

Ref. No.: 101274

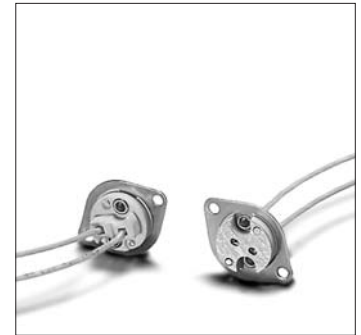
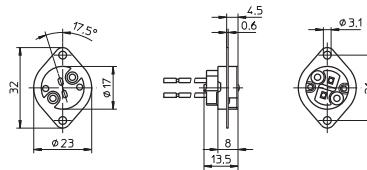

5

6

G4 Lampholders, GZ4 Lamp Connectors

For low-voltage halogen incandescent lamps

G4 lampholder, GZ4 lamp connector

Casing: PPS, black, T240

Nominal rating: 4/24, multipoint contacts: steel

Leads: Cu tinned, stranded conductors 0.75 mm²,

Si-insulation, length: 140 mm

Option for lateral wiring

Lampholder height: 16 mm

Fixing holes for screws M3

Weight: 5.7 g, unit: 1000 pcs.

Type: 30400

Ref. No.: 530024

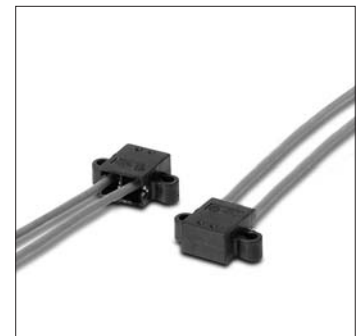
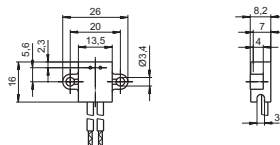

7

8

9

10

Lampholders for Halogen Incandescent Lamps

G4 lampholder, GZ4 lamp connector

Casing: PPS, black, T240

Nominal rating: 4/24, multipoint contacts: steel

Leads: Cu tinned, stranded conductors 0.75 mm²,

Si-insulation, length: 140 mm

Lampholder height: 12.8 mm

Fixing holes for screws M3

Weight: 5.5 g, unit: 1000 pcs.

Type: 30450

Ref. No.: 530025

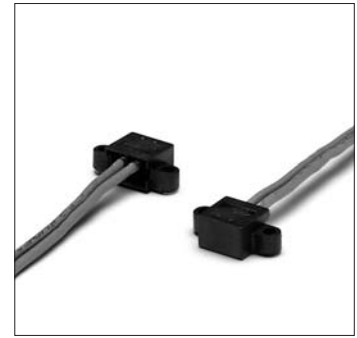
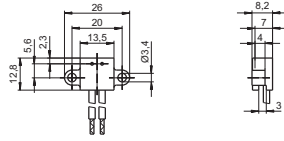

G4 lampholder, GZ4 lamp connector

Casing: PPS, black, T240

Nominal rating: 4/24, multipoint contacts: steel

Leads: Cu tinned, stranded conductors 0.75 mm²,

Si-insulation, length: 140 mm

Option for lateral wiring

Lampholder height: 16 mm

For push-fit onto the lamp

Weight: 5.3 g, unit: 1000 pcs.

Type: 30460

Ref. No.: 530026

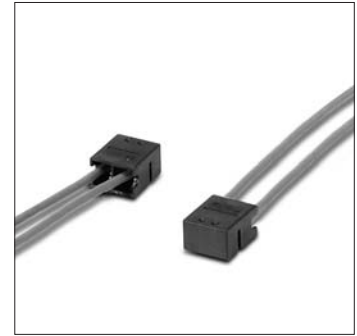
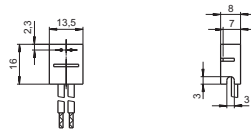

G4 lampholder, GZ4 lamp connector

Casing: PPS, black, T240

Nominal rating: 4/24, multipoint contacts: steel

Leads: Cu tinned, stranded conductors 0.75 mm²,

Si-insulation, length: 140 mm

Option for lateral and base wiring

Lampholder height: 12.8 mm

For push-fit onto the lamp

Weight: 5.1 g, unit: 1000 pcs.

Type: 30465

Ref. No.: 530027

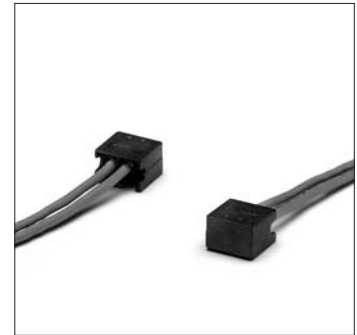
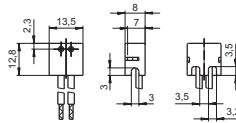

G4 lampholders

For push-fit into lampholder support 535267

T240

Nominal rating: 2/50

Multipoint contacts: CuNiZn

Push-in terminals for stranded conductors

with ferrule on bare end of core Ø 1.4-1.8 mm

Weight: 1.5/1.6 g, unit: 1000 pcs.

Type: 30800

Ref. No.: 535146 material: LCP

Ref. No.: 535263 material: PPS

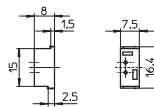

Lampholder support for G4 lampholders type 30800

Material: polyamide

Base split pins for wall thickness 0.6 mm

Weight: 0.8 g, unit: 500 pcs.

Type: 95300

Ref. No.: 535267

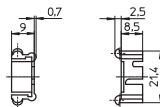

Lampholders with Separate Mounting Spring for GU4 Lamps

For low-voltage halogen incandescent lamps

G/GZ4, G/GX5.3, G/GY6.35 lampholder
 Casing: LCP, natural, T270
 Nominal rating: 8/24 (for G4/GZ4 lamps: 4/24)
 Multipoint contacts: CuNiZn
 Push-in terminals for stranded conductors
 with ferrule on bare end of core \varnothing 1.4-1.8 mm
 Fixing holes for screws M3
 For cover cap (see p. 278)
 Weight: 2.4 g, unit: 1000 pcs.
 Type: 33300

Ref. No.: 109547

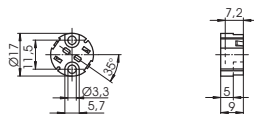

GU4 mounting spring for lamp
 Material: stainless steel
 For push-fit onto lampholders type 333 and 32210
 Weight: 0.8 g, unit: 1000 pcs.
 Type: 94095

Ref. No.: 109553

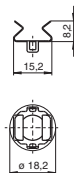

G/GZ4, G/GX5.3, G/GY6.35 lampholder
 Casing: ceramic, cover plate: mica
 T350
 Nominal rating: 10/24
 Contacts: Ni
 Leads: Cu nickel-plated, stranded conductors
 0.75 mm², PTFE-insulation, length: 140 mm
 Fixing holes for screws M3
 Weight: 6.8 g, unit: 500 pcs.
 Type: 32400

Ref. No.: 100939

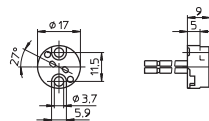

GU4 mounting spring for lamp
 Material: stainless steel
 The mounting spring has to be fastened
 to the lampholder 100939.
 The luminaire manufacturer is responsible
 for the attachment.
 Weight: 1.6 g, unit: 1000 pcs.
 Type: 94071

Ref. No.: 108678

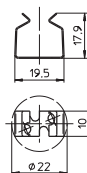

GX5.3 Lamp Connectors

For low-voltage halogen incandescent lamps

GX5.3 lamp connector

Casing: ceramic, cover plate: mica

T300, nominal rating: 10/24

Multipoint contacts: Ni

Leads: Cu nickel-plated, stranded conductors

1 mm², PTFE-insulation, length: 145 mm

Fixing holes for screws M3

Weight: 13.3 g, unit: 1000 pcs.

Type: 32020

Ref. No.: 400548

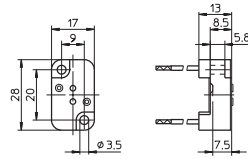

GX5.3 lamp connectors

Casing: ceramic, cover plate: mica

T300, nominal rating: 10/24

Multipoint contacts: Ni

Leads: Cu nickel-plated, stranded conductors

0.75 mm², PTFE-insulation, length: 140 mm

Weight: 7.8/8.5 g, unit: 500 pcs.

Type: 32600 holes for screws M3

Ref. No.: 101162

Type: 32620 threaded bushes M3

Ref. No.: 101207

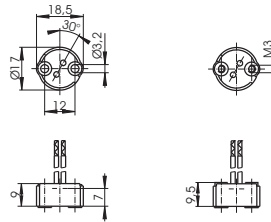

GU5.3 Lampholders

For low-voltage halogen incandescent lamps

GU5.3 lampholder

Casing: ceramic, cover plate: mica

T350, nominal rating: 10/24

Contacts: Ni

Leads: Cu nickel-plated, stranded conductors

0.75 mm², PTFE-insulation, length: 140 mm

Fixing holes for screws ST2.9

Mounting spring for lamp: stainless steel

Weight: 9.1 g, unit: 1000 pcs.

Type: 32480

Ref. No.: 106457

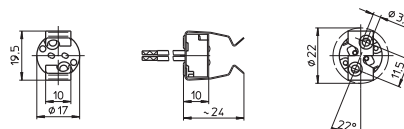

1

2

3

4

5

6

7

8

9

10

Lampholders for Halogen Incandescent Lamps

GU5.3 lampholders

Casing: ceramic, cover plate: mica
 T300, nominal rating: 10/24, multipoint contacts: Ni
 Leads: Cu nickel-plated, stranded conductors
 0.75 mm², PTFE-insulation, length: 140 mm

Mounting spring for lamp: stainless steel

Weight: 11/12 g, unit: 500 pcs.

Type: 32680 holes for screws M3

Ref. No.: 101248

Type: 32690 threaded bushes M3

Ref. No.: 101253

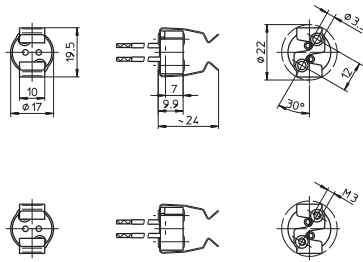

Lampholders with Separate Mounting Spring for GU5.3 Lamps

For low-voltage halogen incandescent lamps

G/GZ4, G/GX5.3, G/GY6.35 lampholder

Casing: LCP, natural, T270

Nominal rating: 8/24 (for G4/GZ4 lamps: 4/24)

Multipoint contacts: CuNiZn

Push-in terminals for stranded conductors with ferrule on bare end of core \varnothing 1.4-1.8 mm

Fixing holes for screws M3

For cover cap (see p. 279)

Weight: 2.4 g, unit: 1000 pcs.

Type: 33300

Ref. No.: 109547

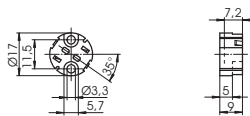

GU5.3 mounting spring for lamp

Material: stainless steel

For push-fit onto lampholders type 333

Weight: 1.1 g, unit: 1000 pcs.

Type: 94096

Ref. No.: 109554

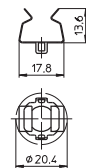

G/GZ4, G/GX5.3, G/GY6.35 lampholder

Casing: ceramic, cover plate: mica

T350

Nominal rating: 10/24

Contacts: Ni

Leads: Cu nickel-plated, stranded conductors

0.75 mm², PTFE-insulation, length: 140 mm

Fixing holes for screws M3

Weight: 6.8 g, unit: 500 pcs.

Type: 32400

Ref. No.: 100939

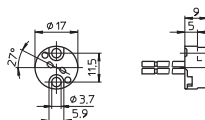

Lampholders for Halogen Incandescent Lamps

GU5.3 mounting spring for lamp

Material: stainless steel

The mounting spring has to be fastened to the lampholder 100939.

The luminaire manufacturer is responsible for the attachment.

Weight: 2 g, unit: 1000 pcs.

Type: 94060

Ref. No.: 106256

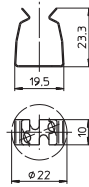

1

2

3

G6.35, GY6.35 Lampholders, GZ6.35 Lamp Connectors

For low-voltage halogen incandescent lamps

G/GY6.35 lampholder, GZ6.35 lamp connector

Casing: ceramic, cover plate: mica

T300, nominal rating: 10/24

Multipoint contacts: Ni

Leads: Cu nickel-plated, stranded conductors

0.75 mm², PTFE-insulation, length: 140 mm

Fixing holes for screws M3

Lamp fixing holes: diagonal

Weight: 11 g, unit: 500 pcs.

Type: 30300

Ref. No.: 100662

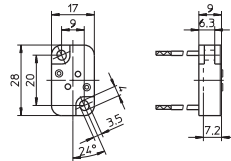

4

5

6

G53 Lamp Connectors

For low-voltage halogen incandescent lamps

G53 lamp connector

Casing: PPS, black

Nominal rating: 10/24

Contacts: CuNiZn

Lead: Cu tinned, stranded conductors 0.75 mm²,

Si-insulation, length: 140 mm

Fixing hole for screw M4

Lead exit: lateral

Weight: 4.4 g, unit: 1000 pcs.

Type: 33100

Ref. No.: 107694

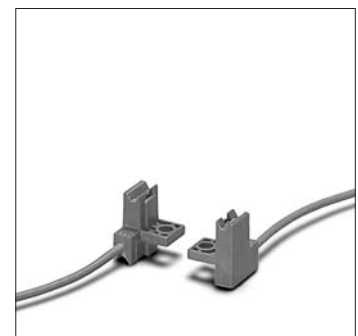
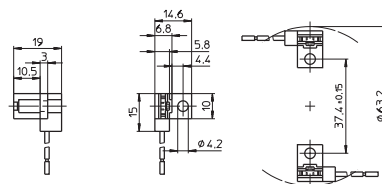

7

8

9

10

B15d, BA15d Lampholders

For low-voltage and mains voltage halogen incandescent lamps

One-piece contact pins with screw terminals to reduce voltage drop.

When using lampholders without cap it has to be ensured protection from electric shock as well as sufficient creepage distances and clearances from live parts on the back of lampholders.

B15d, BA15d lampholders

Casing with fixing flange: zinc-coated polished steel

Insert: ceramic, T230

Nominal rating: 8/250

Fixing holes for screws M3

Weight: 15/16 g, unit: 500 pcs.

Type: 78100

Ref. No.: 102923

Type: 78101 with earth terminal

Ref. No.: 102925

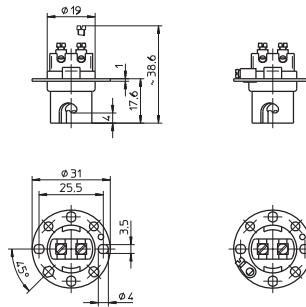

B15d, BA15d lampholder

Casing: zinc-coated polished steel

Insert: ceramic, T230, nominal rating: 8/250

With earth terminal

Cover cap: PBT GF, max. 180 °C

External thread 28x2 IEC 60399

For E14 metal screw rings

Weight: 17/11.5 g, unit: 500 pcs.

Type: 78201

Ref. No.: 106513 insert

Ref. No.: 106583 cap M10x1

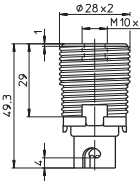

G9 Lampholders, Accessories

For mains voltage halogen incandescent lamps

For luminaires of protection class II

G9 lampholder

Casing: ceramic, cover plate: LCP, natural

T300, nominal rating: 2/250

Push-in twin terminals for stranded conductors with ferrule on bare end of core Ø 1.4-1.8 mm

Weight: 7.5 g, unit: 1000 pcs.

Type: 33800

Ref. No.: 509357

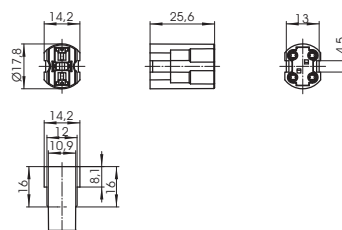

Lampholders for Halogen Incandescent Lamps

Metal screw rings

For components with external thread 20.8x2

Material: zinc-coated polished steel

Weight: 1.6/2 g, unit: 1000 pcs.

Type: 93034 Ø 27 mm, height: 7 mm

Ref. No.: 509110

Type: 93035 Ø 27 mm, height: 11 mm

Ref. No.: 509118

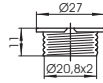
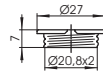

G9 lampholder

Casing: ceramic, cover plate: LCP, natural

T270, nominal rating: 2/250

Push-in twin terminals for stranded conductors with ferrule on bare end of core Ø 1.4-1.8 mm

Fixing holes for screws M3

Weight: 14.4 g, unit: 1000 pcs.

Type: 33500

Ref. No.: 502004

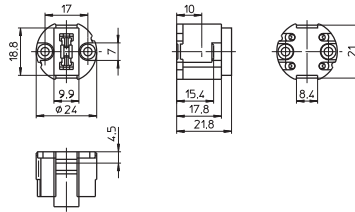

Cover caps for G9 lampholder 502004

Material: LCP, natural

External thread 28x2 IEC 60399

Fixing holes for screws M3

Weight: 8.7/4.6 g, unit: 1000 pcs.

Type: 83310 female nipple: M10x1

Ref. No.: 505951

Type: 97268 moulded thread: M10x1

Ref. No.: 501942

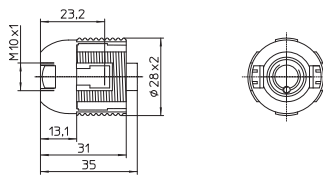

Screw ring

For components with external thread 28x2

Material: PPS, black

Ø 34 mm, height: 7.5 mm

Weight: 1.9 g, unit: 1000 pcs.

Type: 05202

Ref. No.: 502503

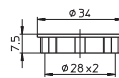

GU10, GZ10 Lampholders, Accessories

For mains voltage halogen incandescent lamps

GU10, GZ10 lampholders

Casing: LCP, natural, T270, nominal rating: 2/250

Push-in twin terminals for stranded conductors with ferrule on bare end of core \varnothing 1.4-1.8 mm

Fixing holes for screws M3

Weight: 7 g, unit: 1000 pcs.

Type: 31000/31010

Ref. No.: 108979 GU10, GZ10 lampholder

Ref. No.: 109007 GU10 lampholder

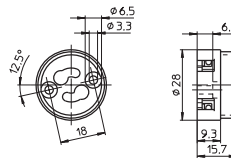

GU10, GZ10 lampholders

For luminaires of protection class II

Casing: LCP, natural, T270, nominal rating: 2/250

Push-in twin terminals for stranded conductors with ferrule on bare end of core \varnothing 1.4-1.8 mm

Fixing holes for screws M3

Weight: 8 g, unit: 1000 pcs.

Type: 31020/31030

Ref. No.: 502111 GU10, GZ10 lampholder

Ref. No.: 502112 GU10 lampholder

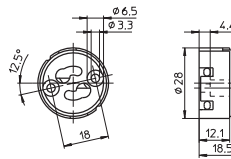

Cover cap for GU10, GZ10 lampholders type 310

Material: PA GF, black

Moulded thread: M10x1

Fixing holes for screws M3

Weight: 3.4 g, unit: 1000 pcs.

Type: 97244

Ref. No.: 109411

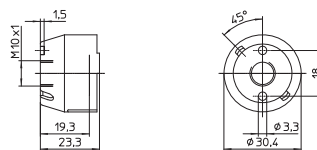

Cover cap for lampholders 502111/502112

External thread 32x2

Material: LCP, natural

Moulded thread: M10x1

Weight: 6 g, unit: 1000 pcs.

Type: 97320

Ref. No.: 502064

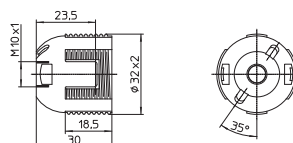

1

2

3

4

5

6

7

8

9

10

Lampholders for Halogen Incandescent Lamps

Screw ring

For components with external thread 32x2

Ø 38.9 mm, height: 7.5 mm

Material: PPS, black

Weight: 2.3 g, unit: 1000 pcs.

Type: 97282

Ref. No.: 502416

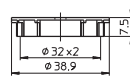

GU10, GZ10 lampholders

Casing: steatite, cover plate: PPS

T240, nominal rating: 2/250

Push-in terminals for stranded conductors with ferrule on bare end of core Ø 1.5–1.8 mm

Fixing holes for screws M3

Weight: 13.6/14 g, unit: 500 pcs.

Type: 31755/31705

Ref. No.: 535034 GU10, GZ10 lampholder

Ref. No.: 535032 GU10 lampholder

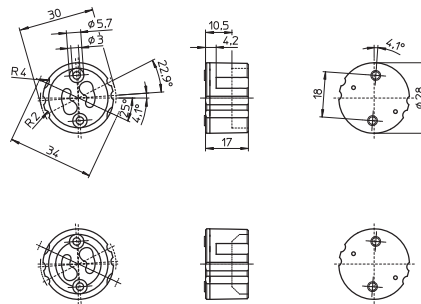

Cover caps for lampholders type 315/317

Material: PBT GF

Front fixing holes for self-tapping

screws acc. to ISO 1481/7049-ST2.9-C/F

Cord grip: twist and block (for single-core leads)

Rear lead exit: max. Ø 2.5 mm

Weight: 6.9 g, unit: 500 pcs.

Type: 97765

Ref. No.: 536164 black

Ref. No.: 543615 grey

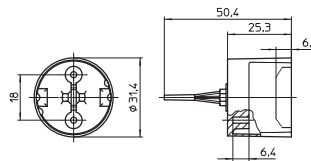

GU/GZ10 Lampholder set

For luminaires of protection class II

Casing lampholder: steatite, cover plate: PPS

T240, nominal value: 2/250

Cover cap with cord grip: PBT GF

Leads: Cu, stranded conductors

0.5 mm², double FEP-insulation, length: 150 mm

Weight: 25 g, unit: 500 pcs.

Type: 31760

Ref. No. 554662

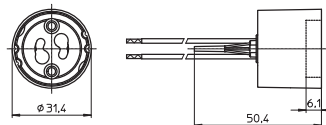

R7s Ceramic Lampholders

For mains voltage halogen incandescent lamps

The luminaire design must ensure protection from electric shock as well as sufficient creepage distances and clearances from live parts on the back of lampholder.

If the central hole on the bracket is used for fixing there must be a support within the luminaire to ensure that the bracket cannot be deformed.

Partly enclosed R7s lampholder

Casing: ceramic, T350

Contact pin: Cu, silver bulb

Nominal rating: 8/250

Leads: Cu nickel-plated, stranded conductors

0.75 mm², PTFE-insulation, length: 200 mm

With fixing screw M4

Weight: 25.4 g, unit: 400 pcs.

Type: 32300

Ref. No.: 100912

Partly enclosed R7s lampholder

Casing: ceramic, T350

Contact pin: Cu, silver bulb

Nominal rating: 8/250

Leads: Cu nickel-plated, stranded conductors

0.75 mm², PTFE-insulation, length: 200 mm

Oblong holes for screws M3/M4

Central hole for screw M4

Weight: 59.3 g, unit: 200 pcs.

Type: 32390 contact distance: 74.9 mm

Ref. No.: 107213

Partly enclosed R7s lampholder

Casing: ceramic, T350

Contact pin: Cu, silver bulb

Nominal rating: 8/250

Leads: Cu nickel-plated, stranded conductors

0.75 mm², PTFE-insulation, length: 200 mm

Oblong holes for screws M3/M4

Central hole for screw M4

Weight: 61 g, unit: 200 pcs.

Type: 32391 contact distance: 74.9 mm

Ref. No.: 107214

Partly enclosed R7s lampholder

Casing: ceramic, T350

Contact pin: Cu, silver bulb

Nominal rating: 8/250

Leads: Cu nickel-plated, stranded conductors

0.75 mm², PTFE-insulation, length: 200 mm

Oblong holes for screws M3/M4

Central hole for screw M4

Weight: 61.3 g, unit: 200 pcs.

Type: 32395 contact distance: 74.9 mm

Ref. No.: 107215

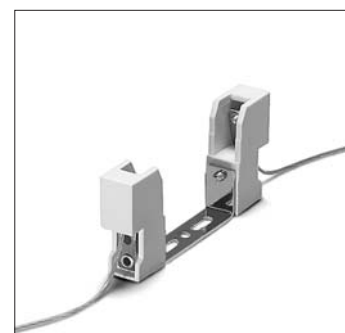
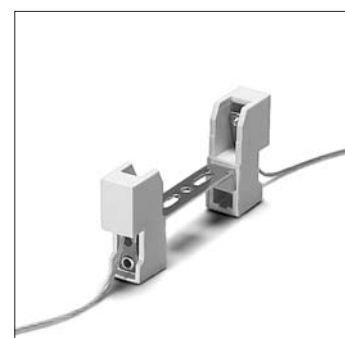
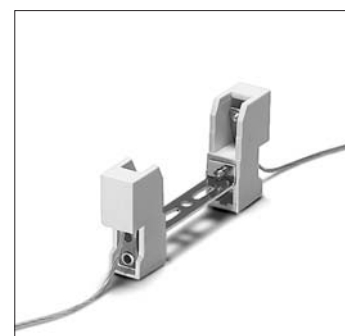
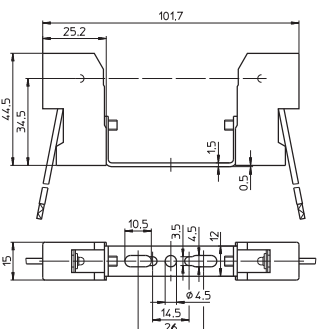
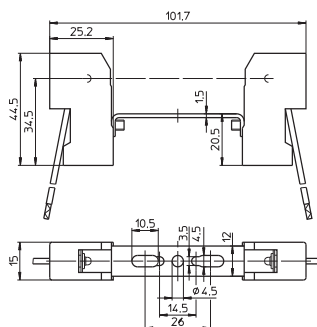
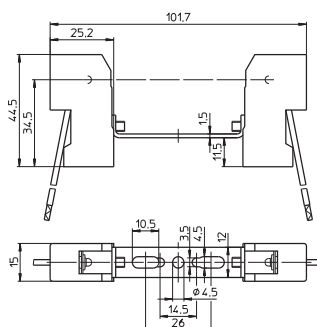
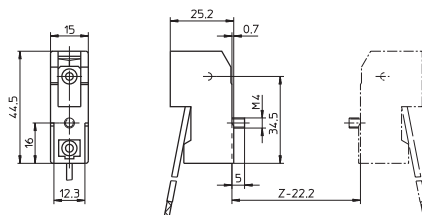

1

2

3

4

5

6

7

8

9

10

Lampholders for Halogen Incandescent Lamps

Partly enclosed R7's lampholder

Casing: ceramic, T350

Contact pin: Cu, silver bulb

Nominal rating: 8/250

Leads: Cu nickel-plated, stranded conductors

0.75 mm², PTFE-insulation, length: 200 mm

Oblong holes for screws M4

Central hole for screw M4

Weight: 64.9 g, unit: 200 pcs.

Type: 32310 contact distance: 114.2 mm

Ref. No.: 107195

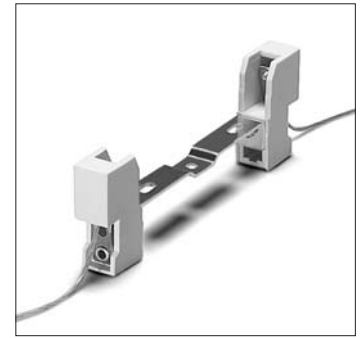
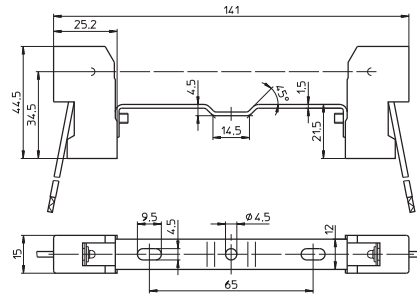

Partly enclosed R7's lampholder

Casing: ceramic, T350

Contact pin: Cu, silver bulb

Nominal rating: 8/250

Leads: Cu nickel-plated, stranded conductors

0.75 mm², PTFE-insulation, length: 200 mm

Oblong holes for screws M4

Central threaded bush M4

Weight: 66.5 g, unit: 200 pcs.

Type: 32320 contact distance: 114.2 mm

Ref. No.: 107194

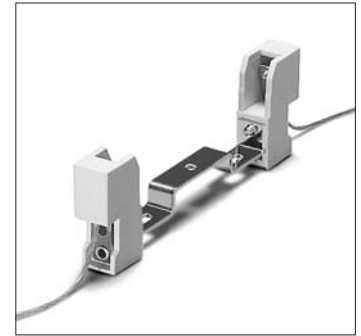
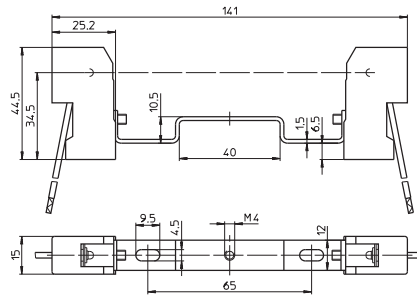

Partly enclosed R7's lampholder

Casing: ceramic, T350

Contact pin: Cu, silver bulb

Nominal rating: 8/250

Leads: Cu nickel-plated, stranded conductors

0.75 mm², PTFE-insulation, length: 200 mm

Oblong holes for screws M4

Central hole for screw M4

Weight: 65.4 g, unit: 200 pcs.

Type: 32340 contact distance: 114.2 mm

Ref. No.: 107193

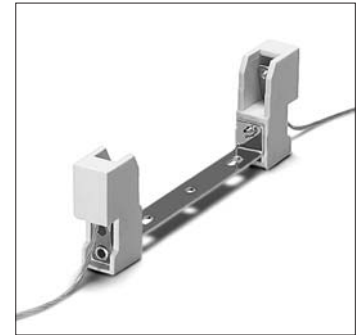
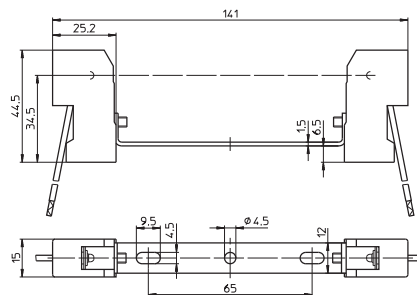

Partly enclosed R7's lampholder

Casing: ceramic, T350

Contact pin: Cu, silver bulb

Nominal rating: 8/250

Leads: Cu nickel-plated, stranded conductors

0.75 mm², PTFE-insulation, length: 200 mm

Oblong holes for screws M4

Central hole for screw M5

Weight: 66.7 g, unit: 200 pcs.

Type: 32360 contact distance: 114.2 mm

Ref. No.: 107192

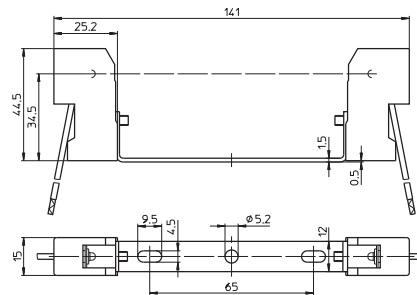

Partly enclosed R7's lampholder

Casing: ceramic, T350

Contact pin: Cu, silver bulb

Nominal rating: 8/250

Leads: Cu nickel-plated, stranded conductors

0.75 mm², PTFE-insulation, length: 200 mm

Oblong holes for screws M4

Central hole for screw M5

Weight: 71.3 g, unit: 200 pcs.

Type: 32380 contact distance: 114.2 mm

Ref. No.: 109497

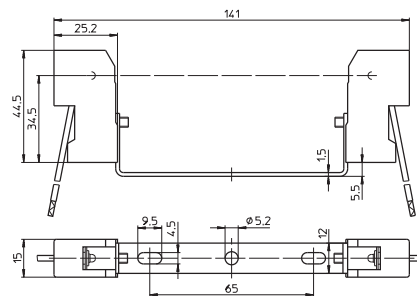

Lampholders for Halogen Incandescent Lamps

Protection cap for R7s lampholders
 For push-fit onto lampholders type 323
 Protection against electrical shock
 on the rear side of the lampholder
 Lampholder with assembled protection cap on request
 Material: LCP, natural
 Weight: 0.7 g, unit: 1000 pcs.
 Type: 97528
Ref. No.: 507592

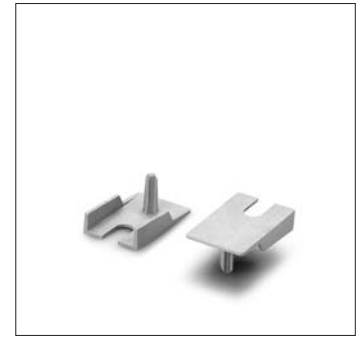
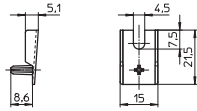

1

2

3

4

R7s Metal Lampholders

For mains voltage halogen incandescent lamps

R7s lampholder
 Casing: Al, T300, contact pin: Ni
 Nominal rating: 10/250
 Lead: Cu nickel-plated, stranded conductors
 0.75 mm², PTFE-insulation, length: 300 mm
 Fixing flange
 Fixing holes for screws M4
 Weight: 21 g, unit: 50 pcs.
 Type: 30023
Ref. No.: 100616

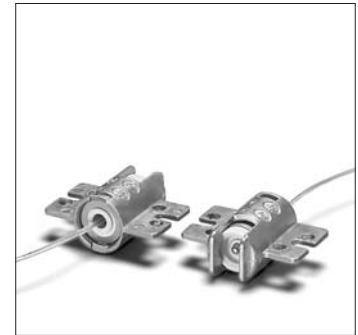
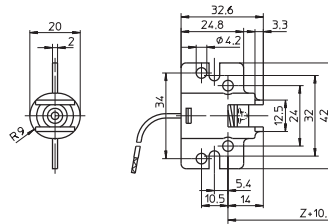

5

6

R7s lampholder
 Casing: Al, T300, contact pin: Cu, silver bulb
 Nominal rating: 10/250
 Lead: Cu nickel-plated, stranded conductors
 1 mm², PTFE-insulation, length: 300 mm
 Fixing flange
 Fixing holes for screws M3
 Weight: 15.7 g, unit: 1000 pcs.
 Type: 30523
Ref. No.: 100710

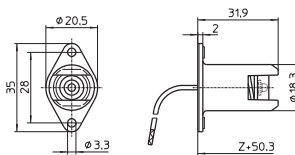

7

8

R7s lampholder
 Casing: Al, T300, contact pin: Cu, silver bulb
 Nominal rating: 10/250
 Lead: Cu nickel-plated, stranded conductors
 1 mm², PTFE-insulation, length: 350 mm
 Fixing bracket
 Fixing holes for screws M4
 Weight: 24.8 g, unit: 500 pcs.
 Type: 30550
Ref. No.: 100720

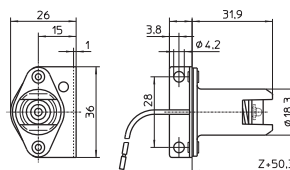

9

10

Connection Boxes

For connecting downlights in false ceilings according to standards
The luminaire manufacturer is responsible for the right choice of accessories.

Application examples for connection box

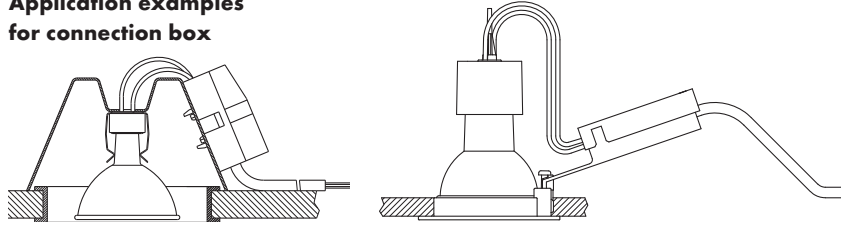

Connection box
Material: PC, black
Split pins for wall thickness 0.5–1.5 mm
With integrated 2-pole terminal block and contact bushings: 2.5 mm²
With cord grip
Weight: 18 g, unit: 500 pcs.
Type: 85007
Ref. No.: 108940

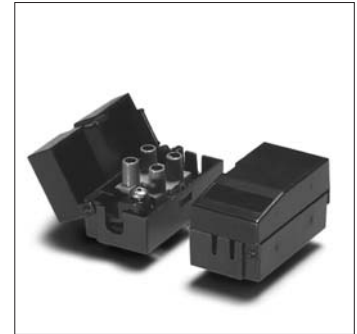
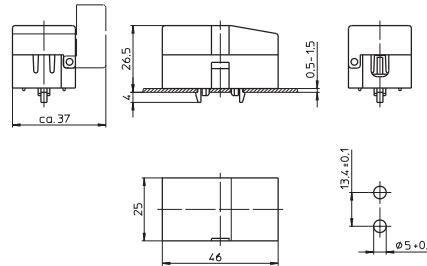

Connection boxes
Material: PA, black
With integrated 2-pole terminal block for leads with cross-section: 0.5–2.5 mm²
Cord grip on primary side for leads
H03VV-F/H05VV-F (Ø 5–7 mm) and single-core Ø 3–7 mm
Cord grip on secondary side for
single-core Teflon leads up to Ø 3 mm
and single-core PVC leads up to Ø 2.2 mm
Weight: 21.8/20.1 g, unit: 500 pcs.
Type: 85011/85012 plastic bracket with locking screw
Ref. No.: 543048 12 V
Ref. No.: 543049 230 V
Type: 85013/85014 for fixing screw
Ref. No.: 543053 12 V
Ref. No.: 543054 230 V

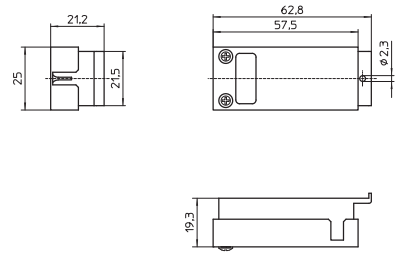
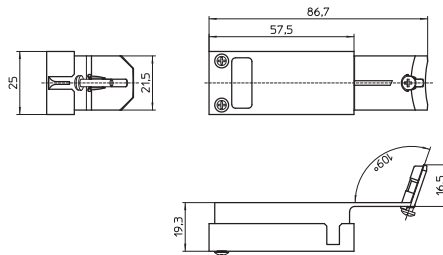

Connection boxes
With plastic bracket with locking screw
Material: PA, black
With integrated 3-pole terminal block for leads with cross-section: 0.75–4 mm²
Cord grip on primary side for leads Ø 2.5–11 mm
Cord grip on secondary side for
single-core Teflon leads up to Ø 1.8 mm
and single-core PVC leads up to Ø 2.2 mm
Weight: 28.7 g, unit: 500 pcs.
Type: 85015/85016
Ref. No.: 543058 12 V
Ref. No.: 543059 230 V

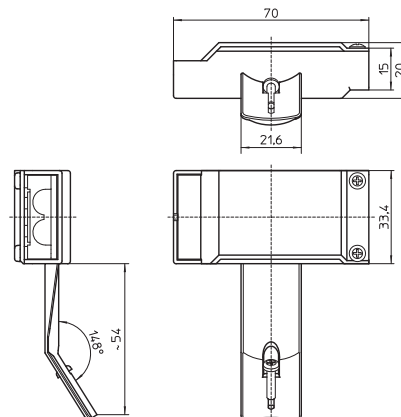

Connectors

Modular system for various assembly options
Connectors can be delivered pre-assembled
with lampholder and lead assemblies

Male and female plug
Nominal rating: 7/600
For cable: 0.3–0.9 mm²
For crimping on the end of lead
Material: brass, tinned
Weight: 0.1 g, unit: 5000 pcs.

Type: 93088 male plug

Ref. No.: 505251

Type: 93089 female plug

Ref. No.: 506807

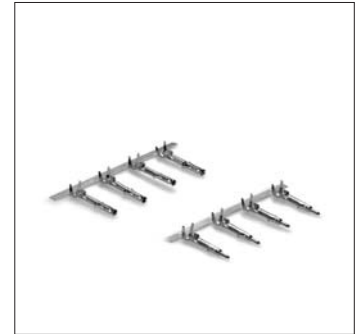
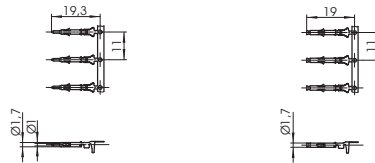

Male and female casing
For male and female plug
For push-fit assembly
Material: PA, natural

Weight: 0.8/1 g, unit: 2500 pcs.

Type: 97355 male casing

Ref. No.: 509295 UL94V-0

Ref. No.: 508562 UL94V-2

Type: 97356 female casing

Ref. No.: 509296 UL94V-0

Ref. No.: 508563 UL94V-2



1

2

3

4

5

6

7

8

9

10

LAMPHOLDERS MADE OF THERMOPLASTICS, METAL AND PORCELAIN

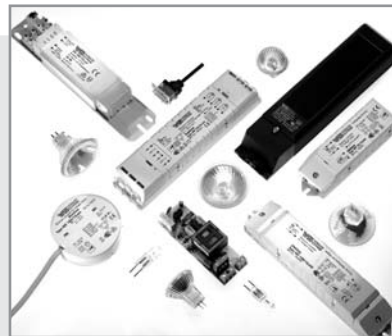

LAMPHOLDERS FOR GENERAL-SERVICE INCANDESCENT AND RETROFIT LAMPS

The general-service light bulb owes its name to its bulbous shape, which has remained almost unchanged to this day. The tungsten filament contained within the bulb's glass shell, in which there used to be a vacuum but which is nowadays more usually filled with an inert gas, begins to glow as electricity is passed through it. Despite the considerable technical progress that has been made, the typical disadvantages associated with light bulbs still remain. For instance, incandescent lamps mainly radiate heat with no more than 5-10% light output and have a service life of approx. 1000 operating hours.

As a result of energy-efficiency regulations in the various regions of the world, the use of all-purpose incandescent lamps has been limited or even banned. Nonetheless, thanks to the many different shapes and surfaces of lamp bulbs, all-purpose incandescent lamps still have a firm place in decorative residential lighting applications and are often an important feature of luminaire designs. Retrofit lamps that comply with energy-efficiency regulations are increasingly being used as a replacement for all-purpose incandescent lamps and use the same lampholder systems found with E12/E14, E26/E27, E39/E40, B15d and B22d bases.

VS lampholders for general-service incandescent and retrofit lamps

Depending on the operating conditions, lampholders can be made of thermoplastics, metal or porcelain. Metal lampholders are most often used for high-grade decorative luminaires. In accordance with protection class I, metal lampholders must be included in the measures taken to earth the luminaire.

Due to their heat resistance, Edison lampholders made of porcelain are frequently used for higher-output lamps. Classic lampholder materials like metal and porcelain are increasingly being displaced by modern thermoplastics.



E14 lampholders

E14 thermoplastic lampholders, one-piece and cover caps	
E14 table lamp set	
E14 thermoplastic lampholders, three-piece	
E14 metal lampholders, three-piece	
E14 thermoplastic rocker switch lampholders	

E27 lampholders

E27 thermoplastic lampholders, one-piece and cover caps	
E27 table lamp set	
E27 renovation kit lampholders	
E27 thermoplastic lampholders, three-piece	
E27 porcelain lampholders	
E27 metal lampholders, three-piece	
E27 thermoplastic pull-switch lampholders	
E27 metal pull-switch lampholders	
E27 thermoplastic rocker switch lampholders	
E27 festoon lampholders	

B22d lampholders, accessories**Accessories for E14, E27 and B22d lampholders****E40 porcelain lampholders****Technical details for incandescent lamps**

General technical details	
Glossary	

298–307

298–302	
303	
303–305	
306	
307	

307–324

307–312	
313	
313	
314–316	
317–318	
319	
320–321	
321–322	
322–323	
323–324	

324–325**326–331****332****333–345**

366–374	
375–377	

1

2

3

4

5

6

7

8

9

10

E14 Thermoplastic Lampholders, One-piece

For incandescent lamps with base E14

E14 lampholders with temperature marking

T180 on request.

Brass-finished versions are available on request.

E14 lampholders, for cover caps

Plain casing

Casing: PET GF, T210, nominal rating: 2/250

Push-in twin terminals: 0.5–1.5 mm²

Rear fixing holes for self-tapping screws

acc. to ISO 1481/7049-ST2.9-C/F

Weight: 11.3/11.4 g, unit: 1000 pcs.

Type: 64001

Ref. No.: 109384 white

Ref. No.: 109383 black

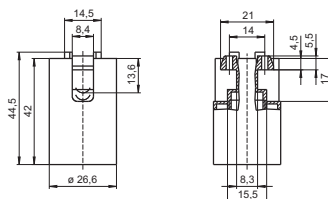

E14 lampholders, for cover caps

External thread 28x2 IEC 60399

Casing: PET GF, T210, nominal rating: 2/250

Push-in twin terminals: 0.5–1.5 mm²

Rear fixing holes for self-tapping screws

acc. to ISO 1481/7049-ST2.9-C/F

Weight: 12.5/12.2 g, unit: 1000 pcs.

Type: 64101

Ref. No.: 109387 white

Ref. No.: 109386 black

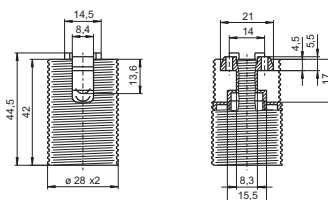

E14 lampholders, for cover caps

External thread 28x2 IEC 60399, with flange

Casing: PET GF, T210, nominal rating: 2/250

Push-in twin terminals: 0.5–1.5 mm²

Rear fixing holes for self-tapping screws

acc. to ISO 1481/7049-ST2.9-C/F

Weight: 12.7 g, unit: 1000 pcs.

Type: 64201

Ref. No.: 503924 white

Ref. No.: 503923 black

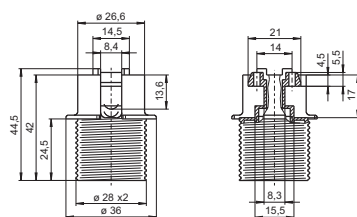

E14 lampholders, for cover caps

Profiled shape, short external thread 28x2 IEC 60399

Casing: PET GF, T210, Nominal rating: 2/250

Push-in twin terminals: 0.5–1.5 mm²

Rear fixing holes for self-tapping screws

acc. to ISO 1481/7049-ST2.9-C/F

Weight: 8.5/8.4 g, unit: 1000 pcs.

Type: 64370

Ref. No.: 546456 white

Ref. No.: 546454 black

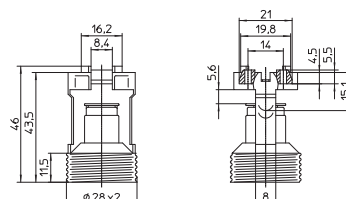

Lampholders for General-service Incandescent

E14 lampholders

Profiled shape, short external thread 28x2 IEC 60399

Casing: PET GF, T210, nominal rating: 2/250

Push-in twin terminals: 0.5-1.5 mm²

For clipping-in

Weight: 6.6/6.8 g, unit: 1000 pcs.

Type: 64360

Ref. No.: 506247 white

Ref. No.: 506249 black

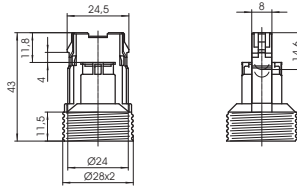

1

2

E14 lampholders

Profiled shape, nominal rating: 2/250

Push-in twin terminals: 0.5-1.5 mm²

Lateral push-fit foot for cut-out 10x20 mm

for wall thickness 0.6-1.3 mm

Tilt of lamp axis: 6°

For cover cap 503579

Weight: 9.1/9.2 g, unit: 1000 pcs.

Type: 64307

Ref. No.: 108983 PBT GF, white, T180

Ref. No.: 509263 PET GF, natural, T210

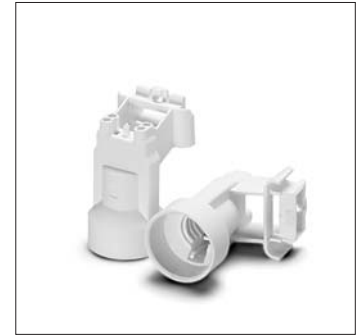
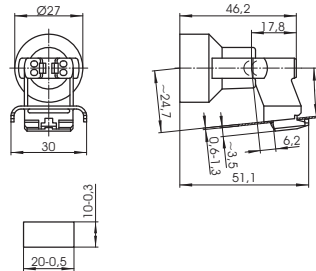

3

4

E14 lampholder

Profiled shape

Casing: PET GF, white, T210

Nominal rating: 2/250

Push-in twin terminals: 0.5-1.5 mm²

For insertion, clipping-in or bayonet fixing

for plastic cut-out: Ø 27.5 mm

with wall thickness: 2.5 mm

Weight: 7.1 g, unit: 1000 pcs.

Type: 64308

Ref. No.: 533820

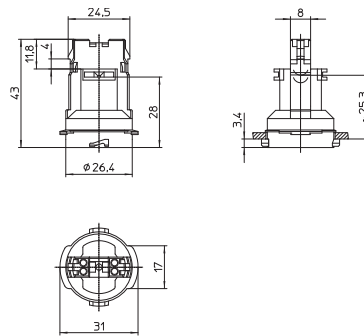

5

6

Cover Caps

For E14 thermoplastic lampholders, one-piece

Brass-finished versions are available on request.

Cover cap for lampholders type 64307

For luminaires of protection class II

Material: PP, white

Weight: 2.4 g, unit: 1000 pcs.

Type: 97322

Ref. No.: 503579

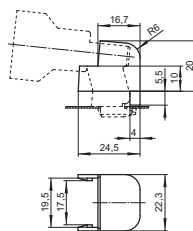

7

8

9

10

Lampholders for General-service Incandescent

Cover caps

Material: PA GF

Female nipple: M10x1

Weight: 7.6/8.8 g, unit: 1000 pcs.

Type: 85075

Ref. No.: 109110 white

Ref. No.: 109112 black

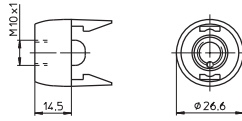

Cover caps

Material: PA GF

Moulded thread: M10x1

Rotation stop: external

Weight: 2.7 g, unit: 1000 pcs.

Type: 97636

Ref. No.: 109676 white

Ref. No.: 109677 black

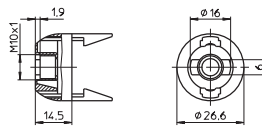

Cover caps

Material: PA GF

Moulded thread: M10x1

Rotation stop: external

With locking screw

Weight: 3 g, unit: 1000 pcs.

Type: 85076

Ref. No.: 400818 white

Ref. No.: 400817 black

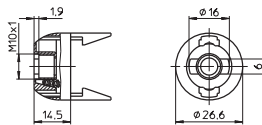

Cover caps

Height: 19 mm

Material: PA GF

Moulded thread: M10x1

Rotation stop: external

Weight: 3.2/3.1 g, unit: 1000 pcs.

Type: 97705

Ref. No.: 520733 white

Ref. No.: 520734 black

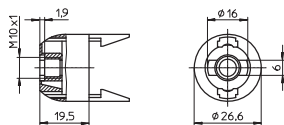

Cover caps

Height: 19 mm

Material: PA GF

Moulded thread: M10x1

Rotation stop: external

With locking screw

Weight: 3.6/3.5 g, unit: 1000 pcs.

Type: 85074

Ref. No.: 520735 white

Ref. No.: 520736 black

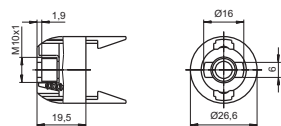

Lampholders for General-service Incandescent

Cover caps

Material: PA GF

Round hole: \varnothing 10.5 mm

Rotation stop: internal and external

Weight: 4.3 g, unit: 1000 pcs.

Type: 97666

Ref. No.: 109119 white

Ref. No.: 109120 black

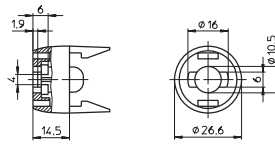

1

2

Cover caps

Material: PA GF

Profiled hole: \varnothing 10.5x8.6 mm

Fixing holes for screws M3

Weight: 4.4/4.3 g, unit: 1000 pcs.

Type: 97635

Ref. No.: 109122 white

Ref. No.: 109123 black

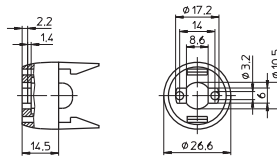

3

4

Cover cap

Material: PA GF

Profiled hole: \varnothing 10.4 mm

Rotation stop: internal and external

Weight: 4 g, unit: 1000 pcs.

Type: 97697

Ref. No.: 109126 black

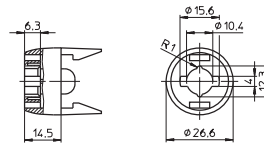

5

6

Cover caps

Height: 19 mm

Material: PA GF

Profiled hole: \varnothing 10.4 mm

Rotation stop: internal and external

Weight: 2.7 g, unit: 1000 pcs.

Type: 97708

Ref. No.: 520759 white

Ref. No.: 520760 black

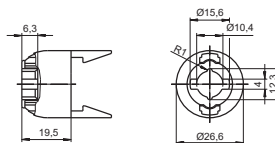

7

8

Cover caps

With peg

With integrated cord grip

For leads H03VWH2-F 2X0.75

Material: PA GF

Weight: 4.2/4.3 g, unit: 1000 pcs.

Type: 97000

Ref. No.: 503457 white

Ref. No.: 503458 black

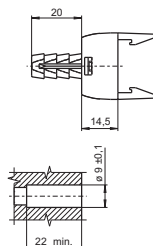

9

10

Lampholders for General-service Incandescent

Cover cap

With male nipple: M10x1
 With rotation stop
 With integrated cord grip
 For leads H03VVH2-F 2X0.75
 Material: PA GF, white
 Weight: 4.1 g, unit: 1000 pcs.
 Type: 97037

Ref. No.: 508067

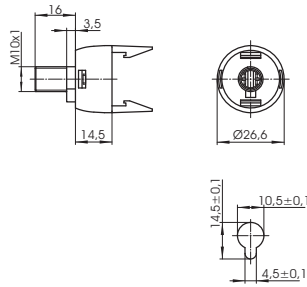

Cover cap

External thread 28x2 IEC 60399
 With integrated cord grip
 For leads H03VVH2-F 2X0.75
 Material: PA GF, natural
 Weight: 5.5 g, unit: 1000 pcs.
 Type: 97427

Ref. No.: 509340

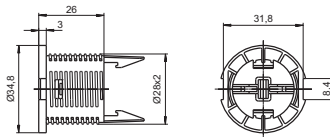

Cover cap

Lateral push-fit foot for cut-out 10x20 mm
 For luminaires of protection class II
 Material: PA GF, white
 Weight: 4.3 g, unit: 1000 pcs.
 Type: 97745

Ref. No.: 546006

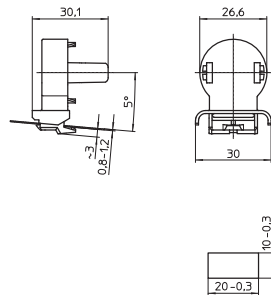

Cover cap

With central positioning stud
 Material: PA GF
 Fixing holes for countersunk screws \varnothing 3 mm
 Weight: 3 g, unit: 1000 pcs.
 Type: 91522

Ref. No.: 535357

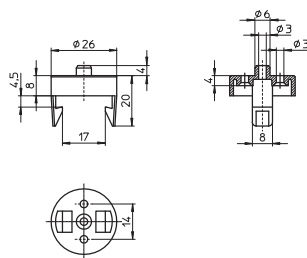

Table Lamp Set

For E14 lampholders, one-piece

For E14 lampholders type 64001 (s. p. 298)

For glass with hole: \varnothing 40-45 mm

Material: PA

Fixing insert for cover cap 534089

For glass with hole: \varnothing 40-45 mm,

wall thickness: 3-10 mm

Weight: 6.9 g, unit: 500 pcs.

Type: 97658

Ref. No.: 534087 natural

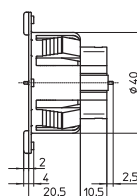
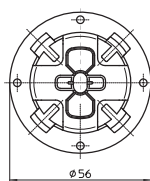

Screw ring for fixing insert

External thread 38x2.5

Weight: 3.4 g, unit: 500 pcs.

Type: 97701

Ref. No.: 534088 natural

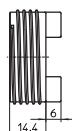
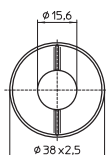

Cover cap for E14 lampholders

Suitable for fixing insert 534087

With cord grip for lead H03VH2-F

Weight: 3.4 g, unit: 1000 pcs.

Type: 97692

Ref. No.: 534089 white

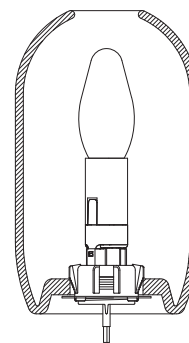
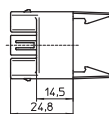

E14 Thermoplastic Lampholders, Three-piece

For incandescent lamps with base E14

Nominal rating: 2/250

Temperature marking: T190

Brass-finished versions are available on request.

Inserts

Material: PET GF, black

Casing lock

Weight: 3.9/3.2 g, unit: 1000 pcs.

Type: 81095 screw terminals: 0.5-2.5 mm²

Ref. No.: 103424

Type: 81096 push-in twin terminals: 0.5-1.5 mm²

Ref. No.: 107716



1

2

3

4

5

6

7

8

9

10

Lampholders for General-service Incandescent

Plain casings

Material: PET GF

Weight: 9/8.5 g, unit: 1000 pcs.

Type: 81093

Ref. No.: 103415 white

Ref. No.: 103414 black

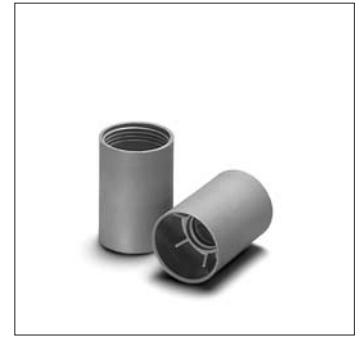
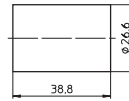

Threaded casings 28x2 IEC 60399

Material: PET GF

Weight: 9.8/9.6 g, unit: 1000 pcs.

Type: 81109

Ref. No.: 103431 white

Ref. No.: 103430 black

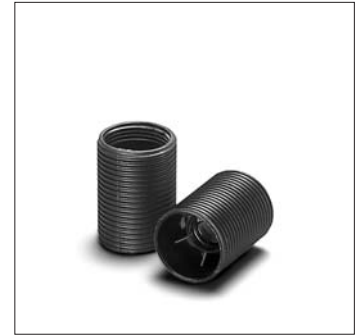
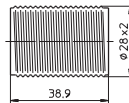

Threaded casings 28x2 IEC 60399

With flange

Material: PET GF

Weight: 10.6/10.4 g, unit: 1000 pcs.

Type: 81120

Ref. No.: 103443 white

Ref. No.: 103442 black

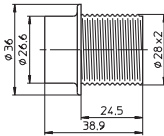

Caps

Material: PA GF

Female nipple: M10x1

Height: 13.7 mm

Weight: 6.9/7.2 g, unit: 1000 pcs.

Type: 81002

Ref. No.: 109102 white

Ref. No.: 109103 black

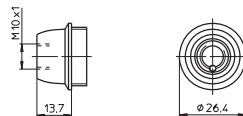

Caps

Material: PA GF

Female nipple: M10x1

Height: 18.7 mm

Weight: 7/7.3 g, unit: 1000 pcs.

Type: 81024

Ref. No.: 109805 white

Ref. No.: 109145 black

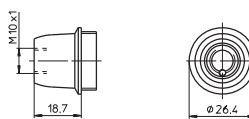

Lampholders for General-service Incandescent

Caps

Material: PA GF
 Moulded thread: M10x1
 Rotation stop: external
 Height: 13.7 mm
 Weight: 3.3/3.7 g, unit: 1000 pcs.
 Type: 96159

Ref. No.: 109095 white
Ref. No.: 109084 black

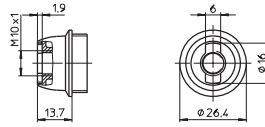

1

2

Caps

Material: PA GF
 Moulded thread: M10x1
 Rotation stop: external
 Height: 18.7 mm
 Weight: 3.6/3.9 g, unit: 1000 pcs.
 Type: 96211

Ref. No.: 109149 white
Ref. No.: 109150 black

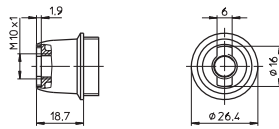

3

4

Caps

Material: PA GF
 Moulded thread: M10x1
 Rotation stop: external
 With locking screw
 Height: 13.7 mm
 Weight: 3.7/4 g, unit: 1000 pcs.
 Type: 81130

Ref. No.: 109041 white
Ref. No.: 109054 black

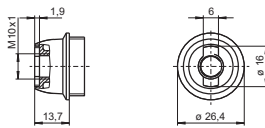

5

6

Caps

Material: PA GF
 Moulded thread: M10x1
 Rotation stop: external
 With locking screw
 Height: 18.7 mm
 Weight: 3.9/4.3 g, unit: 1000 pcs.
 Type: 81132

Ref. No.: 109152 white
Ref. No.: 109153 black

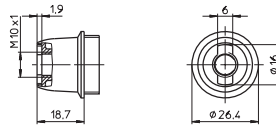

7

8

Caps

Material: PA GF
 Round hole: \varnothing 10.5 mm
 Rotation stop: internal
 Height: 13.7 mm
 Weight: 3.3 g, unit: 1000 pcs.
 Type: 96004

Ref. No.: 508352 white
Ref. No.: 508353 black

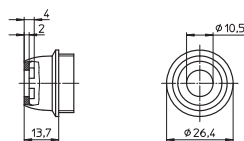

9

10

E14 Metal Lampholders, Three-piece

For incandescent lamps with base E14

Nominal rating: 2/250
 Temperature marking: T190/T240
 Type: 513 plain casing
 Type: 514 threaded casing 28x2

Insert

Material: porcelain, white
 Casing lock
 Screw terminals: 0.5-2.5 mm²
 Weight: 10.3 g, unit: 500 pcs.
 Type: 83142

Ref. No.: 550375



Plain casings

Material: zinc-coated polished steel
 Weight: 14.3/14.2/18.3/18.2 g
 Unit: 500 pcs.
 Type: 81019 insulating threaded ring: duroplastic, T190

Ref. No.: 103359 chrome-finish

Ref. No.: 103360 brass-finish

Type: 81018 insulating threaded ring: steatite, T240

Ref. No.: 507049 chrome-finish

Ref. No.: 507050 brass-finish

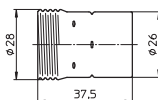

Threaded casings 28x2 IEC 60399

Material: zinc-coated polished steel
 Weight: 14.4/14.4/18.9/18.9 g
 Unit: 500 pcs.
 Type: 81022 insulating threaded ring: duroplastic, T190

Ref. No.: 103365 chrome-finish

Ref. No.: 103366 brass-finish

Type: 81017 insulating threaded ring: steatite, T240

Ref. No.: 507052 chrome-finish

Ref. No.: 507053 brass-finish

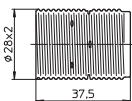

Caps

Material: zinc-coated polished steel
 Female nipple: M10x1
 Weight: 7.2/7.1/7.9/7.8 g
 Unit: 500 pcs.

Type: 80006

Ref. No.: 102946 chrome-finish

Ref. No.: 102947 brass-finish

Type: 80003 with earth terminal

Ref. No.: 102938 chrome-finish

Ref. No.: 102939 brass-finish

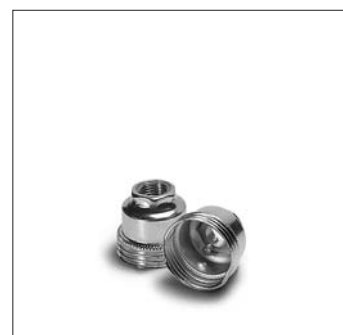
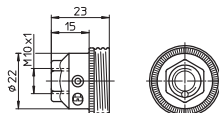
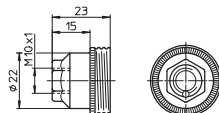

E14 Thermoplastic Rocker Switch Lampholders

For incandescent lamps with base E14

Nominal rating: 2/250
Temperature marking: T160

Suitable casings see page 304:
Type: 81093 plain casing
Type: 81109 threaded casing 28x2
Type: 81120 threaded casing 28x2, with flange

Inserts with switch
Material: PET GF
Screw terminals: 0.5-2.5 mm²
Weight: 7.9 g, unit: 1000 pcs.
Type: 83141

Ref. No.: 537087 switch, white
Ref. No.: 537088 switch, black

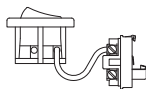

Caps
Material: PET GF
Moulded thread: M10x1
with locking screw
Weight: 9.9 g, unit: 1000 pcs.
Type: 81100

Ref. No.: 537079 white
Ref. No.: 537080 black

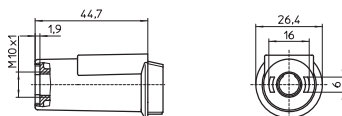

E27 Thermoplastic Lampholders, One-piece

For incandescent lamps with base E27

E27 lampholders with temperature marking
T180 on request.
Brass-finished versions are available on request.

E27 lampholders, for cover caps
Plain casing
Casing: PET GF, T210
Nominal rating: 4/250
Push-in twin terminals: 0.5-2.5 mm²
Fixing holes for screws M4
Weight: 17.4 g, unit: 500 pcs.
Type: 64401

Ref. No.: 108936 white
Ref. No.: 500810 black

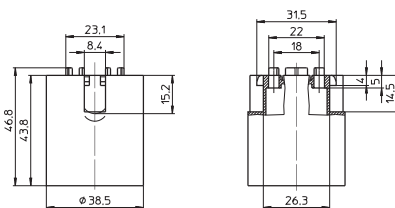

1



2

3

4



5

6

7

8



9

10

Lampholders for General-service Incandescent

E27 lampholders, for cover caps
 External thread 40x2.5 IEC 60399
 Casing: PET GF, T210
 Nominal rating: 4/250
 Push-in twin terminals: 0.5–2.5 mm²
 Fixing holes for screws M4
 Weight: 19.1/18.8 g, unit: 500 pcs.
 Type: 64501

Ref. No.: 108965 white
Ref. No.: 109429 black

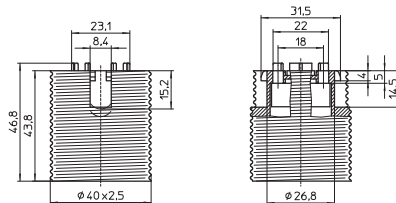

E27 lampholders, for cover caps
 External thread 40x2.5 IEC 60399, with flange
 Casing: PET GF, T210
 Nominal rating: 4/250
 Push-in twin terminals: 0.5–2.5 mm²
 Fixing holes for screws M4
 Weight: 21.4 g, unit: 500 pcs.
 Type: 64601

Ref. No.: 501358 white
Ref. No.: 501356 black

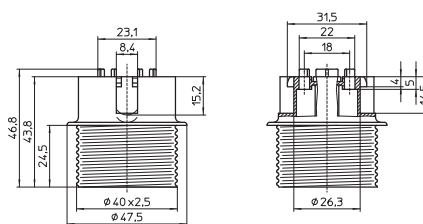

E27 lampholders, for cover caps
 Profiled shape, external thread 40x2.5 IEC 60399
 Casing: PET GF, T210, nominal rating: 4/250
 Push-in twin terminals: 0.5–2.5 mm²
 Fixing holes for screws M3
 Rear fixing holes for self-tapping screws
 acc. to ISO 1481/7049-ST3.9-C/F
 Weight: 14.8/14.9 g, unit: 500 pcs.
 Type: 64719

Ref. No.: 504303 white
Ref. No.: 504302 black

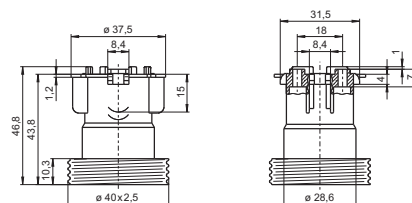

E27 lampholders, for cover caps
 Profiled shape, external thread 40x2.5 IEC 60399
 Casing: PET GF, T210, nominal rating: 4/250
 Push-in twin terminals: 0.5–2.5 mm²
 Fixing holes for screws M3
 Rear fixing holes for self-tapping screws
 acc. to ISO 1481/7049-ST3.9-C/F
 Weight: 11.4/11.3 g, unit: 500 pcs.
 Type: 64775

Ref. No.: 506255 white
Ref. No.: 506257 black

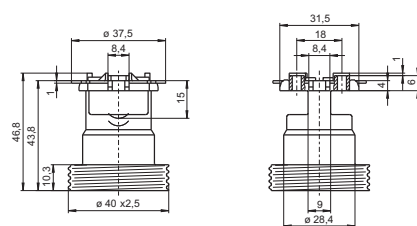

E27 lampholders
 Profiled shape, plain, nominal rating: 4/250
 Screw terminals: 0.5–2.5 mm²
 Fixing holes for screws M3
 Rear fixing holes for self-tapping screws
 acc. to ISO 1481/7049-ST3.9-C/F
 Weight: 11.7/11.5/13 g, unit: 500 pcs.
 Type: 64785

Ref. No.: 506263 PET GF, white, T210
Ref. No.: 506265 PET GF, black, T210
Ref. No.: 506267 LCP, natural, T270

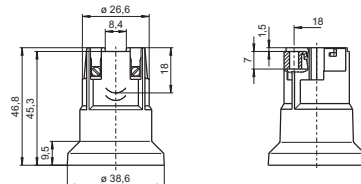

Lampholders for General-service Incandescent

E27 lampholders

For cover caps type 97545/80023 (see p. 311)

Profiled shape, plain, nominal rating: 4/250

Push-in twin terminals: 0.5–2.5 mm²

Fixing holes for screws M3

Rear fixing holes for self-tapping screws

acc. to ISO 1481/7049-ST3.9-C/F

Weight: 11.5/14.9 g, unit: 500 pcs.

Type: 64770

Ref. No.: 108953 PET GF, natural, T210

Ref. No.: 109838 LCP, natural, T270

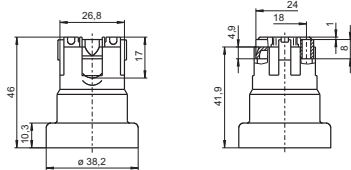

1

2

E27 lampholder

For luminaires of protection class II

Profiled shape, plain

Casing: PET GF, white, T210

Nominal rating: 4/250

Screw terminals: 0.5–2.5 mm²

Lateral fixing hole for screw M4

Tilt of lamp axis: 3°

Weight: 15.2 g, unit: 500 pcs.

Type: 64781

Ref. No.: 503041

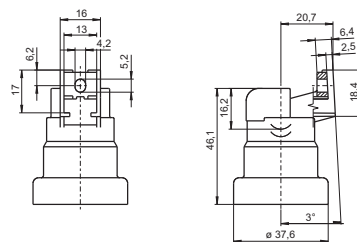

3

4

E27 lampholders

Profiled shape, plain

Casing: PET GF, T210

Nominal rating: 4/250

Push-in twin terminals: 0.5–2.5 mm²

Lateral fixing hole for screw M4

Tilt of lamp axis: 3°

Weight: 13.3 g, unit: 500 pcs.

Type: 64740

Ref. No.: 108747 white

Ref. No.: 529599 natural

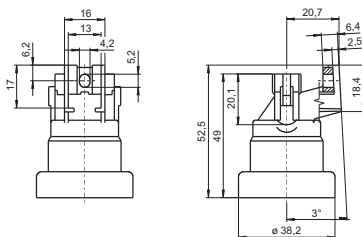

5

6

E27 lampholder

Profiled shape, external thread 40x2.5 IEC 60399

Casing: PET GF, natural, T210, nominal rating: 4/250

Push-in twin terminals: 0.5–2.5 mm²

Lateral push-fit foot for cut-out 10x20 mm

Fixing clips for wall thickness 0.4–1 mm

Tilt of lamp axis: 12°

For cover cap 504615 (see below)

Weight: 14.7 g, unit: 500 pcs.

Type: 64741

Ref. No.: 108758

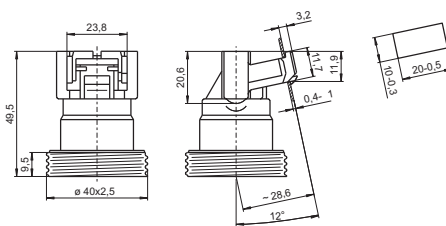

7

8

9

10

Cover Caps

For E27 thermoplastic lampholders, one-piece and for B22d thermoplastic lampholders

Cover cap for lampholder 108758 (see above)
 For luminaires of protection class II
 Material: PA GF, white
 Weight: 2.7 g, unit: 500 pcs.
 Type: 97321

Ref. No.: 504615

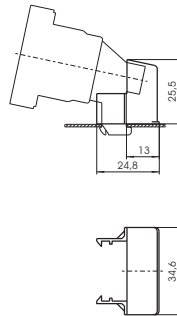

Protection caps for E27 lampholders with
 bracket with earth connection 400772 (s. p. 328)
 For lampholder type 64770/64785 (s. p. 328)
 For luminaires of protection class II
 Material: PA GF, natural
 Weight: 4.8 g, unit: 500 pcs.
 Type: 97497

Ref. No.: 526886

Type: 97498 fixing hole: \varnothing 10 mm

Ref. No.: 529464

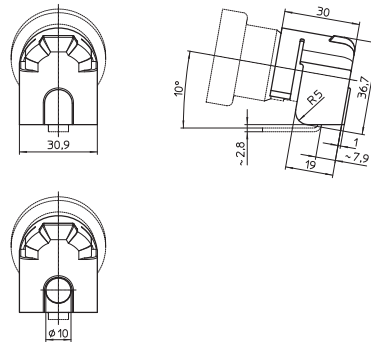

Cover caps

Material: PA GF

Female nipple: M10x1

Weight: 9.6/9.9 g, unit: 500 pcs.

Type: 85070

Ref. No.: 109077 white

Ref. No.: 109092 black

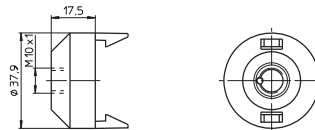

Cover caps

Material: PA GF

Moulded thread: M10x1

Cross groove for rotation stop: external

Weight: 4.4/4.6 g, unit: 500 pcs.

Type: 97665

Ref. No.: 109679 white

Ref. No.: 109680 black

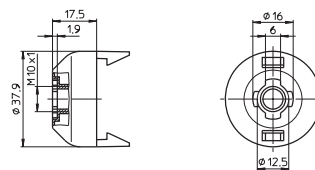

Lampholders for General-service Incandescent

Cover caps

Material: PA GF

Moulded thread: M10x1

Cross groove for rotation stop: external

With lateral hole

Weight: 4/4.6 g, unit: 500 pcs.

Type: 97664

Ref. No.: 109795 white

Ref. No.: 109794 black

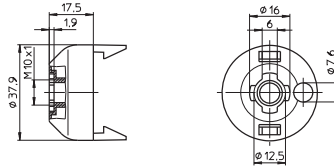

1

2

Cover caps

Material: PA GF

Moulded thread: M10x1

Cross groove for rotation stop: external

With locking screw

Weight: 4.7/4.9 g, unit: 500 pcs.

Type: 85077

Ref. No.: 400819 white

Ref. No.: 400820 black

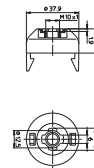

3

4

Cover caps

For E27 lampholders type 64770

Material: PA GF, black

Moulded thread: M10x1

Cross groove for rotation stop: external

Weight: 3.1/3.4 g, unit: 500 pcs.

Type: 97545

Ref. No.: 532390

Type: 80023 with locking screw

Ref. No.: 532391

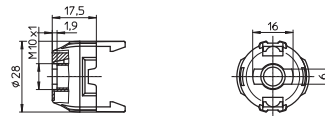

5

6

Cover caps

Material: PA GF

Profiled hole: Ø 10.4 mm

Rotation stop: internal and external

Weight: 5.7/5.9 g, unit: 500 pcs.

Type: 97698

Ref. No.: 109560 white

Ref. No.: 109184 black

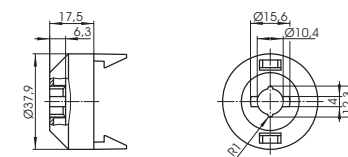

7

8

Cover caps

Material: PA GF

Round hole: Ø 10.5 mm

Rotation stop: external

Fixing holes for screws M4

Weight: 5.4/5.5 g, unit: 500 pcs.

Type: 97511

Ref. No.: 109045 white

Ref. No.: 109062 black

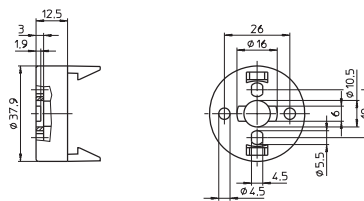

9

10

Lampholders for General-service Incandescent

Cover caps

Conical shape

Material: PA GF

Moulded thread: M10x1

Cross groove for rotation stop: external

Weight: 8.9/8.8 g, unit: 500 pcs.

Type: 97260

Ref. No.: 109555 white

Ref. No.: 109556 black

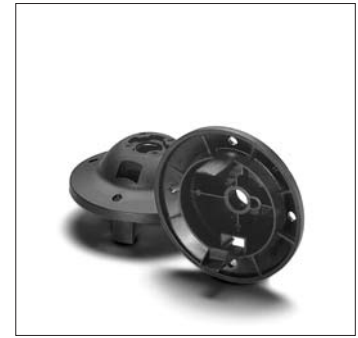
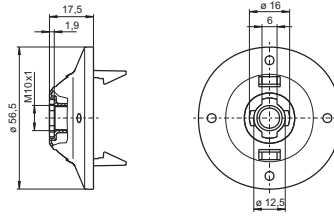

Cover caps

Conical shape

Material: PA GF

With integrated cord grip

For leads H03VV-F 2X0.5 or

H03VV-F 2X0.75

Weight: 10.6/10.5 g, unit: 500 pcs.

Type: 83282

Ref. No.: 109159 white

Ref. No.: 109462 black

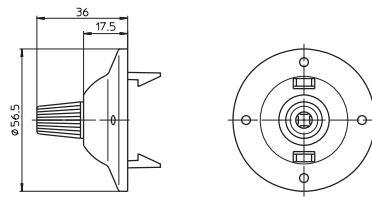

Cover cap for lampholder 102624 (see p. 318)

With cord grip for self-tapping screws

acc. to ISO 1481/7049-ST2.9-C/F

Cord grip for luminaires of protection class II

Material: PA GF, black

Weight: 12.5/2.2 g, unit: 500 pcs.

Type: 96206 cover cap

Ref. No.: 107178

Type: 96242 cord grip

Ref. No.: 107177

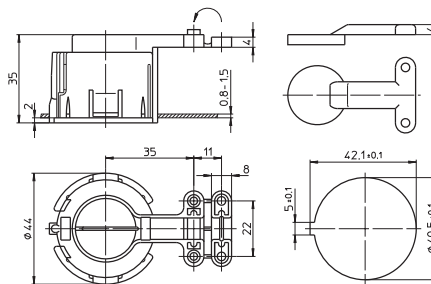

Cover caps

Material: PA GF

With integrated cord grip

For leads H03VV-F 2X0.5 or

H03VV-F 2X0.75

Weight: 6.6/5.8 g, unit: 500 pcs.

Type: 83283

Ref. No.: 504769 white

Ref. No.: 507075 black

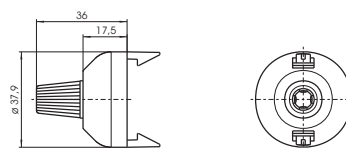

Table Lamp Set

For E27 lampholders, one-piece

For E27 lampholders type 64401 (s. p. 307)

For glass with hole: \varnothing 40-45 mm

Material: PA

Fixing insert for cover cap 534090

For glass with hole: \varnothing 40-45 mm,

wall thickness: 3-10 mm

Weight: 6.9 g, unit: 500 pcs.

Type: 97658

Ref. No.: 534087 natural

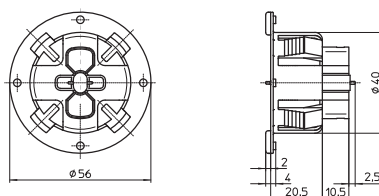

Screw ring for fixing insert

External thread 38x2.5

Weight: 3.4 g, unit: 500 pcs.

Type: 97701

Ref. No.: 534088 natural

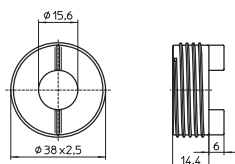

Cover cap for E27 lampholders

Suitable for fixing insert 534087

With cord grip for lead H03VH2-F

Weight: 5.4 g, unit: 500 pcs.

Type: 97700

Ref. No.: 534090 white

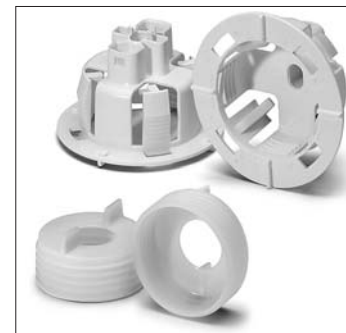
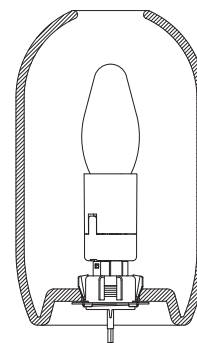
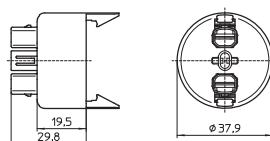

E27 Renovation Kit Lampholders

For incandescent lamps with base E27

E27 renovation kit lampholders with suspension

Profiled shaped lampholder 64770 - T180

Cover cap with cord grip 532394

Nominal rating: 4/250

Lead: Cu, stranded conductors 0.75 mm²,

double PVC-insulation, length: 150 mm

Weight: 25.8/26.2 g, unit: 150 pcs.

Type: 64770

Ref. No.: 547393 black, with screw terminal

Ref. No.: 547394 black, with push-in terminal

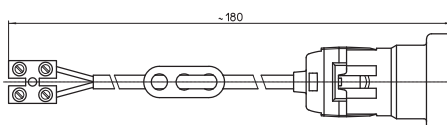

1

2

3

4

5

6

7

8

9

10

E27 Thermoplastic Lampholders, Three-piece

For incandescent lamps with base E27

Nominal rating: 4/250

Temperature marking: T190

Brass-finished versions are available on request.

Inserts

Material: PET GF, black

Casing lock

Weight: 5.7/6.1 g, unit: 500 pcs.

Type: 83285 push-in terminals: 0.5-1.5 mm²

Ref. No.: 103643

Type: 83013 push-in twin terminals: 0.5-2.5 mm²

Ref. No.: 546004

Type: 83011 screw terminals: 0.5-2.5 mm²

Ref. No.: 103520

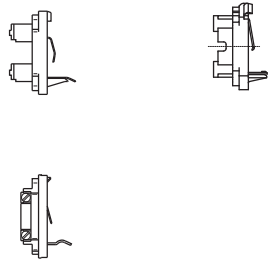

Plain casings

Material: PET GF

Weight: 14.5/14.3 g, unit: 500 pcs.

Type: 83000

Ref. No.: 103468 white

Ref. No.: 103467 black

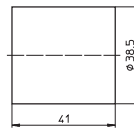

Threaded casings 40x2.5 IEC 60399

Material: PET GF

Weight: 17/16.1 g, unit: 500 pcs.

Type: 83002

Ref. No.: 103484 white

Ref. No.: 103483 black

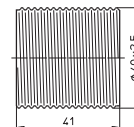

Threaded casings 40x2.5 IEC 60399

With flange

Material: PET GF

Weight: 16.7/17 g, unit: 500 pcs.

Type: 83173

Ref. No.: 103570 white

Ref. No.: 103569 black

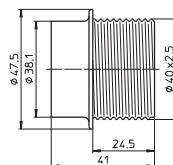

Lampholders for General-service Incandescent

Caps

Material: PA GF
 Profiled hole: $\varnothing 10.5 \times 8.6$ mm
 Fixing holes for screws M4
 Height: 13.8 mm
 Weight: 5.6/6 g, unit: 500 pcs.
 Type: 96148

Ref. No.: 109188 white
Ref. No.: 109187 black

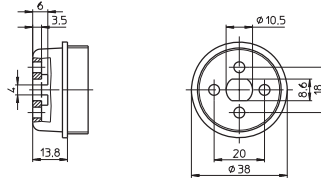

1

2

Caps

Material: PA GF
 Female nipple: M10x1
 Height: 17 mm
 Weight: 9.8/10.1 g, unit: 500 pcs.
 Type: 83007

Ref. No.: 109052 white
Ref. No.: 109039 black

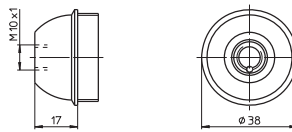

3

4

Caps with earth terminal

Material: PA GF
 Female nipple: M10x1
 Height: 17 mm
 Weight: 10.7/11 g, unit: 500 pcs.
 Type: 83035

Ref. No.: 109098 white
Ref. No.: 109099 black

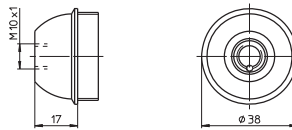

5

6

Caps

Material: PA GF
 Moulded thread: M10x1
 Rotation stop: external
 Height: 17 mm
 Weight: 6.7/7 g, unit: 500 pcs.
 Type: 96147

Ref. No.: 109195 white
Ref. No.: 109196 black

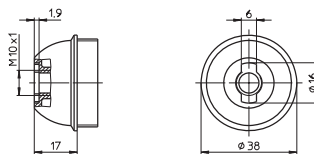

7

8

Caps

Material: PA GF
 Moulded thread: M10x1
 Rotation stop: external
 With locking screw
 Height: 17 mm
 Weight: 7.1/7.3 g, unit: 500 pcs.
 Type: 83293

Ref. No.: 109087 white
Ref. No.: 109074 black

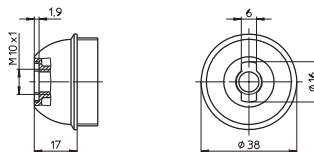

9

10

Lampholders for General-service Incandescent

Caps

Material: PA GF

Round hole: \varnothing 10.5 mm

Rotation stop: internal and external

Height: 17 mm

Weight: 5.9/6.6 g, unit: 500 pcs.

Type: 96154

Ref. No.: 109190 white

Ref. No.: 109191 black

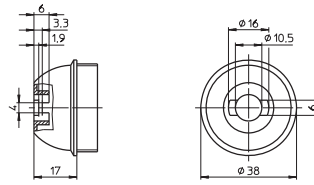

Caps

Material: PA GF

Profiled hole: \varnothing 10.3 mm

Rotation stop: internal and external

Height: 17 mm

Weight: 5.9/6.6 g, unit: 500 pcs.

Type: 96124

Ref. No.: 109559 white

Ref. No.: 109512 black

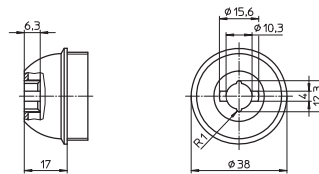

Caps

Conical shape

Material: PA GF

Female nipple: M10x1

Height: 19.2 mm

Weight: 14.2/15.2 g, unit: 500 pcs.

Type: 83274

Ref. No.: 109081 white

Ref. No.: 109093 black

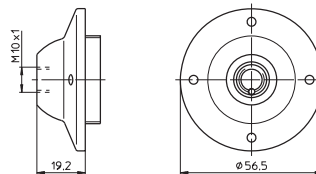

Caps

Conical shape

Material: PA GF

Round hole: \varnothing 10.5 mm

Rotation stop: internal

Height: 19.2 mm

Weight: 10.4/10.6 g, unit: 500 pcs.

Type: 96172

Ref. No.: 109060 white

Ref. No.: 109044 black

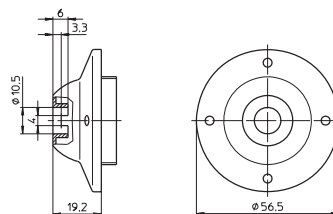

E27 Porcelain Lampholders

For incandescent lamps with base E27

E27 lampholders, one-piece
 Material: porcelain, white, T270
 Nominal rating: 4/250/5 kV
 Screw terminals: 0.5-2.5 mm²
 Spring loaded central contact
 Fixing oblong holes for screws M4
 Weight: 60.6 g, unit: 250 pcs.
 Type: 62050

Ref. No.: 102599

Type: 62010 with lamp safety catch (with spring)

Ref. No.: 102577

Type: 62009 with lamp safety catch (with crushing)

Ref. No.: 544605

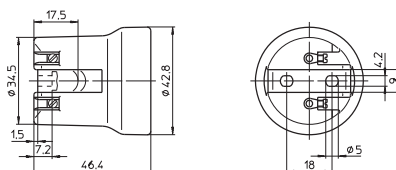

E27 lampholder, one-piece
 Material: porcelain, white, T270
 Nominal rating: 4/250/5 kV
 Screw terminals: 0.5-2.5 mm²
 Spring loaded central contact
 Fixing pillars for screws M3
 Weight: 66.3 g, unit: 250 pcs.
 Type: 62015

Ref. No.: 102582

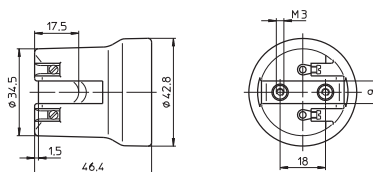

E27 lampholder, one-piece
 Material: porcelain, white, T270
 Nominal rating: 4/250/5 kV
 Screw terminals: 0.5-2.5 mm²
 Spring loaded central contact
 Fixing oblong holes for screws M4
 Weight: 60.5 g, unit: 200 pcs.
 Type: 62070

Ref. No.: 543304

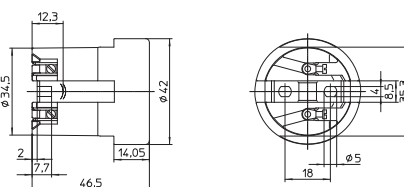

E27 lampholder, one-piece
 Material: porcelain, white, T270
 Nominal rating: 4/250/5 kV
 Screw terminals: 0.5-2.5 mm²
 With lateral fixing flange,
 tilt angle: 15°
 Spring loaded central contact
 Fixing hole for screw M4
 Weight: 67.6 g, unit: 200 pcs.
 Type: 62415

Ref. No.: 543414

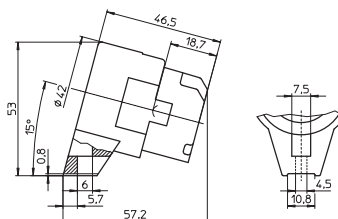

1

2

3

4

5

6

7

8

9

10

Lampholders for General-service Incandescent

E27 lampholder, one-piece, for cover caps (see p. 310-312)

Material: porcelain, white, T270
 Nominal rating: 4/250/5 kV
 Screw terminals: 0.5-2.5 mm²
 Spring loaded central contact
 Fixing oblong holes for screws M4
 Weight: 66.5 g, unit: 250 pcs.
 Type: 62310

Ref. No.: 102624

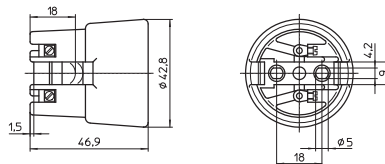

E27 lampholder

For cover caps type 80010, 97735 and 97742 (see below)

Material: porcelain, white, T270
 Nominal rating: 4/250/5 kV
 Screw terminals: 0.5-2.5 mm²
 Spring loaded central contact
 Fixing holes for screw M4
 Weight: 66.5 g, unit: 250 pcs.
 Type: 62370

Ref. No.: 543303

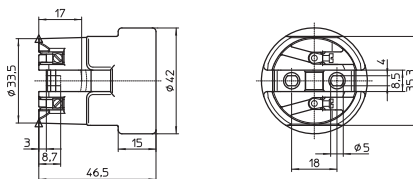

Cover caps for lampholder 543303

Material: PA GF
 Weight: 12.5/12.5/10/10 g, unit: 500 pcs.
 Type: 97735 moulded thread: M10x1, without locking screw

Ref. No.: 536445 black

Ref. No.: 536446 white

Type: 97742 moulded thread: M10x1, with lateral hole, without locking screw

Ref. No.: 535247 black

Type: 80010 female nipple: G3/8A

Ref. No.: 535694 white

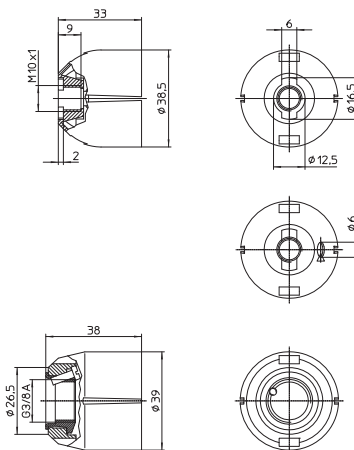

E27 lampholder, three-piece

Material: porcelain, white, T240, nominal rating: 4/250, screw terminals: 0.5-2.5 mm²
 Weight: 116/125/116/125/121.7/130.7 g
 Unit: 25 pcs.

Type: 62061 female nipple: M10x1

Ref. No.: 535684

Ref. No.: 535685 with earth screw

Type: 62062 female nipple: M13x1

Ref. No.: 536451

Ref. No.: 536452 with earth screw

Type: 62063 female nipple: G3/8A

Ref. No.: 534832

Ref. No.: 534833 with earth screw

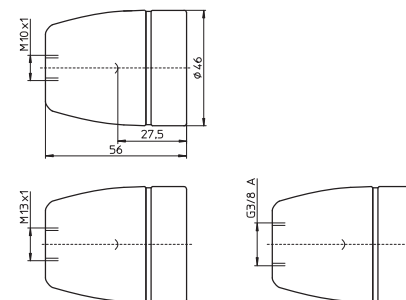

E27 Metal Lampholders, Three-piece

For incandescent lamps with base E27

Nominal rating: 4/250
 Type: 670 plain casing
 Type: 671 threaded casing 40x2.5
 Temperature marking: T240

Inserts

Material: porcelain, white
 Screw terminals: 0.5-2.5 mm²
 Spring loaded central contact, casing lock
 Weight: 22.8/23.3 g, unit: 500 pcs.
 Type: 83221

Ref. No.: 103595

Type: 83223 with earth terminal

Ref. No.: 103597

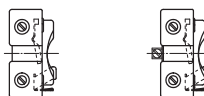

Plain casings

Material: zinc-coated polished steel
 Weight: 23.5/22.9/27.1/27.1 g
 Unit: 500 pcs.
 Type: 83218 insulating threaded ring: PPS
Ref. No.: 103582 chrome-finish
Ref. No.: 103583 brass-finish
 Type: 83226 insulating threaded ring: steatite
Ref. No.: 504640 chrome-finish
Ref. No.: 504641 brass-finish

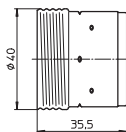

Threaded casings 40x2.5 IEC 60399

Material: zinc-coated polished steel
 Weight: 24/23.1/27.3/27.6 g
 Unit: 500 pcs.
 Type: 83219 insulating threaded ring: PPS
Ref. No.: 103590 chrome-finish
Ref. No.: 103591 brass-finish
 Type: 83227 insulating threaded ring: steatite
Ref. No.: 504643 chrome-finish
Ref. No.: 504644 brass-finish

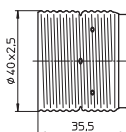

Caps

Material: zinc-coated polished steel
 Female nipple: M10x1
 Weight: 10.6/10.8/11.4/11.3 g
 Unit: 500 pcs.
 Type: 80342
Ref. No.: 103020 chrome-finish
Ref. No.: 103021 brass-finish
 Type: 80343 with earth terminal
Ref. No.: 103026 chrome-finish
Ref. No.: 103027 brass-finish

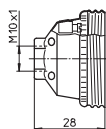
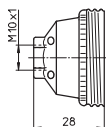

1

2

3

4

5

6

7

8

9

10

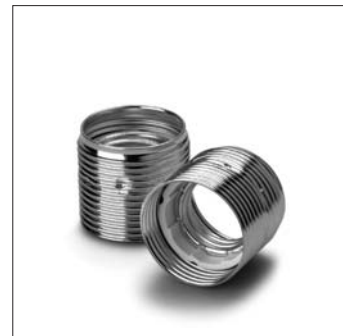

E27 Thermoplastic Pull-switch Lampholders

For incandescent lamps with base E27

Nominal rating: 2/250

Type: 65300 plain casing, with pull cord

Type: 65308 plain casing, with draw chain

Type: 65400 threaded casing 40x2.5, with pull cord

Type: 65408 threaded casing 40x2.5, with draw chain

Insert with pull cord

Material: PET GF, black

Screw terminals: 0.5-2.5 mm²

Length of cord: 250 mm

Weight: 12.3 g, unit: 500 pcs.

Type: 83146

Ref. No.: 507802

End button for pull cord, material: PS, white

Weight: 0.8 g, unit: 500 pcs.

Type: 96010

Ref. No.: 105144

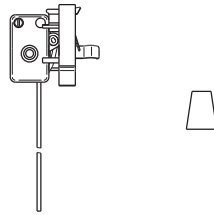

Insert for brass chain

Material: PET GF, black

Screw terminals: 0.5-2.5 mm²

Weight: 11.7 g, unit: 500 pcs.

Type: 83147

Ref. No.: 507803

Draw chain with end button

Material: brass, length of chain: 85 mm

Weight: 3.9 g, unit: 500 pcs.

Type: 94304

Ref. No.: 104928

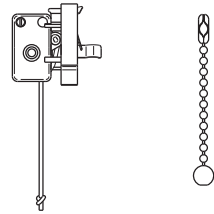

Plain casings

Material: PET GF

Weight: 11.7 g, unit: 500 pcs.

Type: 96033

Ref. No.: 105179 white

Ref. No.: 109280 black

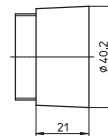

Threaded casings 40x2.5 IEC 60399

Material: PET GF

Weight: 9.3 g, unit: 500 pcs.

Type: 96034

Ref. No.: 105185 white

Ref. No.: 109281 black

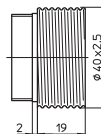

Lampholders for General-service Incandescent

Caps

Material: PET GF

Female nipple: M10x1

Weight: 19.8/19.4 g, unit: 500 pcs.

Type: 83258

Ref. No.: 109282 white

Ref. No.: 109283 black

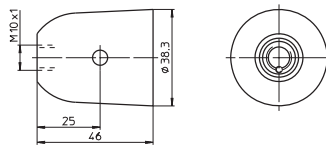

1

2

Flange rings

For pull-switch lampholders type 654

Material: PA GF

Ø 60 mm, height: 6.5 mm

Weight: 3/3.1 g, unit: 500 pcs.

Type: 08400

Ref. No.: 501351 white

Ref. No.: 501352 black

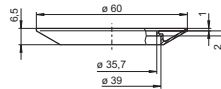

3

4

E27 Metal Pull-switch Lampholders

For incandescent lamps with base E27

Nominal rating: 2/250

Type: 55204 plain casing, with pull cord

Type: 55203 plain casing, with draw chain

Type: 55304 threaded casing 40x2.5, with pull cord

Type: 55303 threaded casing 40x2.5, with draw chain



5

6

Insert with pull cord

Material: porcelain, white

Screw terminals: 0.5-2.5 mm²

Length of cord: 250 mm, casing lock

Weight: 28 g, unit: 500 pcs.

Type: 83006

Ref. No.: 103504

End button for pull cord, material: PS, white

Weight: 0.8 g, unit: 500 pcs.

Type: 96010

Ref. No.: 105144

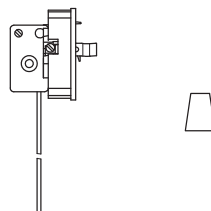

7

8

Insert for brass chain

Material: porcelain, white

Screw terminals: 0.5-2.5 mm²

Weight: 29.4 g, unit: 500 pcs.

Type: 83008

Ref. No.: 103515

Draw chain with end button

Material: brass, length of chain: 85 mm

Weight: 3.9 g, unit: 500 pcs.

Type: 94304

Ref. No.: 104928

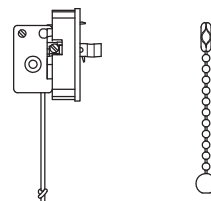

9

10

Lampholders for General-service Incandescent

Casings

Material: brass, passivated
 Insulating threaded ring: PPS
 Weight: 21.5/22.7 g, unit: 500 pcs.
 Type: 83218 plain casing

Ref. No.: 103587

Type: 83219 threaded casing 40x2.5

Ref. No.: 103594

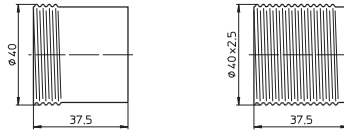

Cap with earth terminal

Material: brass, passivated
 Female nipple: M10x1
 With insulating insert
 Weight: 20 g, unit: 500 pcs.
 Type: 80014

Ref. No.: 102956

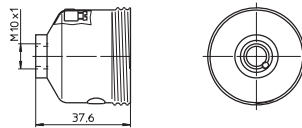

E27 Thermoplastic Rocker Switch Lampholders

For incandescent lamps with base E27

Nominal rating: 2/250
 Temperature marking: T180
 Suitable casings see page 318:
 Type: 83000 plain casing
 Type: 83002 threaded casing 40x2.5
 Type: 83173 threaded casing 40x2.5, with flange

Inserts with switch

Material: PET GF, white
 Screw terminals: 0.5-2.5 mm²
 Weight: 11/11.1 g, unit: 500 pcs.
 Type: 83015

Ref. No.: 107331 switch, white

Ref. No.: 107096 switch, black

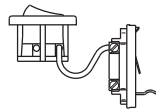

Caps

Material: PA GF
 Female nipple: M10x1
 Weight: 14.2/14.7 g, unit: 500 pcs.
 Type: 83260

Ref. No.: 109198 white

Ref. No.: 109199 black

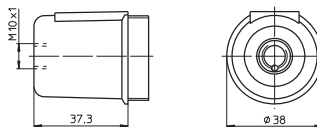

Lampholders for General-service Incandescent

Caps

Material: PA GF

Profiled hole: \varnothing 10.4 mm

Rotation stop: internal and external

Weight: 8.2/10.4 g, unit: 500 pcs.

Type: 96229

Ref. No.: 109200 white

Ref. No.: 109201 black

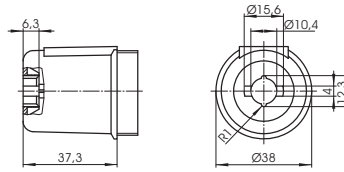

1

2

3

4

5

E27 Festoon Lampholders

For lighting chains of protection class II

Degree of protection: IP44

Type: 64710/11

The lampholders may only be operated with the lamp pointing downwards and with a gasket.

E27 festoon lampholder

For lamps max. 40 W

Material: PBT GF, black

Nominal rating: 4/250

Blade contacts

for festoon lead H05RN H2-F 2X1.5

To be used only with protection cap

Weight: 13.8 g, unit: 500 pcs.

Type: 83297

Ref. No.: 109158

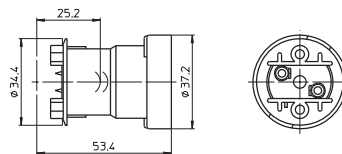

6

7

8

Protection cap

For E27 festoon lampholders

Material: PA GF, black

With ready-fitted stainless screws

Weight: 6.3 g, unit: 500 pcs.

Type: 83300 with non-removable screws

Ref. No.: 109243

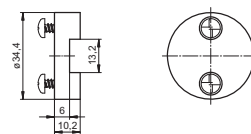

9

10

Lampholders for General-service Incandescent

Protection cap

For E27 festoon lampholders

Material: PA GF, black

With ready-fitted stainless screws

Fixing holes for screws M4

Weight: 7.2 g, unit: 500 pcs.

Type: 83301 with non-removable screws

Ref. No.: 502515

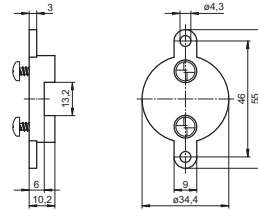

Gasket

For E27 festoon lampholders

Material: silicone

Weight: 4 g, unit: 500 pcs.

Type: 98006

Ref. No.: 106817

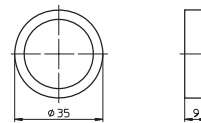

B22d Lampholders, Accessories

For mains voltage halogen incandescent lamps

B22d lampholders

For cover caps (see p. 310–312)

Nominal rating: 2/250

Push-in twin terminals: 0.5–1.5 mm²

Fixing holes for self-tapping screws

acc. to ISO 1481/7049-ST3.9-C/F

Weight: 12.7/12.3 g, unit: 500 pcs.

Type: 64800

Ref. No.: 108748 PET GF, T180, white

Ref. No.: 544621 PET GF, T210, white

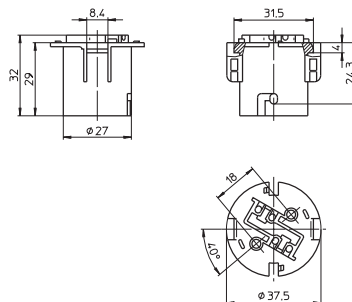

Plain casing

For B22d lampholders type 64800

For cover caps (see p. 310–312)

Threaded casing on request

Material: PA GF, white

Weight: 14.5 g, unit: 500 pcs.

Type: 96021

Ref. No.: 504749

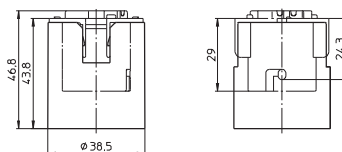

Lampholders for General-service Incandescent

B22d lampholder

With protection flange

For cover caps type 80010, 97735 and 97742 (see below)

Casing: porcelain, white, T240

Nominal rating: 2/250

Screw terminals: 0.5-2.5 mm²

Fixing holes for screws M3

Weight: 84.7 g, unit: 150 pcs.

Type: 64900

Ref. No.: 535673

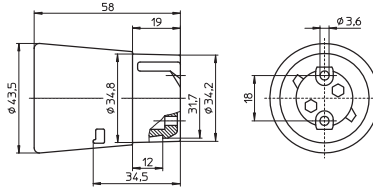

1

2

B22d lampholder

Casing: porcelain, white, T240

Nominal rating: 2/250

Screw terminals: 0.5-2.5 mm²

Lateral fixing bracket

Tilt angle: 15°

Fixing hole for screws M4

Weight: 70 g, unit: 150 pcs.

Type: 64940

Ref. No.: 535674

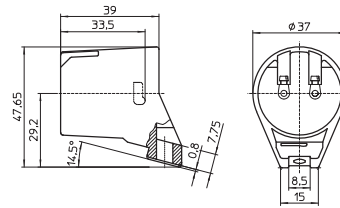

3

4

Cover caps for lampholder 535673

Material: PA GF

Weight: 12.5/12.5/10/10 g, unit: 500 pcs.

Type: 97735 moulded thread: M10x1, without locking screw

Ref. No.: 536445 black

Ref. No.: 536446 white

Type: 97742 moulded thread: M10x1, with lateral hole, without locking screw

Ref. No.: 535247 black

Type: 80010 female nipple: G3/8A

Ref. No.: 535694 white

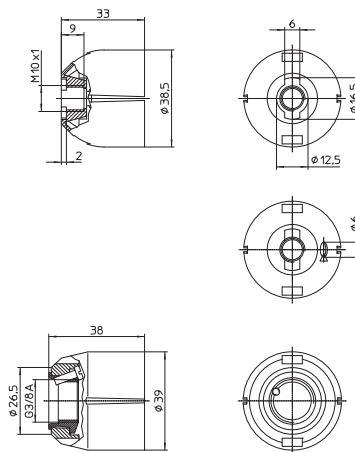

5

6

7

8

9

10

Accessories

For E14, E27 lampholders, one-piece and three-piece and B22d lampholders

The luminaire manufacturer is responsible for the right choice of accessories.
Brass-finished versions are available on request.

Plastic screw rings

For E14 lampholders
with external thread 28x2 IEC 60399
Weight: 3.6/3.2/1.8/1.6 g, unit: 1000 pcs.
Type: 03210 Ø 43 mm, height: 15 mm

Ref. No.: 100125 PET GF, white

Ref. No.: 109162 PA GF, black

Type: 05202 Ø 34 mm, height: 7.5 mm

Ref. No.: 107154 PET GF, white

Ref. No.: 109166 PA GF, black

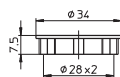
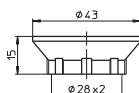

Metal screw ring

For E14 lampholders
with external thread 28x2 IEC 60399
Material: zinc-coated polished steel, chrome-finish
Ø 40 mm, height: 12 mm
Weight: 4.3 g, unit: 500 pcs.
Type: 06700

Ref. No.: 100194

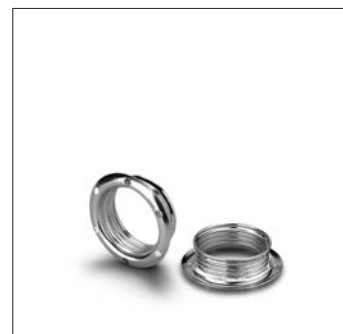
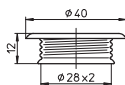

Front gasket

For E14 lampholders type 64305, 64306, 64308, 64313, 64316, 64360, 64380 and 64381

As lamp safety catch and for protection against moisture acc. to IEC 60079-15

Material: elastomer

Weight: 1.1 g, unit: 2000 pcs.

Type: 98013

Ref. No.: 534689



Plastic screw rings

For E27 and B22d lampholders
Weight: 4.9/4.4/3.3/3 g, unit: 500 pcs.
Type: 08610 Ø 55 mm, height: 15 mm

Ref. No.: 100270 PET GF, white

Ref. No.: 109285 PA GF, black

Type: 08701 Ø 47.8 mm, height: 9 mm

Ref. No.: 100273 PET GF, white

Ref. No.: 109291 PA GF, black

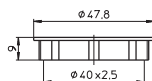
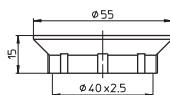

Lampholders for General-service Incandescent

Metal screw ring

For E27 and B22d lampholders

Material: zinc-coated polished steel, chrome-finish

Ø 56.5 mm, height: 13 mm

Weight: 7 g, unit: 500 pcs.

Type: 07400

Ref. No.: 100217

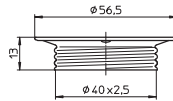

1

Brackets for E14 lampholders

For fastening with nipples 109249, 109247

Material: zinc-coated polished steel

Fixing holes for screws M3

Weight: 5.5/5.3/5.3 g, unit: 1000 pcs.

Type: 94068 internal bracket 90°

Ref. No.: 106767

Type: 94066 external bracket 90°

Ref. No.: 400671

Type: 94069 internal bracket 110°

Ref. No.: 106768

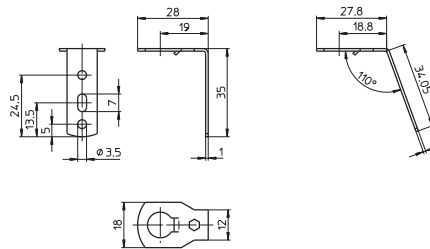

2

3

4

Bracket 90° for E14 lampholders

For fastening with nipples 109249, 109247

Material: zinc-coated polished steel

Fixing holes for screws M3

Weight: 6.2/8.5/8.5 g, unit: 1000 pcs.

Type: 94074 external bracket 18.5x33 mm

Ref. No.: 106802 holes diagonal

Type: 94067 external bracket 24x41.5 mm

Ref. No.: 106766 holes vertical

Type: 94079 internal bracket 24x41.5 mm

Ref. No.: 506211 holes vertical

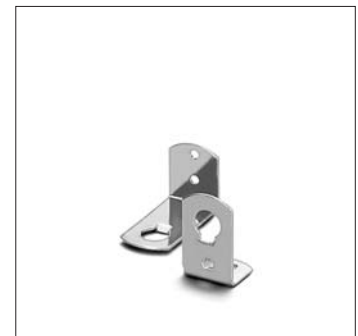
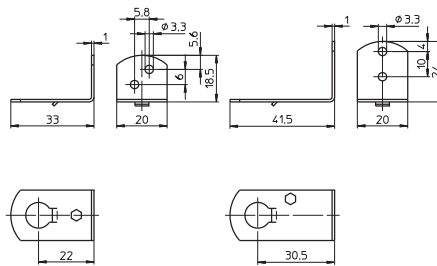

5

6

U-shaped clips

For E27 lampholders, one-piece

Material: zinc-coated polished steel, chrome-finish

For wall thickness: 0.5-2 mm

Weight: 3.7/4.3 g, unit: 2500 pcs.

Type: 94435

Ref. No.: 109621

Type: 80433 with earth terminal

Ref. No.: 103087

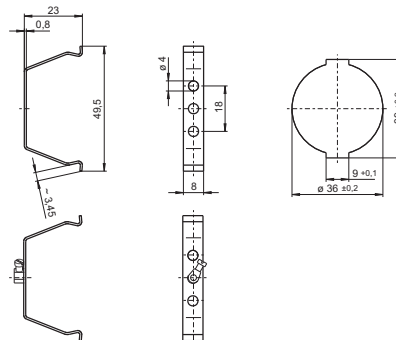

7

8

Base clips

For E14 and E27 lampholders, one-piece

Material: zinc-coated polished steel, chrome-finish

For wall thickness: 0.8-1.5 mm

Weight: 3.3/4 g, unit: 2500 pcs.

Type: 94436

Ref. No.: 109622

Type: 80474 with earth terminal

(without drawing)

Ref. No.: 400699

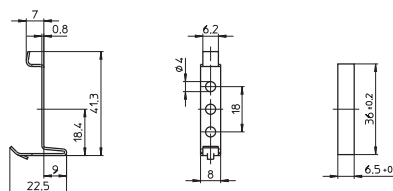

9

10

Lampholders for General-service Incandescent

Brackets: 90°, 12.5x47.1 mm

For E14 and E27 lampholders, one-piece

Material: zinc-coated polished steel, chrome-finish

Fixing hole for screw M5

Weight: 5.6/4.8 g, unit: 500 pcs.

Type: 80475 with earth terminal

Ref. No.: 400779

Type: 94444

Ref. No.: 401536

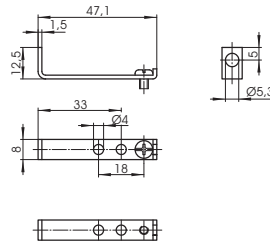

Brackets: 100°, 22.9x36.6 mm

For E14 and E27 lampholders, one-piece

Material: zinc-coated polished steel, chrome-finish

Fixing holes for self-tapping screws

acc. to ISO 1481/7049-ST2.9-C/F

Tapped hole M4

Weight: 5.5/4.6 g, unit: 1000 pcs.

Type: 80476 with earth terminal

Ref. No.: 400772

Type: 94438

Ref. No.: 401549

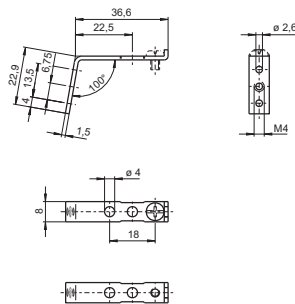

Fixing bracket

For E14 and E27 lampholders, one-piece

Material: zinc-coated polished steel, chrome-finish

With slots for screws M4

Weight: 4.6 g, unit: 1000 pcs.

Type: 94450

Ref. No.: 106829

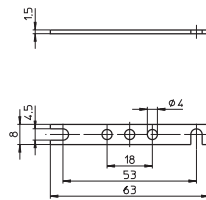

Fixing bracket: 8°

For E27 thermoplastic lampholders

type 64719 (see p. 307) and for B22d

thermoplastic lampholders type 648 (see p. 324)

For clicking-on onto the lampholder

Material: PA, white

Oblong hole for screw M4

Weight: 1.9 g, unit: 500 pcs.

Type: 97194

Ref. No.: 108956

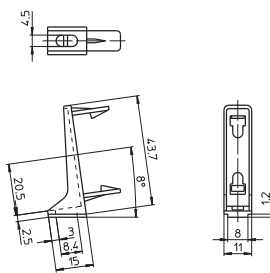

Fixing brackets: 8°, 14.5x39 mm

For E27 thermoplastic lampholders, one-piece

Material: PET GF, white

With cable holder

Oblong hole for screw M4

Weight: 3/3.6 g, unit: 1000 pcs.

Type: 97750 fixing holes: Ø 4 mm

Ref. No.: 109725

Type: 97752 fixing holes for self-tapping screws acc. to ISO 1481/7049-ST3.9-C/F

Ref. No.: 109728

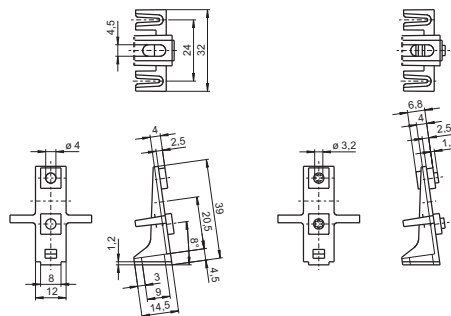

Lampholders for General-service Incandescent

Fixing brackets: 8°, 14.4x39 mm

For E27 thermoplastic lampholders, one-piece

Material: PET GF, white

Oblong hole for screw M4

Weight: 1.9/4.3 g, unit: 1000 pcs.

Type: 97159 fixing holes: Ø 4 mm

Ref. No.: 108304

Type: 97755 fixing holes for self-tapping screws acc. to ISO 1481/7049-ST3.9-C/F

Ref. No.: 400732

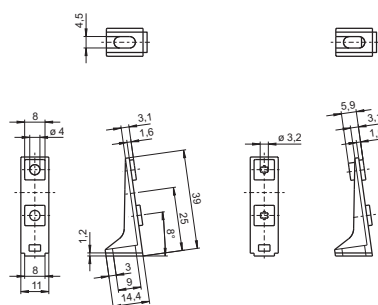

1

2

Fixing bracket: 8°, 20x44.4 mm

For E27 thermoplastic lampholders, one-piece

Material: PET GF, white

Fixing holes: Ø 4 mm

With cable holder

Oblong hole for screw M4

Weight: 3.7 g, unit: 1000 pcs.

Type: 97754

Ref. No.: 401970

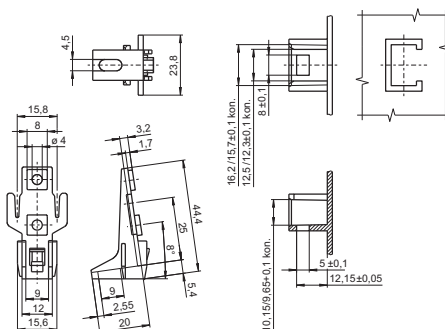

3

4

Nipples

For E14 cover caps with moulded thread: M10x1

Cross groove for rotation stop: external

For E27 caps (see p. 315-316), for fastening of brackets 106766 and 106802 (see p. 327)

Material: PA, white

Male nipple: M10x1, with hexagon flange

Weight: 0.5 g, unit: 1000 pcs.

Type: 09700/09703/09708

Ref. No.: 538089 length: 15 mm

Ref. No.: 109249 length: 10 mm

Ref. No.: 109247 length: 7 mm

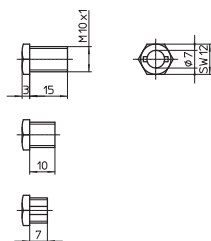

5

6

Locking nut for thread M10x1

Material: PA GF

Weight: 0.9 g, unit: 1000 pcs.

Type: 97267

Ref. No.: 507797 white

Ref. No.: 507798 black



7

8

Cord grip with insulating socket

For E14 and E27 lampholders

Material: PA, natural

For luminaires of protection class II

For leads H03VVH2-F 2X0.75

Weight: 0.6 g, unit: 1000 pcs.

Type: 97632

Ref. No.: 534097

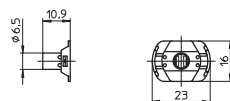

9

10

Lampholders for General-service Incandescent

Cable grips

For leads: H03VV-F

Material: PA

Male nipple: M10x1, length: 10 mm

With locking screw

Weight: 0.6 g, unit: 1000 pcs.

Type: 09701

Ref. No.: 543640 white

Ref. No.: 543641 black

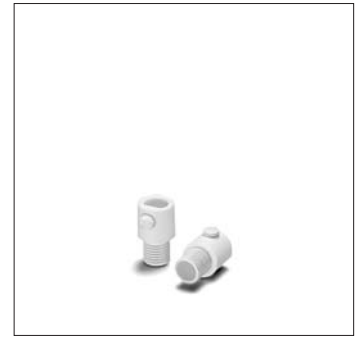
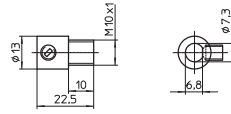

Cable grips

For leads H03VV-F and H03VVH2-F 2X0.5 or 2X0.75

Material: PA

Male nipple: M10x1, length: 11 mm

With locking screw

Weight: 1.6/1.5 g, unit: 1000 pcs.

Type: 09701

Ref. No.: 109248 white

Ref. No.: 109253 black

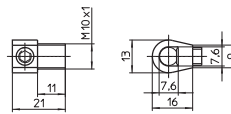

Cord grip

For E14 lampholders, three-piece, with cap height: 19 mm

For leads H03VVH2-F

Material: PA, transparent

Weight: 0.6 g, unit: 1000 pcs.

Type: 09501

Ref. No.: 106948



Cord grip

For E27 lampholders, three-piece (without switch)

For leads H03VVH2-F

Weight: 0.9 g, unit: 1000 pcs.

Type: 09502

Ref. No.: 106949 PA, transparent

Insulating socket

Material: PA, transparent

Weight: 0.5 g, unit: 1000 pcs.

Type: 09705

Ref. No.: 109592

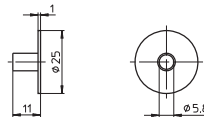

Cord grips

For leads H03VV-F 2X0.5 or H03VV-F 2X0.75

Material: PA

Weight: 0.9/0.8/1.7/1.6 g, unit: 1000 pcs.

Type: 09606 cord grips

Ref. No.: 506026 white

Ref. No.: 506027 black

Type: 96160 screw caps

Ref. No.: 109318 white

Ref. No.: 109317 black



Lampholders for General-service Incandescent

Cord grips

For leads H03VV-F 2X0.5 or

H03VV-F 2X0.75

Material: PA, male nipple: M10x1

Weight: 1/0.9/1.7/1.6 g, unit: 1000 pcs.

Type: 09607 cord grips

Ref. No.: 506024 white

Ref. No.: 506020 black

Type: 96160 screw caps

Ref. No.: 109318 white

Ref. No.: 109317 black

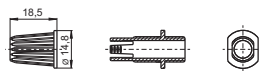

1

2

Insulating socket for E14 lampholders

Material: PA, transparent

Weight: 1 g, unit: 1000 pcs.

Type: 09704

Ref. No.: 109600

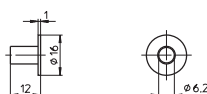

3

4

5

6

7

8

9

10

E40 Porcelain Lampholders

For incandescent lamps with base E40

Nominal rating: 18/500/5 kV

Screw terminals: 1.5–4 mm²

Spring loaded central contact

E40 lampholders

Material: porcelain, white, T270

Oblong holes for screws M5

Weight: 224/229.3/224/229.3 g

Unit: 48 pcs.

Type: 12800/12801

Ref. No.: 108208

Ref. No.: 107780 with lamp safety catch

With steel thread

Ref. No.: 532602

Ref. No.: 532603 with lamp safety catch

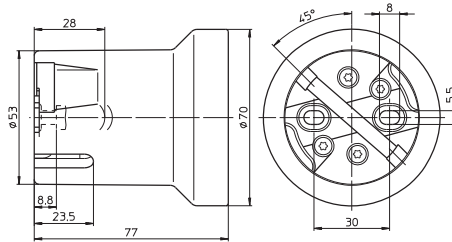

E40 lampholders

Material: porcelain, white, T270

Fixing bracket with slots for screws M5

Weight: 252.3/243/252.3/243 g

Unit: 48 pcs.

Type: 12810/12811

Ref. No.: 108374

Ref. No.: 108375 with lamp safety catch

With steel thread

Ref. No.: 532604

Ref. No.: 532605 with lamp safety catch

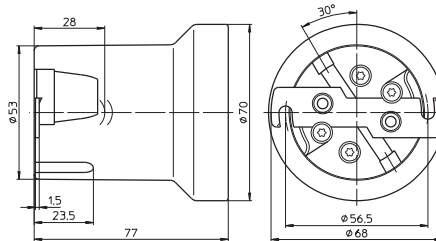

E40 lampholders

Material: porcelain, white, T270

Fixing bracket with tapped holes for screws M5

With lamp safety catch

Weight: 252.8 g, unit: 48 pcs.

Type: 12812

Ref. No.: 108373

With steel thread

Ref. No.: 532606

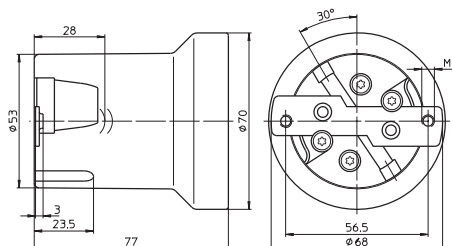

5

Components for Incandescent

Transformers and converters for low-voltage halogen lamps	334
Dimmability of VS transformers and VS converters	335
Electronic converters	335-339
Assembly instructions - Electronic converters	336-339
Electromagnetic transformers	340-344
Assembly instructions - Electromagnetic transformers	341-343
Conductors for low-voltage halogen installations	343-344
Lampholders for incandescent lamps	344-345
Retrofit Lamps	345
General technical details	366-374
Glossary	375-377

1

2

3

4

5

6

7

8

9

10

Transformers and converters for low-voltage halogen lamps

Operating low-voltage halogen lamps depends on operating devices that transform the usual mains voltage of 230 V to under 24 V. Safety transformers, of either electromagnetic or electronic (converter) design, have been in almost exclusive use for several years now. The type plate of electromagnetic transformers bears the symbol for safety transformers in accordance with VDE 0570, corresponding to EN 61558. Electronic converters are marked with the sign for Safety Extra-Low Voltage (SELV), which indicates that the product is an isolating converter whose secondary output is safe to touch even during no-load operation.

All Vossloh-Schwabe transformers are safety transformers, i.e. isolation transformers for supplying SELV (safety extra-low voltage) and PELV (protection extra-low voltage) circuits. With such systems, the voltage must not exceed a value of 50 V AC or 120 V DC (smoothed) between the conductors or a conductor and the earth conductor of a circuit that is separated from the mains by a safety transformer. The specified values apply for protected (non-touchable) voltages; 25 V AC and 60 V DC (smoothed) apply for exposed (touchable) voltages.

Depending on their design features to protect against touchable live parts, transformers and converters fall into one of two protection classes. Operating devices of protection class I are base-insulated and have a protective earth conductor connection terminal that must be connected to the protective earth conductor for safety reasons. Isolating transformers and converters of protection class II are equipped with double or reinforced insulation that protects against dangerous casing currents; these operating devices are solely available as independent operating devices (also see page 371; Protection Classes of Luminaires and Operating Devices).

Electronic converters can also be fitted with a functional earth terminal that must be connected to a functional earth to ensure compliance with EMC requirements. In addition, some electronic converters are designed in such a way that neither a protective earth conductor nor a functional earth needs to be connected.

Operating devices can also be differentiated according to the way they are used. Built-in transformers have to be installed in a permanent casing, e.g. a luminaire. In contrast, so-called independent transformers and converters can be operated independently of a luminaire. These are often found in ceiling installations; in order to prevent possible noise development, isolation transformers must be mounted in such a way as to avoid vibration transmission.

Transformers or converters bearing the MM mark can be mounted on surfaces of unknown flammability, which can be the case when mounting these devices on wooden furniture elements. Such devices comply with the temperature requirements of VDE 0710, part 14, of < 95 °C during normal and < 115 °C during abnormal operation.

Converters are labelled with a t_c point. The stipulated temperature (e.g. 75 °C) must not be exceeded when installed so that the service life of the converter is not shortened. The temperature quoted in the triangle (e.g. 110) denotes that the surface of the converter must never (even in the event of a defect) exceed this temperature.

Protection symbols



Safety transformer

SELV

Safety Extra Low Voltage



Protection class II



Independent operating device



Furniture installation
Normal operation < 95 °C
Abnormal operation < 115 °C

If the maximum value of 130 °C is not exceeded, the luminaire does not have to be tested in accordance with ∇ conditions.



$t_c = 75 \text{ °C}$
Measuring point for maximum permissible casing temperature



Temperature-protected converter
(in this case < 110 °C)

Dimmability of VS transformers and VS converters

Electromagnetic VS transformers can be controlled using phase-cutting leading-edge dimmers. These dimmers "cut" the sinusoidal mains voltage in the negative and positive half wave at an angle in the ascending portion of this sinusoidal half wave. The higher the angle is set at the dimmer controls, the lower the effective value of the voltage and hence the lamp's output.

Electronic VS converters can be controlled using phase-cutting trailing-edge dimmers. In this case, a semiconductor ensures the predefined descending portion of the sinusoidal half wave is clipped, i.e. the voltage is reduced in reverse mode. Again, higher the angle is set at the dimmer controls, the lower the effective value of the voltage and hence the lamp's output.

Converters of the LiteLine (EST 70/12.380, EST 105/12.381, EST 150/12.622 and EST 60/12.635) families can be operated using conventional phase-cutting trailing-edge and phase-cutting leading-edge dimmers.

Electronic Converters

The safe operation of electronic converters is dependent on the maximum permissible temperature not being exceeded at the measuring point. Vossloh-Schwabe has determined a casing temperature measuring point - $t_{c \text{ max.}}$ - on all converter casings. To avoid shortening the service life or diminishing operating safety, the stipulated maximum temperature must not be exceeded at this t_c point. This point is determined by testing the converter during normal, IEC-standardised operation at the specified max. ambient temperature (t_a), which is also indicated on the type plate. As both the design-related ambient temperature and the converter's inherent heat generation, as determined by the installed load, are subject to great variation, the casing temperature should be tested at the converter's t_c point under real installation conditions.

Temperature-protected converters feature a further protection symbol, namely a triangle containing the maximum temperature. This symbol certifies that the stipulated surface temperature of the device casing will not be exceeded during any operating state or in the event of a defect.

Vossloh-Schwabe electronic converters are tested in accordance with EN 61347. Function tests are carried out in accordance with EN 61047. VS converters can be operated without causing any inadmissible system reactions as all devices comply with EN 61000-3-2 on the limitation of mains harmonics. They also meet the EMC requirements of EN 61547. These devices are thus also protected against mains surges (as defined in the standard) that can be caused by, for instance, inductive ballasts during combined operation of fluorescent and low-voltage halogen lamps.

In addition, all devices comply with the RFI requirements of EN 55015. As the highly effective integrated filter can only limit the unit's own interference, the secondary conductor should be kept to under 2 metres in length so as to avoid RFI interference in the lighting system.

Dimmable using phase-cutting leading-edge or trailing-edge dimmers



Dimmable using phase-cutting leading-edge dimmers



Dimmable using phase-cutting trailing-edge dimmers



Working principle of a phase-cutting leading-edge dimmer

α = Ignition angle
 λ = Operating angle
 U = Voltage
 I = Current

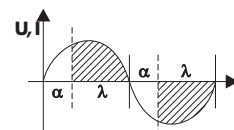

Working principle of a phase-cutting trailing-edge dimmer

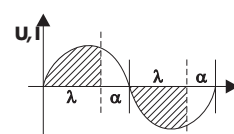

1

2

3

4

5

6

7

8

9

10

Assembly Instruction for Electronic Converters

For mounting and installing electronic converters for low-voltage halogen lamps

Mandatory regulations

DIN VDE 0100	Erection of low voltage installations
EN 60598-1	Luminaires – part 1: general requirements and tests
EN 61000-3-2	Electromagnetic compatibility (EMC) – part 3: maximum values – main section part 2: maximum values for mains harmonics (device input current up to and including 16 A per conductor)
EN 55015	Maximum values and methods of measurement for RFI suppression in electrical lighting installations and similar electrical appliances
EN 61547	Installations for general lighting purposes – EMC immunity requirements
EN 61347-1	Operating devices for lamps – part 1: general and safety requirements
EN 61347-2-2	Operating devices for lamps – part 2-2: special requirements for DC- or AC-powered electronic converters for incandescent lamps
EN 61047	DC- or AC-powered electronic converters for incandescent lamps – performance requirements

Designations for VS converters

Designations for electronic converters are first listed by the name of the product family, which in each case reflects the visible product properties. The type designation should be read as follows:

EST	60	/12	.388
Electronic safety transformer	Max. wattage	Lamp voltage	Serial number

Mechanical mounting

Mounting position Any

Clearance Min. of 0.1 m from walls, ceilings, insulation; min. of 0.1 m from other electronic converters; min. of 0.25 m from sources of heat (lamp)

Surface Solid; device must not be allowed to sink into insulation materials

Mounting location

In dry rooms or in luminaires, cases, casings or similar in the instance of built-in converters

Fastening Independent converters: using screws, Ø 4 mm
Built-in converters: fix M8 nut on the threaded stud

Heat transfer If the electronic converter is destined for installation in a luminaire, sufficient heat transfer must be ensured between the converter and the luminaire casing. During operation, the t_c point must not exceed the specified value.

Technical specifications

Type		Operating voltage range AC	Dimmability		Temperature protection	Through-wiring ³	Type of automatic cut-out and number of possible VS devices			
			Unsuitable for DC operation	Phasecutting trailing edge ¹			Phasecutting leading edge ¹	Electronic control ²	Converter quantity	B (10A)
LiteLine	EST 70/12.380	230-240	x	x	x	–	28	45	28	45
	EST 105/12.381	230-240	x	x	x	–	20	32	20	32
	EST 150/12.622	230-240	x	x	x	–	14	23	14	23
...Mini	EST 60/12.635	220-240	x	x	x	–	35	56	35	56

- ¹ The dimmer is connected to the primary side between mains and converter.
It is possible to connect several converters to one dimmer (whereby the dimmer's minimum and maximum load must be observed).
The dimmer-converter system should be subjected to function and noise development tests prior to installation.
- ² The rating is decreased electronically in the event of overheating.
- ³ Distributed secondary leads are only permitted on non-metallic surfaces (RFI suppression)

Properties of electronic converters

- Overheating** Protection against overheating is provided by an electronic controller (see table above).
- Short-circuit** The converter will be electronically disconnected in the event of a short-circuit at the output; once the short-circuit has been eliminated, the converter will switch on again automatically.
- Overload** Minor overloads (< 50%) will trigger the temperature switch against overheating; major overloads (> 50%) will trigger the same reaction as for short-circuit.

Should any of the above-mentioned safety functions be triggered, disconnect the converter from the power supply, then find and eliminate the cause of the problem.

- Protection against transient mains peaks**
Values compliant with EN 61547 (immunity)

1

2

3

4

5

6

7



8

9

10

Electrical installation

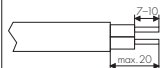
Conductors Primary conductor cross-section: min. 0.75 mm²
 Secondary conductor cross-section: min. 0,75 mm² for 50 W output and
 min. 1 mm² for 100 W output

Stripping		
Converter	60/12.635	70/12.380, 105/12.381, 150/12.622
Type of lead	All usual types of lead up to 4 mm ²	H03-VVH2-F 2X0.75 H05-VVH2-F 2X0.75 H03-VV-F 2X0.75 H05-VV-F 2X0.75
Lead preparation		

Connections Screw terminals: max. initial torque of 0.4 Nm must not be exceeded

Secondary length Min. 0.25 m (clearance to lamp), max. 2 m (RFI protection)

Secondary wiring Min. 0.1 m clearance from the mains (RFI protection)

Star wiring Twist single-wire or lead wires narrowly; silicone-insulated leads are recommended

Parallel connection
 Secondary-side parallel connection is inadmissible

Feed-through of the mains voltage
 See table on page 337
 Distributed secondary leads are only permitted on non-metallic surfaces (RFI suppression)

Selection of automatic cut-outs for VS converters

Dimensioning automatic cut-outs
 High transient mains current pulses occur when a converter is switched on because the capacitor has to load. As the lamps ignite almost simultaneously, this also creates a high power drain. The high currents that occur when the system is switched on put a strain on the automatic conductor cut-outs, which must be selected and dimensioned to suit.

Release reaction Release reaction of automatic cut-outs in accordance with VDE 0641, Part 11; for B and C characteristics. The values provided in the table on page 337 are meant as guidelines only and may vary depending on the respective lighting system.

No. of converters The maximum number of VS converters (see table on page 337) applies to cases where the devices are switched on simultaneously. Specifications apply to single-pole fuses. The number of permissible ballasts must be reduced by 20% for multi-pole fuses. The considered circuit impedance equals 400 mΩ (approx. 20 m [2.5 mm²] of conductor from the power supply to the distributor and a further 15 m to the luminaire).

Dimmability of electronic converters

Dimmed operation
 VS converters can be operated with phase-cutting trailing-edge dimmers. Some converters can additionally be operated with phase-cutting leading-edge dimmers (see table on page 337). The dimmer is connected to the primary side between mains and converter. It is possible to connect several converters to one dimmer (whereby the dimmer's minimum and maximum load must be observed). The dimmer-converter system should be subjected to function and noise development tests prior to installation.

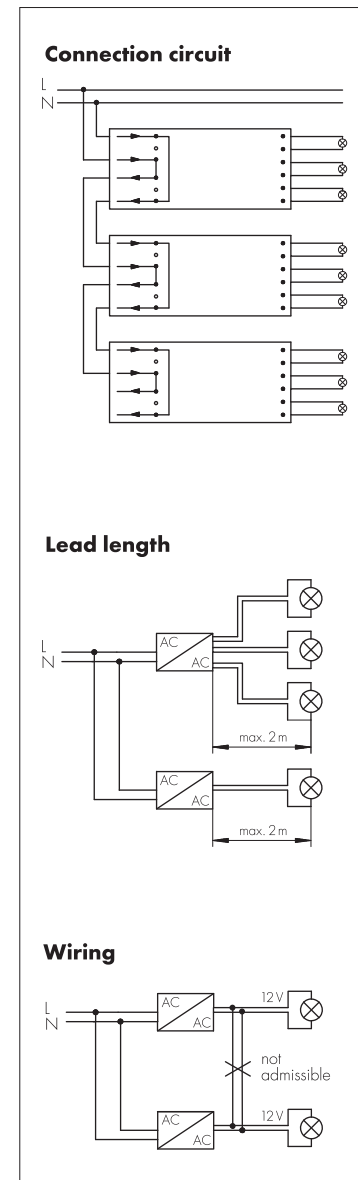

Electromagnetic compatibility (EMC)

Mains Harmonics

Maximum values are observed in accordance with EN 61000-3-2.

Interference

The requirements of EN 55015 must be met for luminaires with converters for operating low-voltage halogen lamps.

Vossloh-Schwabe converters are designed and manufactured to ensure these requirements are satisfied provided the installation instructions regarding the interference voltage at the connection terminals and electromagnetic interference fields up to 300 MHz are observed.

Additional information

Wiring

To ensure good radio interference suppression and the greatest possible operating safety, the following points should be observed when installing electronic converters:

- Conductors between the EST and the lamp (HF conductors) must be kept short (reduction of electromagnetic interference).
- Mains and lamp conductors must be kept separate and if possible should not be laid in parallel to one another. The distance between HF conductors and mains conductors should be as large as possible, ideally > 5 cm. (This prevents the induction of interference between the mains and lamp conductors).
- The mains conductor within the luminaire must be kept short (to reduce the induction of interference).
- The mains conductor must not be laid too close to the EST (this is especially important in the event of through-wiring).
- Mains and lamp conductors must not be crossed. Should this be impossible to avoid, conductors should be crossed at right angles to one another (to avoid inducing interference between mains and HF conductors).
- Should conductors be wired through metal parts, such conductors must always be additionally shielded (e.g. with an insulating sleeve or grommet).

Temperature

Reference point temperature t_c

The safe operation of electronic converters is dependent on the maximum permissible temperature not being exceeded at the measuring point. Vossloh-Schwabe has determined a casing temperature measuring point – $t_{c \max}$ – on all converter casings. To avoid shortening the service life or diminishing operating safety, the stipulated maximum temperature must not be exceeded at this t_c point. This point is determined by testing the converter during normal, IEC-standardised operation at the specified ambient temperature (t_a), which is also indicated on the type plate. As both the design-related ambient temperature and the converter's inherent heat, as determined by the installed load, are subject to great variation, the casing temperature should be tested at the t_c point under real installation conditions.

Ambient temperature t_a

The ambient temperature – as specified on every converter – denotes the permissible temperature range within the luminaire or at the place of installation.

Reliability

Service life of 50,000 hrs at reference point temperature t_c , whereby a switching cycle of 165 minutes on and 15 minutes off is assumed. Failure rate: $\leq 0.2\%/1,000$ hrs

In order to achieve the average service life, the maximum temperature ($t_{c \max}$) must not be exceeded at the t_c point.

Emergency lighting

VS electronic converters cannot be used for emergency lighting purposes as they are unsuitable for DC voltage operation.

1

2

3

4

5

6

7

8

9

10

Electromagnetic Transformers

Owing to the low internal impedance of electromagnetic transformers, high currents can occur in the event of a short-circuit on the secondary side, which can lead to the transformer being destroyed. For this reason, IEC 61558-1 differentiates between three types of transformer:

Transformers without short-circuit resistance

These transformers require external protection to prevent excessive temperatures being generated.

At Vossloh-Schwabe, these transformers are marked with the symbol "not short-circuit proof safety transformer". To protect against current overload during overload or short-circuit operation, Vossloh-Schwabe recommends installing a fuse on the primary side. As an aid to the user, the rating of this fuse is stated on the type plate in accordance with IEC 60127. The installed primary-side fuse should be easily accessible so that it can be readily replaced at any time.

Transformers with (limited) short-circuit resistance

These transformers feature a safety device that prevents excessive temperatures being generated.

Electromagnetic transformers with thermal cut-outs afford a limited degree of short-circuit resistance and do not need to be additionally fused. VS safety transformers of limited short-circuit resistance are designed to safely cut out in the event of overload or short-circuit, but not to restart automatically after cooling off. The transformer must first be disconnected from the mains (i.e. switched off and on) before it can be restarted. The thermal cut-outs are dimensioned to ensure that the maximum permissible winding temperature of 225°C (transformers of thermal class B) or 240°C (F) or 260°C (H) is not exceeded in the event of overload or short-circuit.

Transformers with (unlimited) short-circuit resistance

These transformers are designed to ensure that fixed maximum temperatures are not exceeded in the event of overload or short-circuit.

This type of safety transformer is not in common use within the lighting industry due to the relatively large dimensions it needs to meet the overload and short-circuit requirements.

All transformers will function perfectly and meet the requirements of the standard after the overload or short-circuit has been eliminated.

In addition to the above, there are also so-called **failsafe transformers** that are rendered permanently inoperative in the event of improper use, but do not pose a threat to the user or the surroundings. Vossloh-Schwabe does not provide this type of isolation transformer.

All Vossloh-Schwabe transformers are tested for compliance with the safety requirements of European standard EN 61558 regarding creepage and air clearance distances, the winding temperature and the maximum permissible ambient temperature (t_a).

EN 61558 specifies five insulation classes for electromagnetic transformers; respective testing temperatures and times are assigned to these classes. Due to the quality of the insulation materials used by Vossloh-Schwabe, VS transformers are only available in the three highest insulation classes B (120°C), F (140°C) and H (165°C). In this case, the quoted temperature refers to the maximum permissible winding temperature during permanent operation.

As luminaire casings made of plastic or sheet metal will discharge heat to varying degrees and because transformer installation conditions can differ, a transformer's winding temperature must be tested within the luminaire. The measured values will show whether the maximum temperature corresponds to the transformer's insulation class.

On request, Vossloh-Schwabe can carry out such luminaire tests to assess built-in components.

Protection symbols



Non short-circuit proof safety transformer



Limited short-circuit proof safety transformer

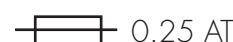

Rated fuse value

t_a 65

Transformer's maximum permissible ambient temperature



Thermal cut-out (reset after disconnection from the mains)

Assembly Instruction for Electromagnetic Transformers

**For mounting and installing electromagnetic transformers
for low-voltage halogen lamps**

Mandatory regulations

DIN VDE 0100	Erection of low voltage installations
EN 60598-1	Luminaires – part 1: general requirements and tests
EN 61558-1	Safety of transformers, power supply units and similar – part 1: general requirements and tests
EN 61558-2-6	Safety of transformers, power supply units and similar – part 2-6: special requirements for safety transformers for general use
EN 61000-3-2	Electromagnetic compatibility (EMC) – part 3: maximum values – main section part 2: maximum values for mains harmonics (device input current up to and including 16 A per conductor)
EN 55015	Maximum values and testing methods for radio disturbance of electrical lighting facilities and similar electrical equipment
EN 61547	Installations for general lighting purposes – EMC immunity requirements

Technical specifications

Mains voltage range	VS safety transformers can be operated at the specified mains voltage within a tolerance range of $\pm 10\%$
Leak current	≤ 0.1 mA per safety transformer
Power factor	$\lambda \geq 0.85$
Compensation	Not required

1

2

3

4

5

6

7

8

9

10

Mechanical mounting

Mounting position

Any

Mounting location

Safety transformers are designed for installation in luminaires or comparable devices. Independent safety transformers do not need to be built into a casing.

Fastening

Preferably using screws, Ø 4 mm

Insulation classes and maximum temperatures

In accordance with EN 61558, safety transformers are assigned to insulation classes on the basis of the insulation materials used (also called insulation material classes for this reason) in the transformers. These insulation classes also prescribe respective maximum winding temperatures that must not be exceeded during normal operation or in the event of overload or short-circuit.

Compliance with the maximum winding temperatures is tested by measuring the resistance of the transformer's copper winding.

Insulation classes for safety transformers in accordance with EN 61558-1

	A	E	B	F	H
Max. winding temperature (1.06 U _N) during normal operation	100 °C	115 °C	120 °C	140 °C	165 °C
Max. winding temperature in the event of overload or short-circuit	200 °C	215 °C	225 °C	240 °C	260 °C

Electromagnetic compatibility (EMC)

Interference

Interference voltage measurements do not have to be taken for luminaires with magnetic safety transformers for operating low-voltage halogen lamps as these are systems with lamp voltages of under 100 Hz and it is assumed that such systems do not cause interference.

Interference immunity

Thanks to the robust design and choice of materials, magnetic safety transformers provide a high degree of interference immunity and are not impaired by admissible mains power interference.

Mains harmonics

Owing to the Ohmic resistance characteristics of low-voltage halogen lamps and the low degree of distortion caused by magnetic transformers, mains harmonics remain low.

Safety functions of VS transformers

Load	Transformer features	
	Unprotected (OS)	With self-locking temperature protection (TS)
Overheating	Is not recorded	Protection is provided by the built-in thermal switch
Short-circuit	Protection must be provided	
Overload	by devices fitted in the luminaire (fuse or thermal switch)	

Should one of the safety functions be triggered, the transformer must be disconnected from the mains, the cause of the fault found and then eliminated.

Dimmer operation

VS safety transformers can be controlled using progressively adjustable phase-cutting leading-edge dimmers for low-voltage halogen lamps.

Reliability and service life

VS safety transformers are designed for a long service life. Provided the specified maximum values for the winding temperature are complied with during operation, a service life of 10 years can be expected. Failure rate: < 0.025%/1,000 hrs

Electrical installation

Conductors Primary conductor cross-section: min. 0.75 mm²,
secondary conductor cross-section: min. 0.75 mm² for 50 W output
and a min. of 1 mm² for 100 W output

Connections Terminal screws: max. torque of 0.5 Nm must not be exceeded

Parallel connection Parallel connection is admissible on the primary side, but is inadmissible on the secondary side

Conductors for low-voltage halogen installations

As the high temperatures associated with the operation of low-voltage halogen lamps place severe demands on lampholder conductors, a skilful combination of conductor and insulation is essential. Tin-plated copper conductors with silicone insulation are recommended for temperatures of up to 180°C at the cable's conductor; nickel-plated copper cables with polytetrafluoroethylene (PTFE) sheathing are recommended for temperatures of up to 250°C. Welded connections ensure the most effective heat discharge. Control measurements should be carried out if other connection types are used, e.g. crimping or plug connectors. To prevent the risk of additional heat generation, the maximum permissible current load must be observed when dimensioning the conductor cross-section. When using electromagnetic transformers, the conductor resistance causes a relatively large voltage drop. This drop in voltage is always associated with a reduction of luminous flux. For instance, an 11% drop in voltage will lead to a 30% drop in luminous flux. For this reason, care should be taken to ensure secondary conductors are kept as short as possible and conductor cross-sections are adequately dimensioned when wiring luminaires. Nevertheless, transformers should not be mounted too near the light source (> 25 cm clearance if possible) to prevent the heat generated by the lamp from raising the ambient temperature above the critical level for a transformer.

As electronic converters operate at high frequencies, consideration must be taken of the skin effect, i.e. the displacement of the electrons from the middle of the conductor to its surface. As a result, the full cross-section of the conductor is no longer used, resistance increases and thus leads to a greater drop in voltage. In addition, AC resistance, which is caused by feed line inductance, can result in an even greater voltage drop. It is therefore recommended that lamp conductors be laid closely parallel or twisted together.

Voltage losses (V) with a two-metre secondary conductor

Working frequency	Load W	Cross-section/Voltage drop		
		0.75 mm ²	1 mm ²	1.5 mm ²
50 Hz (electromagnetic transformers) any wiring layout	50	0.38 V	0.29 V	0.2 V
	100	0.74 V	0.56 V	0.39 V
40 kHz (electronic converters) any wiring layout (loops)	50	1.4 V	1.25 V	1.2 V
	100	3.3 V	3.1 V	3 V
40 kHz (electronic converters) wires twisted together or closely parallel	50	0.5 V	0.45 V	0.35 V
	100	1.2 V	1 V	0.85 V

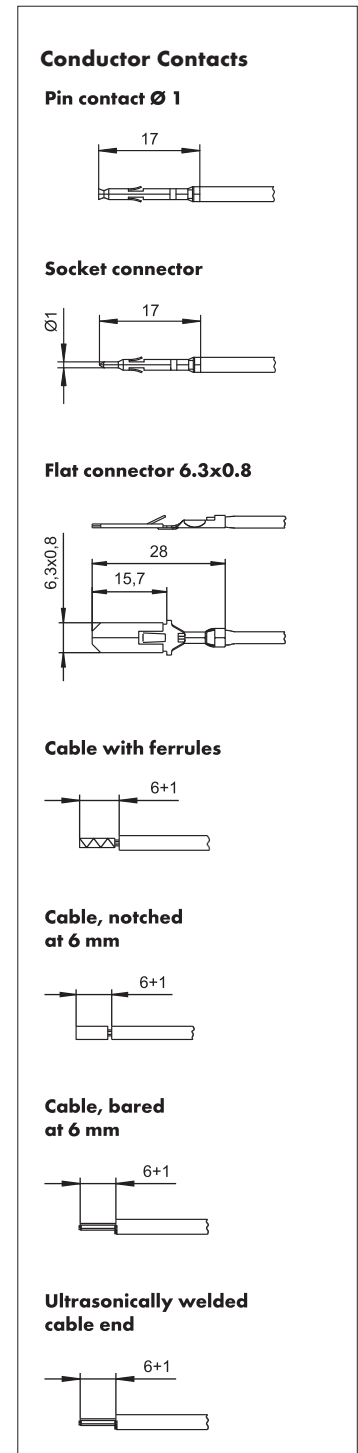
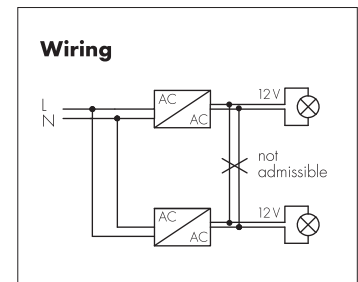

1
2
3
4
5
6
7
8
9
10

Conductors for installations with halogen lamps

All conductors must be selected to suit the luminaire conditions (see table) in terms of material, cross-section and insulation. Testing these conductors under worst case conditions is essential as the commonly occurring high temperatures considerably reduce the conductivity of the conductor and hence its current-carrying capacity.

Insulation	Conductor Material	Cross-section mm ²	Mains voltage V	Max. temperature °C
SI	Cu tin-plated (Cu vz)	0.75	300	180
FEP	Cu tin-plated (Cu vz)	0.75	300	180
PTFE	Cu nickel-plated (Cu vn)	0.75	500	250
PTFE	Cu nickel-plated (Cu vn)	1	500	250
PTFE	Ni	1	500	250
PTFE	Ni	1.5	500	250

Lampholders

For low-voltage halogen lamps

With the exception of B15d bases, the low-voltage sector is dominated by pin bases, which are fitted with a variety of different pin distances and diameters. Apart from classic lampholders that ensure both the electrical contact and the correct positioning of the lamp, connection elements are also available. These components are solely responsible for establishing electrical contact and are used in cases where, for instance, the regulations demand that the lamp be attached to its reflector (e.g. cold-light reflector lamps with GZ4 and GX5.3 bases). Extremely high temperatures are also generated when operating low-voltage halogen lamps as a result of the tungsten-halogen cycle and high lamp currents. In addition, the respective luminaires are often of very compact design, which leads to heat accumulation and thus to high internal temperatures. The materials the lampholder is made of thus play a vital role for the luminaire's operating safety and the lamp's service life. In addition to tried-and-tested materials – ceramics for casings and mica for covers – ever more frequent use is being made of highly heat-resistant plastics like LCP (liquid crystal polymer for e.g. G4, GU4, GX5.3, GU5.3 and GY6.35 lampholders) and PPS (polyphenylene sulphide for G4 lampholders). Plastic lampholders provide clear advantages: narrow dimensional tolerances, no material fractures, low weight and clip-attachment options.

The type of contact also plays an important role. Conventional contacts are only attached to one side of the lamp pin. In contrast, additional contact points – known as multipoint contacts – lead to a reduction of current density at the point of transition from the lamp pins to the lampholder contact and with that to a decrease in temperature. These contacts provide the further advantage of ensuring superior heat dissipation from the lamp pins to the conductor. The temperature advantage of multipoint contacts in defined conditions (including welded-on conductors) can amount to as much as 100 °C. In extremely rare cases, due to the high internal pressure in the bulb, it is possible for the lamp to shatter. For reasons of fire prevention (high temperature of the glass bulb), the lamp's components must be prevented from falling out. Enclosed luminaires meet these requirements. Open luminaires, however, may only be operated using lamps with enclosed bulbs or low-pressure lamps. Lamps of this kind are suitably marked with pictograms on the lamp's packaging and in the lamp manufacturer's documentation. Lamps marked with pictogram No. 1 are suitable for use with open luminaires, whereas those marked with pictogram No. 2 may only be used in enclosed luminaires.

Lampholders for low-voltage halogen lamps are equipped with mounted cables or with plug-type connectors. In addition to the various lampholders contained in the catalogue, further lampholder models with various cable lengths and of various qualities as well as lampholders with plug-connected cables can be made available on request.

VS lampholders for the UL market and UL approved leads are available for all common lamp types.

Further information can be found at www.unvlt.com.



1



2

Bases of the most widely used low-voltage halogen lamps

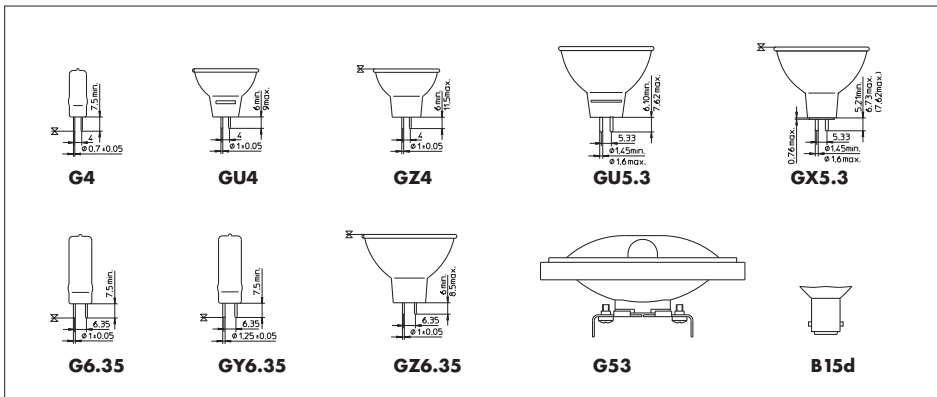

Lampholders for mains voltage halogen lamps

A major factor in lampholder design is the lamp temperature, which is determined by the tungstenhalogen cycle, high lamp current and high wattages. Lampholder casings can be made of ceramics, metal or the ever more popular highly heat-resistant thermoplastics like PET (polyethyleneterephthalate), PPS (polyphenylene sulphide) and LCP (liquid crystal polymer). The most suitable contact materials for these temperatures are nickel, copper-nickel alloys or copper materials with sufficiently thick nickel coatings. For tubular lamps (R7s base), the standard IEC 60061-2 7005-53 prescribes the respective contact pressure of lampholder contact materials.

Although halogen lamps offer twice the service life of general-purpose light bulbs, this can only be fully realised if luminaire manufacturers observe the recommended maximum temperatures at the lamp's pinch point. There is usually a welded-on molybdenum plate at the pinch point where the lamp base pins join the lamp filament. Lamp manufacturers ascertain the pinch temperature at this point, which is generally located within the lamp's quartz glass, using specially prepared measuring lamps. The pinch temperature is a critical thermal reference point which must not be exceeded within the luminaire.

VS lampholders for the UL market and UL approved leads are available for all common lamp types.

Further information can be found at www.unvlt.com.

The bases of the most widely used mains voltage incandescent lamps

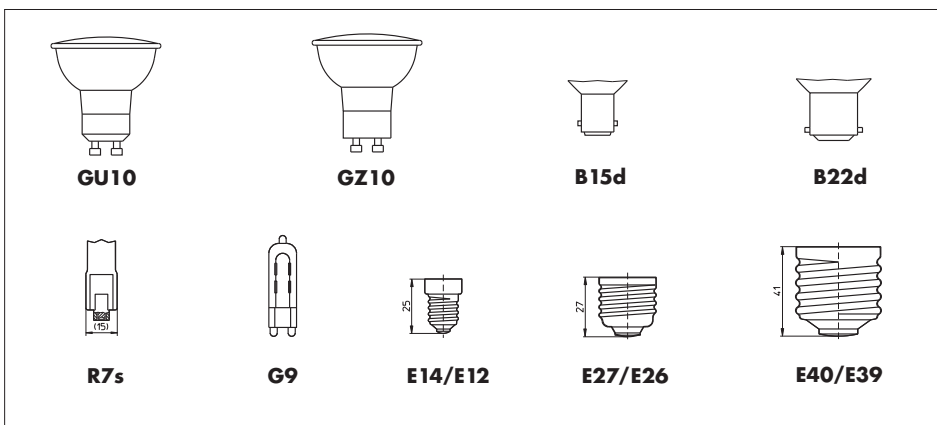

Retrofit Lamps

So-called retrofit lamps have been introduced to the market thanks to LED technology. Some of these can significantly exceed the weight of the original lamp. When using such lamps in luminaires already introduced to the market (with conventional lampholders), but also for new luminaire designs (with conventional lampholders), this can cause a greater risk with regard to disconnecting the power supply and, in addition, can lead to greater mechanical damage.

1

2

3

4

5

6

7

8

9

10

6-80 W EMERGENCY LIGHTING MODULES



EMERGENCY LIGHTING

Emergency lighting systems spring to life any time normal artificial lighting systems fail. Emergency lighting is designed to ensure that work can continue without risk, that staff can safely leave any workplaces involving special hazards and that there is sufficient lighting to illuminate rescue paths/routes as well as to avoid panic situations.

As power cuts result in a risk to safety, legislation has been enacted in the form of the Health and Safety at Work Directive (Europe) and the Health and Safety at Work Acts of the individual European countries (e.g. Germany), all of which stipulate that emergency lighting must be provided. The requirements placed on emergency lighting installed in places of public assembly and public buildings are governed by supplementary directives and laws.

Vossloh-Schwabe's emergency lighting units are designed for use with T5, T8 and compact fluorescent lamps and can be operated with electromagnetic or electronic ballasts.

VS emergency lighting units are suitable for both continuous and standby circuits with a nominal operating period of 1 or 3 hours.

6

Emergency Lighting Modules for TC and T Lamps

Emergency lighting modules with self-diagnosis function

348–349

Technical details for emergency lighting modules

350–356

General technical details

366–374

Glossary

375–377

1

2

3

4

5

6

7

8

9

10

Emergency Lighting Modules 6 to 80 W with Self-Diagnosis Function

EMXs – Emergency lighting modules

For one-, two-, three- or four-lamp operation with standard and dimmable electronic or magnetic ballasts

EB phase is switched off during emergency operation

Short circuit protection

RoHS-compliant (excluding rechargeable batteries)

5-pin technology and therefore EMC-compliant even during emergency operation

Suitable for protection class I

EN 61347-1, EN 61347-2-7

Suitable for systems in accordance with VDE 0108 or EN 50172

Not suitable for lamps with an integrated starter

Cyclic charging of the NiMH battery is micro-processor controlled, which can extend battery life by up to 30%

Dimensions (LxWxH): 210x31.4x21.5 mm

Fixing hole distance: 205.5 mm

Nominal voltage: 230 V \pm 10%, 50-60 Hz

Ambient temperature t_a : 0 to 50 °C

Unit: 25 pcs.

These VS emergency lighting modules include an automatic self-diagnosis feature that performs a two-minute function test of the device, the lamp and the battery every seven days.

In addition, the operating period is tested every 12 months with subsequent battery reactivation.

Optical status display

- Red LED, flashing intermittently: defective lamp. The status display will be reset approx. one minute after the fault has been rectified.
- White LED, not illuminated: if connected to the power supply, the LED must turn green after a maximum of five minutes. If not, the device either has no voltage supply or the emergency lighting module is defective.
- Red LED, permanently flashing: battery capacity is too low or the battery supply line has been interrupted.
- Green LED: fully functional.



Emergency lighting module

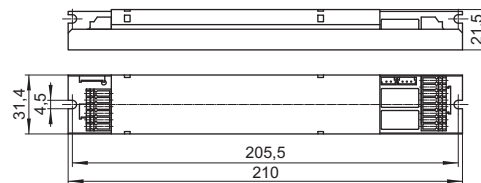

LED

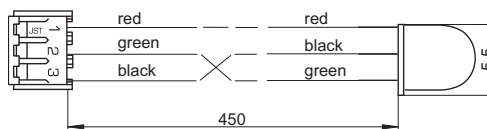

Rechargeable battery

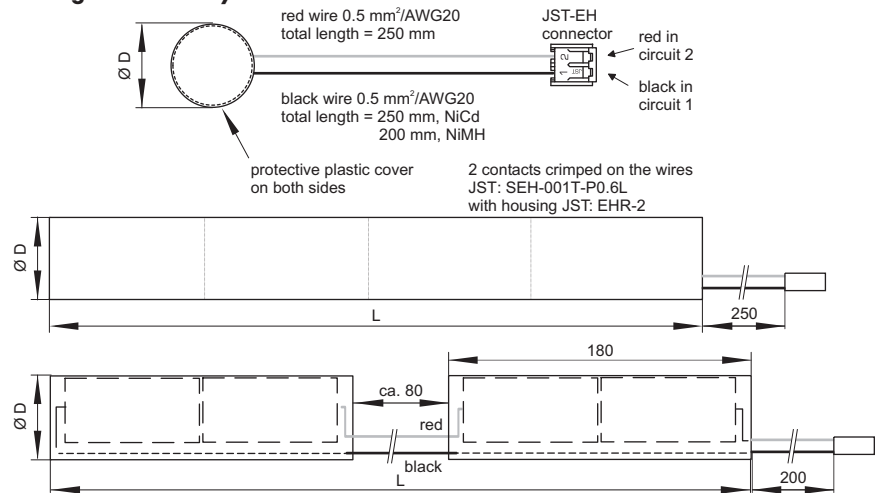

Emergency Lighting Modules 6 to 80 W with Self-Diagnosis Function

EMXs – Emergency lighting modules

Type	Ref. No. Module	Ref. No. Battery	Nominal operating period hrs.	Rechargeable battery type	Dimensions LxD (Ø) of battery mm	Test function	Weight module g	Weight battery g
EMXs 180.000	188792	188823	1	4.8V 1.8Ah NiCd	1 / 190 x 23	automatic	160	200
EMXs 180.001	188793	188824	3	4.8V 4.5Ah NiCd	1 / 240 x 33	automatic	160	490
EMXs 180.002	188794	188825	1	4.8V 1.8Ah NiMH	1 / 200 x 17	automatic	160	140
EMXs 180.003	188795	188826	3	4.8V 4.5Ah NiMH	2 / 450 x 19	automatic	160	320

Circuit diagrams see page 354–356

HOLDERS for Rechargeable Batteries for Emergency Lighting Modules

Material: PC (188828: PBT)

Type: Rechargeable Battery Holder

Ref. No.	For rechargeable battery type	Dimensions (mm)					
		a	b	c	d	e	f
188827	4.8V 1.8Ah NiCd	35.0	18.0	26.3	26.7	13.0	5.5
188828	4.8V 4.5Ah NiCd	39.0	23.2	36.2	37.3	12.4	6.0
188829	4.8V 1.8Ah NiMH	22.5	15.0	22.8	22.5	8.0	4.0
188829	4.8V 4.5Ah NiMH	22.5	15.0	22.8	22.5	8.0	4.0

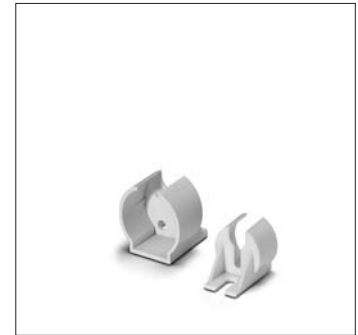
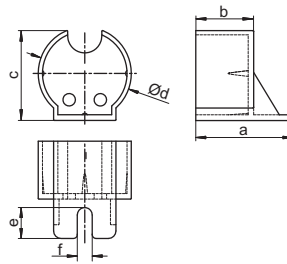

It is recommended to use two holders per rechargeable battery to ensure optimum hold.

Table of suitable lamp types

Lamp type	Lamp nominal output W
T8	15, 18, 32, 36, 58, 70
T5 HE	14, 21, 28, 35
T5 HO	24, 39, 49, 54, 80
T5	6, 8, 13
T-R5 (T-R16)	22, 40, 55, 60
T-R (T29-R)	22, 32, 40
TC-L/TC-F	18, 24, 36, 40, 55, 80
TC-DEL	10, 13, 18, 26
TC-TEL	13, 18, 26, 32, 42, 57, 70
TC-SEL	7, 9, 11
TC-DD (2D)	10, 16, 21, 28, 38, 55

Luminous flux factor of lamps during emergency operation

Lamp nominal output W	Luminous flux factor* %
6	43.0
8	32.0
18	13.0
28	9.0
32	7.0
35	7.0
36	7.0
49	4.7
54	4.3
55	4.7
58	5.2
70	4.3
80	3.7

* Theoretically defined reference values at 25°C ambient temperature

6

Emergency Lighting Modules for TC and T Lamps

Assembly instructions for emergency lighting modules

Electrical installation

Emergency lighting module display

Circuit diagrams

351-356

351-352

353

354-356

General technical details

Glossary

366-474

375-377

Emergency lighting modules are designed for operation with 6 to 80 W, 4-pin fluorescent lamps. Luminaires with integrated emergency lighting modules can be operated using a continuous or standby circuit.

Technical specifications	EMXs emergency lighting modules
Permissible mains voltage	230 V ±10%
Permissible mains frequency	50-60 Hz
Power consumption with standby circuit	3 W
Nominal period of operation	1 to 3 hours, depending on the type of rechargeable battery
Batteries	NiCd or NiMH
Ambient temperature	0* to 50 °C
Charging time	24 hrs
Protection class	1
Degree of protection	IP20
Certification	CENELEC
Tested in accordance with	EN 61347-2-7
Suitable for systems compliant with	VDE 0108 / EN 50172
Casing	Metal (zinc-plated)
Installation outside the luminaire	Permissible lead length between the emergency lighting module and the lamp must not exceed two metres.
Luminous flux factors during emergency operation	See the table on page 349, values apply to 25 °C ambient temperature.

* Ignition in progress; the values of the colour rendering index and the luminous flux factor may deviate.

Assembly Instructions for Emergency Lighting Modules

For mounting and installing of emergency lighting modules

If the emergency lighting module is integrated in the luminaire, the LED and battery have to be wired separately, i.e. not in parallel with the mains or lamp. Emergency lighting modules must be fixed in a suitable spot within the luminaire (4-mm bore holes for mounting).

In the interest of maximising battery capacity and service life, care must be taken to ensure the battery is positioned at the coolest part of the luminaire. The ambient temperature of the battery must not exceed 50 °C. Emergency lighting modules must not be mounted on surfaces that ignite, melt or undergo some other thermal change at a temperature of 60 °C. Moreover, emergency lighting modules must not be operated in explosion-endangered enclosed spaces.

Electrical installation

The respective ordinances and standards valid at the place of operation must be observed for installation purposes. Emergency lighting modules and luminaires must only be installed by trained staff. Operating voltages exceed 50 V. Caution: potentially fatal hazard!

Prior to first operation of emergency luminaires, all covers must be attached. Furthermore, care must be taken to ensure that the supply voltage complies with the specifications on the type plate and the protective conductor is connected.

1. Fuse
2. Light switch
3. Room lighting
4. Emergency luminaires

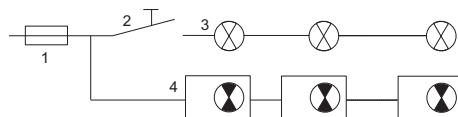

Emergency luminaires must be connected to a direct phase to enable mains monitoring and ensure constant charge retention. This phase must be connected to the group fuse of the regular room luminaire. Emergency luminaires are generally delivered with uncharged batteries and must be connected to the mains for at least 48 hours to be fully functional or for approx. 10 minutes for mains operation in the case of a continuous circuit.

Additional information for optimising EMC

Information on the installation of electronic ballasts for optimising EMC

To ensure good radio interference suppression and the greatest possible operating safety, the following points should be observed when installing electronic ballasts:

- Conductors between the EB and the lamp (HF conductors) must be kept short (reduction of electromagnetic interference). High-potential lamp conductors must be kept as short as possible, in particular with tubular lamps. Lamp conductors of this kind are labelled with an * in the wiring diagram on the type plate.
- Mains and lamp conductors must be kept separate and if possible should not be laid in parallel to one another. The distance between HF and mains conductors should be as large as possible, ideally > 5 cm. (This prevents the induction of interference between the mains and lamp conductors.)
- The mains conductor within the luminaire must be kept short (to reduce the induction of interference).
- Devices must be properly earthed. EBs require secure contacts to the luminaire casing or must be earthed using a PE connection. This PE connection should be effected using an independent conductor to achieve better dissipation of the leak current. EMC improves at frequencies greater than 30 MHz.
- The mains conductor must not be laid too close to the EB or the lamp (this is especially important in the event of through-wiring).
- Mains and lamp conductors must not be crossed. Should this be impossible to avoid, conductors should be crossed at right angles to one another to avoid inducing interference between mains and HF conductors.
- Should conductors be wired through metal parts, such conductors must always be additionally shielded (e.g. with an insulating sleeve or grommet).

Maintenance

With regard to system maintenance and control, care must be taken to ensure compliance with any ordinances and standards governing emergency lighting at the place of installation.

Prior to opening lamp covers, the following procedure must be observed:

1. Disconnect luminaires from the mains voltage.
2. Remove cover.
3. Disconnect battery from the emergency lighting module (disconnect the plug).

VS recommends connecting control LEDs to be visible on the outside of emergency luminaires to enable simple and regular control of emergency luminaires and emergency lighting modules.

Changing batteries

Batteries need to be replaced if the operating period of luminaires falls short of 60 minutes in the case of 1-hour operation and 180 minutes for 3-hour operation, respectively. Emergency lighting modules have a status display for this purpose.

Spent batteries must be replaced with the manufacturer's original batteries only. Furthermore, the polarity of the batteries must be strictly observed. The battery supply lines of the emergency lighting module are marked as follows:

red = +; black = -

Emergency lighting module display

Normal operation is indicated by a green LED. During emergency operation or for as long as the battery remains fully discharged, the LED is off (i.e. does not glow). The LED will flash red if the battery is missing or not properly connected.

Automatic test of emergency lighting modules

In the case of emergency luminaires with emergency lighting modules, the operational readiness of the device, the lamp and the battery is tested automatically every seven days. In addition, battery capacity is measured during a simulated loss of mains power every 12 months.

The first capacity test will be carried out seven days following initial installation or any repair work. The LED must be checked after the first self-test. A green LED indicates all is in working order, any other display indicates a problem.

The device features a two-colour LED display to indicate that the emergency luminaire is ready for use.

Optical status display

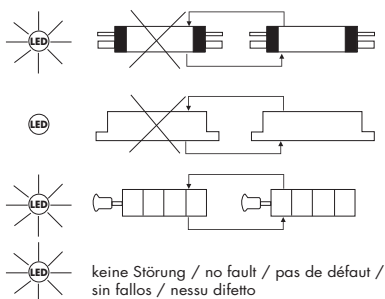

Emergency luminaires merely require regular visual inspection of the status display (LED) and the luminaire itself.

Red LED, flashing intermittently	During initial operation, a lamp recognition test is first carried out. Prior to and during this test, the LED will be red and flash intermittently.
White LED, not illuminated	If connected to mains power, the LED must turn green after a maximum of five minutes. If not, the device has no mains voltage or the emergency lighting module is defective.
Red LED, continuous flashing	Battery capacity is too low or the battery supply line has been interrupted. The warning light will go off again as soon as the problem has been rectified.
Green LED	Fully functional.

Notes

Vossloh-Schwabe accepts no liability for any direct, indirect or incidental damage caused by putting a device to any improper use, i.e. any use not expressly permitted by VS. Similarly, Vossloh-Schwabe accepts no liability for third-party claims arising from putting a device to any improper use, i.e. any use not expressly permitted by VS. Emergency lighting modules must not be opened or modified in any way. The components of emergency lighting modules must be replaced with original parts only.

Should emergency lighting modules be damaged in a way that suggests it cannot be operated safely, the luminaires or emergency lighting modules, respectively, must not be operated. VS reserves the right to make changes to diagrams, weights, tables of dimensions or other such details included in the catalogue or instructions for use without prior notice if such changes prove to be necessary or are made as a result of technological progress. VS emergency lighting modules are patent protected.

Any act of producing counterfeit VS products will be prosecuted according to criminal and civil law.

Caution!

Emergency lighting modules from VS must not be operated with amalgam lamps.

1

2

3

4

5

6

7

8

9

10

Circuit Diagrams

For VS emergency lighting modules

Notes for wiring:

- The distance between mains lead and lead 8 should be as large as possible
- Leads 2/4/6/8 must be kept short

Circuit diagrams – 1-lamp operation

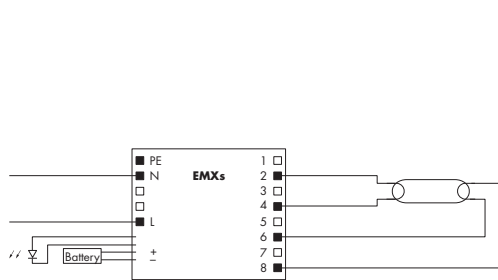

1-lamp operation
without electronic or electromagnetic
ballast (continuous circuits)

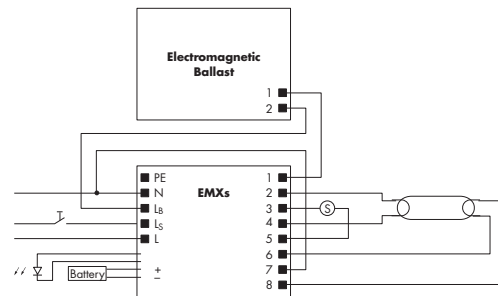

1-lamp operation
with electromagnetic ballast

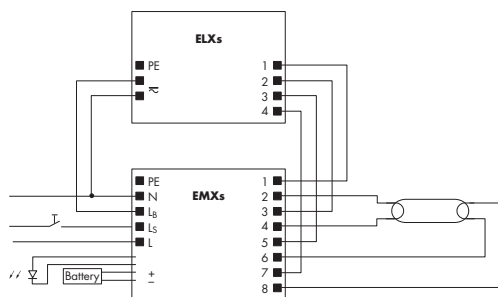

1-lamp operation – Warm start
with electronic ballast ELXs

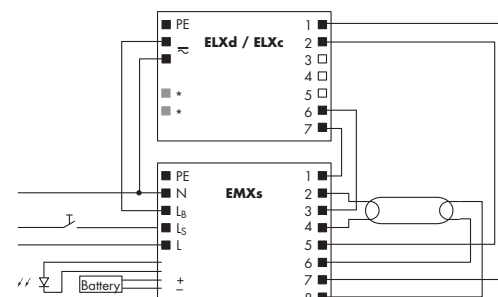

*nur bei dimmbaren Vorschaltgeräten/only with dimmable ballasts/juste avec ballasts graduables/solo con alimentatori dimmerabili/sólo con reactancia regulable

1-lamp operation – Dimming / Warm start
with electronic ballast ELXd / ELXc

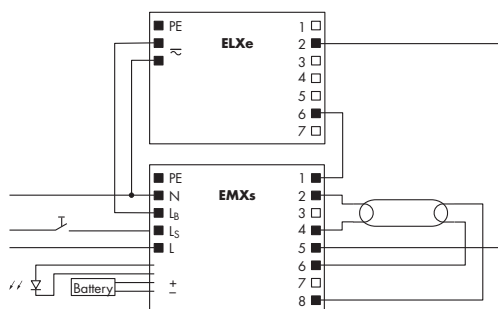

1-lamp operation – Instant start
with electronic ballast ELXe

Circuit diagrams – 2-lamp operation

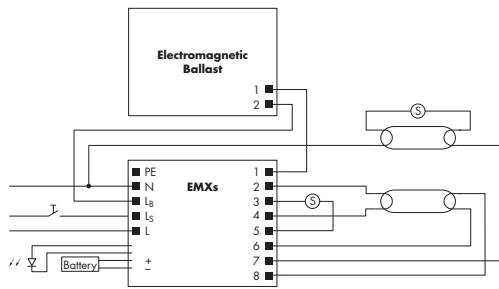

2-lamp operation
with electromagnetic ballast

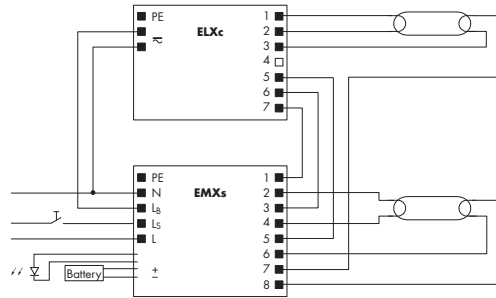

2-lamp operation - Warm start
with electronic ballast ELXc

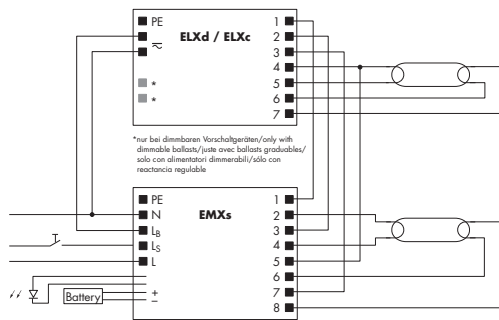

2-lamp operation - Dimming / Warm start
with electronic ballast ELXd / ELXc

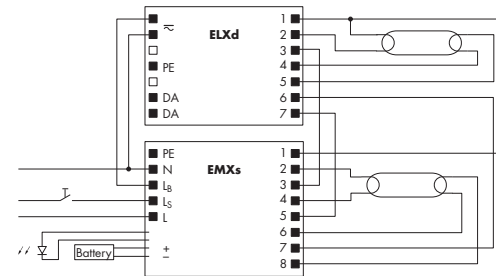

2-lamp operation - Dimming
with electronic ballast ELXd

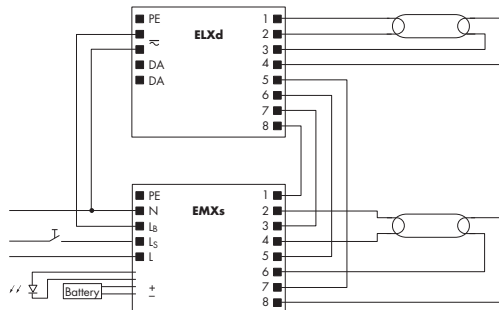

2-lamp operation - Dimming
with electronic ballast ELXd

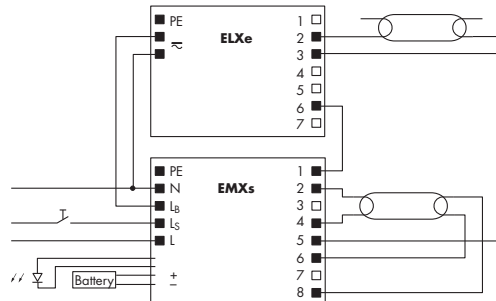

2-lamp operation - Instant start
with electronic ballast ELXe

Circuit diagrams – 3-lamp operation

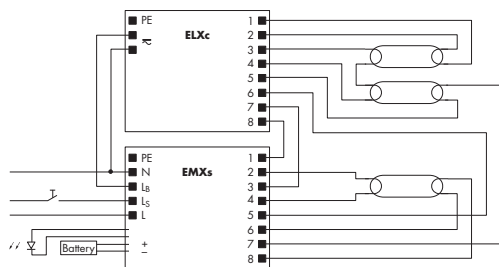

3-lamp operation - Warm start
with electronic ballast ELXc

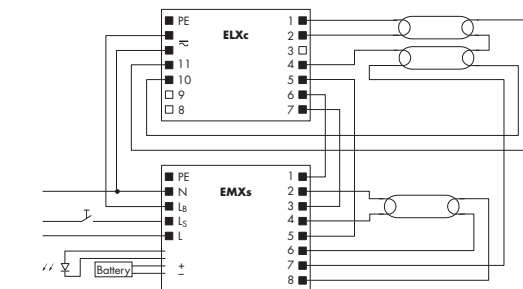

3-lamp operation - Warm start
with electronic ballast ELXc

1

2

3

4

5

6

7

8

9

10

Circuit diagrams – 3-lamp operation

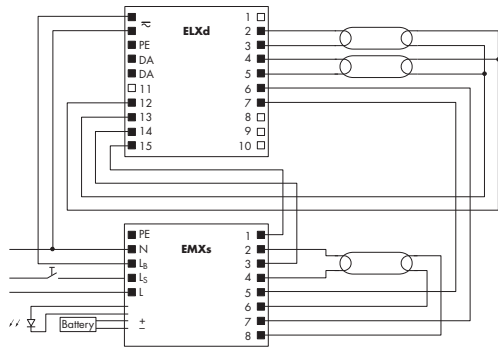

3-lamp operation - Dimming
with electronic ballast ELXd

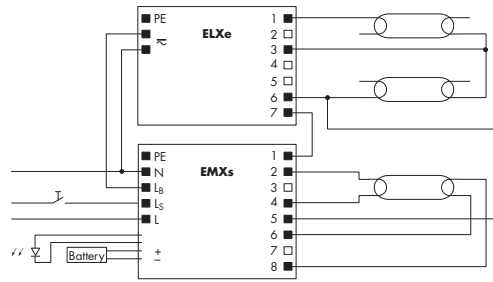

3-lamp operation - Instant start
with electronic ballast ELXe

Circuit diagrams – 4-lamp operation

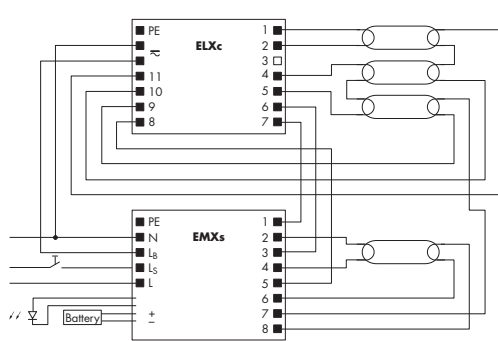

4-lamp operation - Warm start
with electronic ballast ELXc

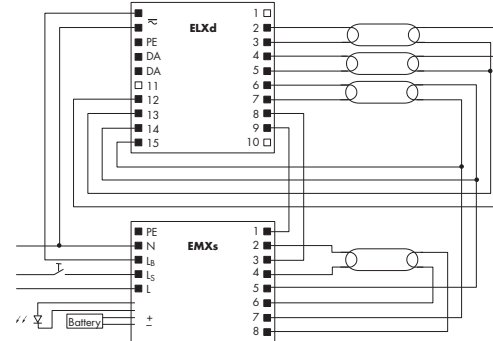

4-lamp operation - Dimming
with electronic ballast ELXd

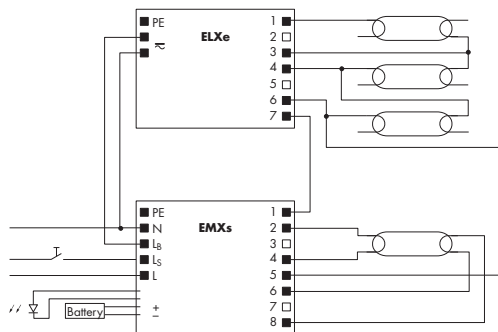

4-lamp operation - Instant start
with electronic ballast ELXe

1

2

3

4

5

6

7

8

9

10

LIGHTING TECHNOLOGY COMPONENTS FOR THE UL MARKET



At the beginning of 2010, the US American sales office, Vossloh-Schwabe Inc., was merged with Universal Lighting Technologies, Inc., a further Panasonic subsidiary.

Universal Lighting Technologies, Inc., produces some of the world's most advanced linear fluorescent, compact fluorescent, HID, eHID, and LED solutions for commercial lighting applications.

The following pages serve to give you some idea of the highly extensive product range of VS lampholders for the UL market.

A global leader in research and development since 1947, Universal proudly features recognized and trusted brands like Universal® and Triad®, with a reputation for innovations that can significantly reduce energy costs with high efficiency solutions, installer-friendly options, and greater flexibility for fixture designs.

Advanced lighting technologies such as step-dimming, 0-10 V analog dimming, DALI dimming and energy management systems help meet specific application and user requirements.

The EVERLINE® brand of LED products leads the industry on performance, flexibility and quality. Whether developed individually or to be part of a system, EVERLINE makes it easy to configure a full featured, high efficiency LED system.

Further information can be found at www.unvlt.com.



Nashville, TN 37214
Phone: 615-316-5100
www.unvlt.com



Energy Management & Controllable Lighting



Linear Fluorescent Ballasts



Electronic & Magnetic HID Ballasts

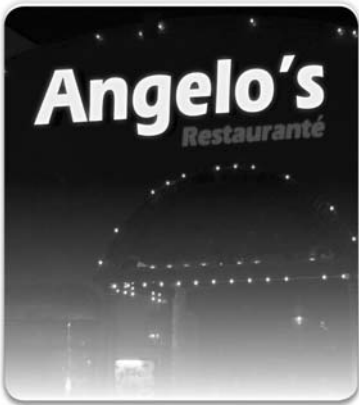

Sign Ballasts



Compact Fluorescent Ballasts



LED Systems

E39 Porcelain Lampholders

For discharge lamps with base E39 / Mogul base

Screw terminals: max. 16-12 AWG, solid conductor

E39 lampholders

Casing: porcelain, white

Nominal rating: 2000 W/600 V/6 kV pulse rating

Cylindric shape

Screw shell: brass, nickel-plated

Central contact: brass, nickel-plated

Spring loaded central contact

Screw terminals: 18-14 AWG

Fixing distance: 35 mm (1.378")

Thread measured in inches No. 8-32 UNC (ISO)

Weight: 190 g, unit: 50 pcs.

Type: 12870/12876

Ref. No.: 109014

Ref. No.: 109518 with lamp safety catch

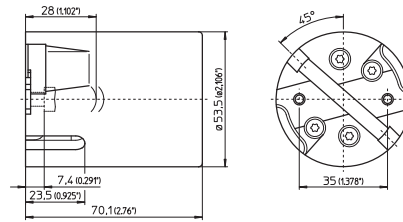

GU6.5 Lampholders

For single-ended discharge lamps

Additional lead lengths and types on request

GU6.5 lampholders

Casing: ceramic, cover plate: PPS

Nominal rating: 2 A/250 V/5 kV pulse rating

Leads: Cu nickel-plated, stranded conductors 18 AWG,

PTFE-insulation, length: 305 mm (12")

Weight: 20 g, unit: 100 pcs.

Type: 34515 fixing holes for screws M3 (#4)

Ref. No.: 534218

Type: 34516 threaded bushes for screws M3 (#4)

Ref. No.: 534219

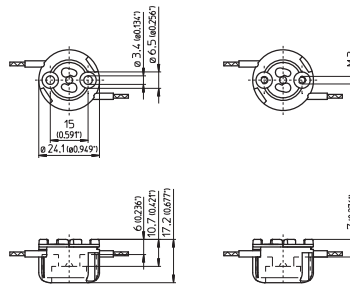

GU6.5 lampholders

Casing: ceramic, cover plate: PPS

Nominal rating: 2 A/250 V/5 kV pulse rating

Leads: Cu nickel-plated, stranded conductors 18 AWG,

PTFE-insulation, length: 305 mm (12")

Weight: 20 g, unit: 100 pcs.

Type: 34525 dia. 22 mm

Ref. No.: 535783

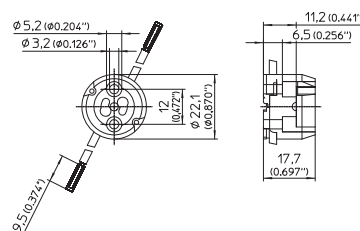

GX10 Lampholders

For single-ended discharge lamps

GX10 lampholder

Casing: steatite, cover plate: PPS

Nominal rating: 2/500/5 kV

Leads: Cu nickel-plated, stranded conductors

18AWG, PTFE insulation, length: 305 mm (12")

Weight: 25 g, unit: 100 pcs.

Type: 31550

Ref. No.: 543153

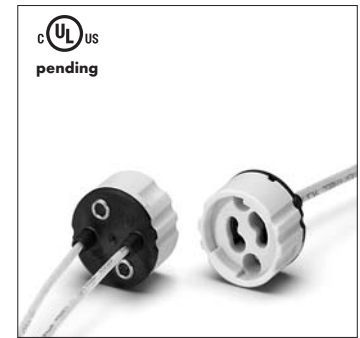
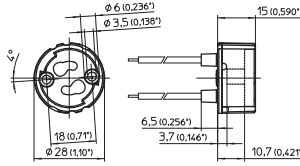

G12 Lampholders

For single-ended discharge lamps

Additional lead lengths and types on request

G12 lampholders

Casing: ceramic, cover plate: PPS, black

Nominal rating: 660 W/600 V/5 kV pulse rating

Contacts: Ni

Leads: 18 AWG, SF-2

Fixing holes for screws M4 (#8)

Weight: 56/144 g, unit: 25 pcs.

Type: 31936

Ref. No.: 108257 lead length: 460 mm (18")

Ref. No.: 526211 lead length: 1525 mm (60")

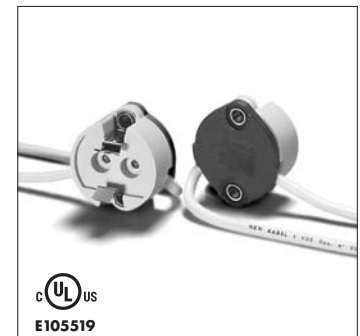
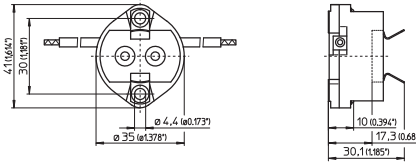

2G11 Lampholders for Twin-tube 4-pin Lamps

For Single-ended Compact Fluorescent Twin-tube 4-pin Lamps

Nominal rating: 660W/600V

Degree of protection: IP20

Quick-connect twin terminals: 18AWG solid or stranded solder-dipped (lamp circuit)

Quick-connect terminals: 18AWG solid or stranded solder-dipped (starter circuit)

All products in this chapter carry a T rating of T120 acc. to UL standards (shunted versions correspond to Circle-I requirements).

2G11 back panel or bracket mount lampholders

Casing: PBT GF, white

Lateral pivots for bracket 105824 (see page 179)

Rear mounting holes for self-tapping #8 screws

Front mounting holes for #4 screws (M3)

Weight: 12.7 g, unit: 500 pcs.

Type: 36051

Ref. No.: 101489

Ref. No.: 532687 with internal shunt

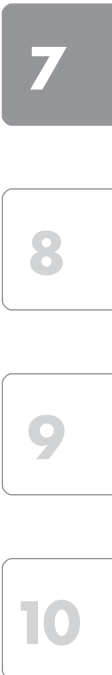
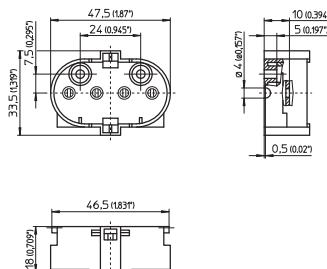

G24 Lampholders for Quad-tube Lamps, GX24 Lampholders for Triple-tube Lamps

For Single-ended Compact Fluorescent Bi-pin and 4-pin Lamps

The drawings and photos contained in this chapter only show lampholders for lamps with base G24d-1.
All T ratings in this chapter refer to IEC standards

When mounting lampholder remember triple-tube GX24d/GX24q lamps are wider than lampholder.
When using central-mounting hole provisions must be made to prevent lampholder rotation.

All lampholders with quick-connect terminals (UL File No. E110363):
18AWG solid or stranded solder-dipped

G24, GX24 snap-in lampholders
Casing: PBT GF, white, T140 (acc. to IEC)
Nominal rating: 660 W/600 V
Quick-connect twin terminals: 18AWG (lamp circuit)
For G24q, GX24q lampholders:
quick-connect terminals: 18AWG (starter circuit)
Rear split pins for wall thickness
0.8-1.7 mm (0.031-0.067")
Width of split pin: 4.5 mm (0.177")

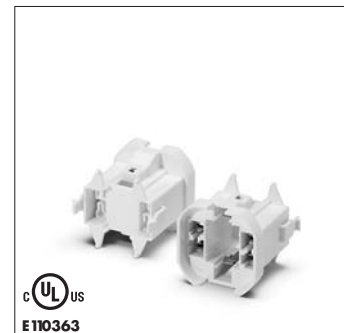
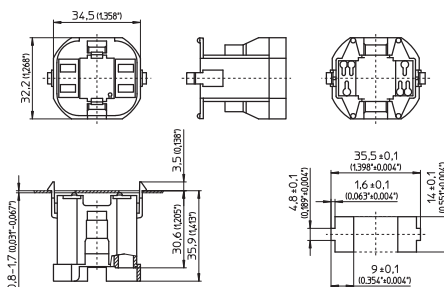

Type	Ref. No.	Base	Output (W)	Weight (g)	Unit (pcs.)
72101	528116	G24d-1/GX24d-1	8, 10, 13 / 13	10.4	500
72102	528117	G24d-2/GX24d-2	18 / 18	10.4	500
72103	528118	G24d-3/GX24d-3	26 / 26	10.4	500
72111	528120	G24q-1/GX24q-1	10, 13 / 13	12.3	500
72112	528121	G24q-2/GX24q-2	18 / 18	12.3	500
72113	528122	G24q-3/GX24q-3	26 / 26, 32	12.3	500
72119	528126	GX24q-3/-4*	26, 32 / 42	12.3	500
72114	528123	GX24q-4	42	12.3	500
72115	528124	GX24q-5	57	12.9	500
72116	528125	GX24q-6	70	12.9	500

Shunted Version

72111	528128	G24q-1/GX24q-1	10, 13 / 13	12.3	500
72112	528129	G24q-2/GX24q-2	18 / 18	12.3	500
72113	528130	G24q-3/GX24q-3	26 / 26, 32	12.3	500
72119	528134	GX24q-3/-4*	26, 32 / 42	12.3	500
72114	528131	GX24q-4	42	12.3	500
72115	528132	GX24q-5	57	12.9	500
72116	528133	GX24q-6	70	12.9	500

* Lampholders 528126 and 528134 may only be used in luminaires that are operated with electronic ballasts that have been certified according to the applicable standards and that cover the luminaire performance range of 26, 32 and 42W.

G13 Push-through Lampholders for T8, T12 Lamps

Lampholders for fluorescent lamps T8 and T12 / Medium Bi-Pin

Nominal rating: 660 W/600 V
 Push-in twin terminals: 18 AWG, solid or stranded conductors, tinned
 Lateral fixing clips for wall thickness 0.4-2 mm (0.016"-0.079")

Casing: PC, white
 (shunted versions: PBT, white)
 Front plate: PBT GF, white

All products in this chapter carry a T rating of T120 acc. to UL standards (shunted versions correspond to Circle-I requirements).

G13 push-through lampholders for lamps T8, T12

Pin support for reliable contact
 Lamp axis: 17 mm (0.67")

Weight: 5,4 g, unit: 1000 pcs.
 Type: 26300/26302 with stop

Ref. No.: 551271

Ref. No.: 551275 internally shunted

Type: 26310/26312 without stop

Ref. No.: 551272

Ref. No.: 551277 internally shunted

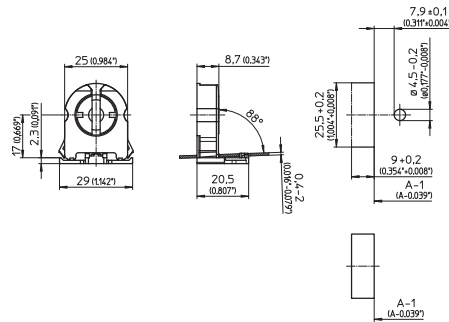

G13 push-through lampholders for lamps T8, T12

Pin support for reliable contact
 Lamp axis: 23 mm (0.906")

Weight: 6.6 g, unit: 1000 pcs.
 Type: 29100/29125 with stop

Ref. No.: 545845

Ref. No.: 545840 internally shunted

Type: 29101/29126 without stop

Ref. No.: 545849

Ref. No.: 545842 internally shunted

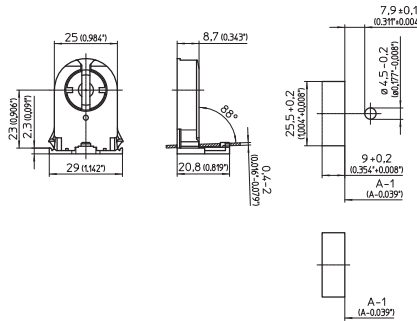

G13 push-through lampholders for lamps T8, T12

Pin support for reliable contact
 Lamp axis: 31 mm (1.220")

Weight: 7.8 g, unit: 1000 pcs.
 Type: 28700/28725 with stop

Ref. No.: 109342

Ref. No.: 109376 internally shunted

Type: 28701/28726 without stop

Ref. No.: 109343

Ref. No.: 109377 internally shunted

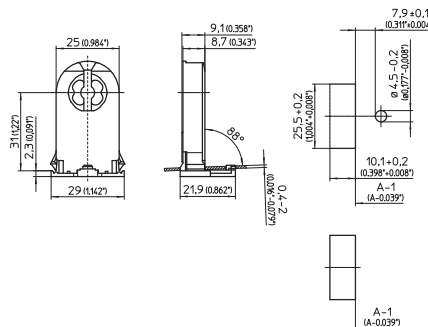

1

2

3

4

5

6

7

8

9

10

G5 Lampholders

Lampholders for fluorescent lamps with base G5

Nominal rating: 120 W/600 V

Push-in twin terminals: 18 AWG, solid or stranded conductors, tinned

Lateral fixing clips for wall thickness 0.5-1.5 mm (0.020"-0.059")

All products in this chapter carry a T rating of T120 acc. to UL standards (shunted versions correspond to Circle-I requirements).

G5 push-through lampholders

Lamp axis: 20 mm (0.787")

Casing: PBT GF/PC, white, rotor: PBT GF, white

Weight: 4.1 g, unit: 1000 pcs.

Type: 09432/09433

Ref. No.: 545933 with stop

Ref. No.: 545935 without stop

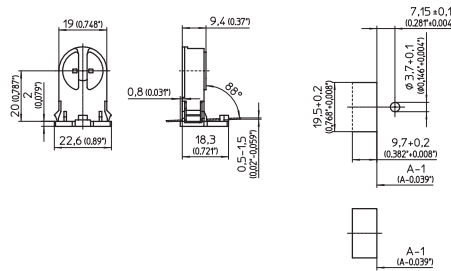

G5 push-through lampholders

Lamp axis: 25 mm (0.984")

Casing: PBT GF/PC, white, rotor: PBT GF, white

T140, nominal rating: 2/500

Weight: 4.5 g, unit: 1000 pcs.

Type: 09434/09435

Ref. No.: 545937 with stop

Ref. No.: 545939 without stop

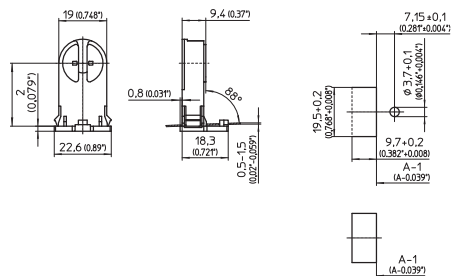

G5 push-through lampholders

Lamp axis: 15 mm (0.591")

Casing: PBT GF/PC, white, rotor: PBT GF, white

Weight: 3.5 g, unit: 1000 pcs.

Type: 09420/09421

Ref. No.: 505737 with stop

Ref. No.: 505739 without stop

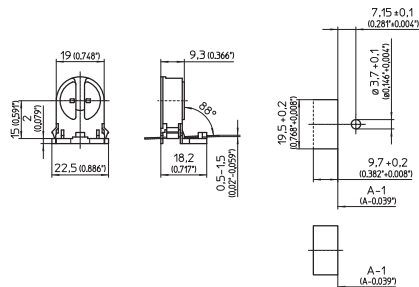

1

2

3

4

5

6

7

8

9

10

8

General Technical Details

General technical details

Product development and product certification	367-368
CE mark	368-370
Climate and environmental protection	370
Protection classes of luminaires and operating devices	371
Operating devices with double or reinforced insulation for installation in protection class II luminaires	371-372
Protection classes of luminaires and operating devices	373
Selection of components, materials and dimensions	374
Impulse voltage categories for lampholders	374
Torque to be applied to screws	374

Glossary

375-377

General Technical Details

The certification of products is also expanded to include non-European manufacturers. However, certification testing for lighting equipment must be carried out by an ENEC testing institute in Europe.

At present, a total of 24 testing houses in 20 countries are signatories of the ENEC agreement (see table). Obtaining an ENEC mark for luminaire components like ballasts and ignitors also includes having the product assessed in accordance with the standards governing safety and function. Certification must be based on the EN standards listed in the Agreement. The mark documents that the product not only complies with the applicable standards, but also that ongoing production is monitored by inspectors from a testing institute and that the manufacturer operates an effective quality assurance system in accordance with the ISO 9000 standard suite (International Standards Organisation). ISO deals with the standardisation of non-electrotechnical products.

The ENEC mark is displayed with the identification number and often the logo of the testing institute, as follows:

Identification No.	Testing Institute	Identification No.	Testing Institute
01	AENOR - Spain	16	SGS Fimko - Finland
02	SGS - Belgium	17	NEMKO - Norway
03	IMQ - Italy	18	TRI MEEI - Hungary
04	CERTIF - Portugal	19	ITCL - United Kingdom
05	DEKRA - Netherlands	21	EZÚ - Czech Republic
08	LCIE - France	22	SIQ - Slovenia
09	MIR-TEC - Greece	23	TSE - Turkey
10	VDE - Germany	24	TR IPTÜV - Germany
11	ÖVE - Austria	25	TÜV SÜD PS - Germany
12	BSI - United Kingdom	28	SEP - BBJ - Poland
13	Electrosuisse - Switzerland	30	PREDOM - OBR - Poland
14	Intertek SEMKO - Sweden		EVPU - Slovakia
15	UL Int'l DEMKO - Denmark		

Apart from a product's safety and performance certification, a further useful selection aid is to have a product's electromagnetic compatibility (EMC) tested by an independent test institute, particularly in the case of electronic ballasts. If the product passes the EMC test, an additional test mark is awarded, for instance the VDE EMC mark of the VDE test and certification institute in Offenbach. The EMC certifications for control gears are helpful for the EMC luminaire certification and could reduce time and cost for the luminaire certification.

CE mark

EC Directives form the basis for a common European domestic market without any trade restrictions. Any products that are destined for the European market have to meet the requirements of all directives that apply to the product in question. Compliance with the directives is documented by the CE mark on the product or in the technical documents.

This CE mark is therefore not a mark of compliance with standards (test certificate) of a testing institute, like the ENEC mark is, and can therefore not be issued by a testing institute. The CE mark must be printed on the product, the packaging or both and is not directed at the consumer, but at supervisory authorities.



The following table contains a list of key EC Directives governing lighting:

2015/1428/EC	Directive dated 25 August 2015 that amends Directive (EC) No. 244/2009 of the Commission with regard to laying down requirements for the eco-friendly design of households lamps with unbundled light and Directive (EC) No. 245/2009 of the Commission with regard to laying down requirements for the eco-friendly design of fluorescent lamps without a built-in ballast, high-pressure discharge lamps as well as ballasts and luminaires for their operation and for annulling Directive 2000/55/EC of the European Parliament and the Committee and Directive (EU) No. 1194/2012 of the Commission with regard to the eco-friendly design of lamps with bundled light, LED lamps and associated devices.
2014/53/EC	Requirements for radio equipment (luminaires with built-in transmitters) dated 16 April 2014 governing the harmonisation of legal regulations on retailing radio equipment on the market and to render Directive 1999/5/EC invalid.
2014/35/EC	Electrical equipment designed for use within certain voltage limits (Low Voltage Directive); valid from 20.04.2016
2014/30/EC	Directive on the harmonisation of the laws of the Member States relating to electromagnetic compatibility; national laws had to take effect by 20.01.2007. Applicable to new products since 20.07.2007. (EMC Directive); valid from 20.04.2016
2012/19/EU	Directive governing the recycling of used electric and electronic devices (WEEE Directive)
2012/27/EU	Energy efficiency directive that amends Directives 2009/125/EC as well as 2010/30/EU and renders Directives 2004/8/EC and 2006/32/EC invalid
1194/2012/EC	Ecodesign requirements for directional lamps, light emitting diode lamps and related equipment
874/2012/EC	Energy labelling of electrical lamps and luminaires
2011/65/EC	Restrictions governing the use of certain hazardous substances in electrical and electronic devices. On 3 January 2015, the 2011/65/EU (RoHS 2) Directive superseded the previous 2002/95/EC (RoHS 1) Directive. Both directives are unofficially shortened to RoHS (Restriction of Hazardous Substances).
347/2010/EC	Ecodesign requirements for fluorescent lamps without an integrated ballast, for high intensity discharge lamps, and for ballasts and luminaires able to operate such lamps
2010/31/EC	Directive governing the total energy efficiency of buildings
2010/30/EC	Indication by labelling and standard product information of the consumption of energy and other resources by energy-related products (this directive supersedes directive 98/11/EC)
859/2009/EC	Ecodesign requirements on ultraviolet radiation of non-directional household lamps
245/2009/EC	Definition of eco-design requirements regarding fluorescent lamps without an integrated ballast, high-pressure discharge lamps as well as ballasts and luminaires in their operation and the invalidation of Directive 2000/55/EC of the European Parliament and Council.
244/2009/EC	Definition of eco-design requirements regarding household lamps with non-directional light.
2009/125/EC	Setting of ecodesign requirements for energy-related products (ErP). This directive supersedes directive 2005/32/EC. The new directive was extended and now includes all energy-consuming products. Regulations 244 and 245 remain unaffected by this change.
1907/2006/EC	Specifications governing the registration, evaluation, authorisation and description of chemicals: REACH (R egistration, E valuation, A uthorisation and R estriction of C hemical Substances) plus amending regulations; e.g. 348/2013/EC, latest amendment of the REACH regulation
2006/95/EC	Electrical equipment designed for use within certain voltage limits (Low Voltage Directive); valid till 19.04.2016
2006/32/EC	Energy end-use efficiency and energy services - ES Directive (Energy Service); national laws must take effect by 17.05.2008.
2006/25/EC	Directive on the minimum health and safety requirements regarding the exposure of workers arising from physical agents (artificial optical radiation)
2005/32/EC	Eco-design requirements for energy-using products - EuP directive (Energy using Products).
2005/20/EC	Directive regarding packaging
2004/108/EC	Directive on the approximation of the laws of the Member States relating to electromagnetic compatibility; national laws had to take effect by 20.01.2007. Applicable to new products since 20.07.2007. (EMC Directive); valid till 19.04.2016
2004/40/EC	Directive on the minimum health and safety requirements regarding the exposure to the risks arising from physical agents (electromagnetic fields)
2004/12/EC	Directive on packaging
2003/66/EC	Directive on energy labelling of household electrical refrigerators, freezers and lamps
2002/96/EC	Old electrical and electronic devices; effective since 13.08.2005; does not fall under the CE mark directive
2002/91/EC	Total energy efficiency of buildings; effective since 04.01.2006; does not fall under the CE mark directive
2001/95/EC	Directive on general product safety
1999/05/EC	Requirements for radio-controlled systems and telecommunications equipment as well as reciprocal acknowledgement of their conformity (R&TTE = Radio Equipment and Telecommunications Terminal Equipment) dated 9 March 1999. Also applies to luminaires with built-in transmitters.
1998/11/EC	Energy rating of household lamps; effective since 14.06.1999
1994/62/EC	Directive on packaging
93/68/EWC	CE marking directive

1

2

3

4

5

6

7

8

9

10

Manufacturers are obliged to keep conformity declarations as well as test and production documentation ready for presentation.

The documents must be retained for a period of 10 years after the product was last marketed.

Vossloh-Schwabe operating devices all bear the CE mark; the respective conformity declaration and production documentation are available for inspection. As a consequence, all luminaires that are equipped with properly installed VS components and for which the assembly instructions were observed meet the legal requirements.

Climate and environmental protection

The European Union adopted a number of EU Directives that are designed to reduce the CO₂ output.

Essentially, these objectives can be grouped into three categories:

- requirements placed on new products,
- requirements placed on buildings and
- revision of existing installations.

The requirements placed on new products are governed by the **ErP framework directive** (**E**nergy-related **P**roducts) together with the so-called implementation directives, which envisage the setting of special energy requirements for lamps (minimum lm/W requirements), operating devices (minimum efficiency ratings) and luminaires (minimum energy efficiency requirements) for all lighting technologies. The directive on energy efficiency requirements regarding ballasts for fluorescent lamps is integrated into the implementation directives.

The requirements for buildings (**EPBD: E**nergy **P**erformance of **B**uildings) specify targets for the maximum permissible primary output of lighting. In so doing, a calculation method is employed that will stipulate the permissible maximum electrical output values of the lighting system using a reference procedure.

With regard to the revision of existing installations the EU member states are called upon to set up national action plans (**Energy Service Directive**) that show which measures can be used to achieve the targeted CO₂ reductions.

In addition to the climate protection requirements, a number of directives were also produced to cover waste reduction and recycling, specifically the **WEEE** (**W**aste of **E**lectrical and **E**lectronic **E**quipment) and **RoHS** (**R**estriction of the use of certain **H**azardous **S**ubstances) directives. These directives regulate the disposal and reduction of waste and the use of hazardous substances.

As a result of the REACH system (**R**egistration, **E**valuation, **A**uthorisation and Restriction of **C**hemical Substances) only registered chemical substances can now be brought onto the market. The principle is: no data, no market.

As operating devices and lampholders are constituent parts of luminaires, these components are to be disposed of along with the luminaire; separate disposal is not provided for.

Protection classes of luminaires and operating devices

The electric shock protection that luminaires and control gears are fitted with provides dual protection, which prevents any danger in the event of a technical defect. With regard to safety, the simultaneous occurrence of two errors can be taken into account in certain circumstances, e.g. given a street luminaire with two lamp casings, one of which is used to house the ballast that operates the lamp. This also applies to low-voltage LED lighting systems.

Luminaires and operating devices of **protection class I** provide protection against electrical shock solely using the base insulation and the safe connection of all exposed conductive parts to an earth conductor. Thus, should the base insulation fail, no exposed conductive parts can become live.

Luminaires and operating devices of **protection class II** provide protection against electrical shock using both the base insulation and an additional or reinforced insulation. Protection class II products do not feature a connection to a protective earth conductor. The mounting conditions do not ensure any additional degree of protection, either.

In special cases with Protection Class II luminaires, it can be permissible to connect a protective conductor or a function protection conductor, as follows:

- **for EMC reasons** – in such cases, it can be necessary to connect a function protection conductor to remain within EMC limiting values. The component manufacturer's specifications regarding the individual operating devices must be observed during the construction of the luminaire. If an operating device is marked as containing a function protection conductor, the creepage and air clearance distances of the operating device connection must comply with the requirements of protection class II (reinforced or additional insulation);
- **as an ignition aid for lamps** – connecting a function protection conductor can be necessary as a capacitive ignition aid for lamps. In such cases the creepage and air clearance distances around the ignition aid within the luminaire and the function protection conductor connection terminal have to comply with the requirements of protection class II (reinforced or additional insulation). The ignition behaviour of a lamp should be agreed with the manufacturer in these cases;
- **when wiring the protective conductor** from the luminaire to another device. This is an installation point of the protective conductor and creepage and air clearances must comply with the respective requirements laid down in the luminaire standard as well as any requirements regarding reinforced or additional insulation.
Functional earth connections of control gear or Protection Class II luminaires must always feature double or reinforced insulation since no technical safety requirements exist for functional earth.

Operating devices with double or reinforced insulation for installation in protection class II luminaires

Protection class II specifications have to be met by the luminaire along with its installed operating device. Both protection class I and class II ballasts can be installed. The design of the luminaire must be adapted to suit. This means that if a protection class I ballast is installed in a protection class II luminaire, the design of the luminaire has to be correspondingly sophisticated to ensure the creepage and air clearance distances can be met. On the other hand, using a protection class II ballast, only available as an independent ballast nowadays, will in most cases result in a need for too much technical effort and thus in high costs. Against this background, the standards contain special requirements for ballasts destined for installation in protection class II luminaires.

These "**double or reinforced insulation ballasts**" and respective protection class II lampholders permit technically and cost-effective construction of protection class II luminaires.



Connection terminal for the protective earth conductor
Protection class I



Connection of the function protection conductor
(will drop in future)



General symbol for an earth connection



Protection class II



Ballasts with double or reinforced insulation



Protection class III

1

2

3

4

5

6

7

8

9

10

Protection class III luminaires provide protection against electrical shock by using Safety Extra Low Voltage (SELV). Luminaires of protection class III are not permitted to generate higher voltages than the Safety Extra Low Voltage (SELV).

The following table (X1), which has been taken from the luminaire standard EN 60598-1, provides an overview of the insulation coordination between the various types of built-in electronic ballasts and the types of insulation found in luminaires.

Operating gear		Necessary insulation between active parts and exposed conductive parts		
Insulation between LV supply and the secondary circuit	Output voltage	Protection class I Insulation of exposed, earthed and conductive parts	Protection class II Insulation of an exposed, conductive part or more as one with potential equalisation	Protection class II Insulation of more than one exposed, conductive part without potential equalisation
None	$U_{OUT} > LV_{Supply}$	Basic insulation suitable for U_{OUT}	Double or reinforced insulation suitable for U_{OUT}	Double or reinforced insulation suitable for U_{OUT}
	$U_{OUT} \leq LV_{Supply}$	Basic insulation suitable for U_{OUT}	Double or reinforced insulation suitable for U_{OUT}	Double or reinforced insulation suitable for LV_{Supply}
Basic	Voltage > ELV	Basic insulation suitable for U_{OUT}	Additional insulation suitable for U_{OUT} plus LV_{Supply}	Insulation must satisfy the higher requirement of a) or b) a) Additional insulation suitable for U_{OUT} plus LV_{Supply} b) Double or reinforced insulation suitable for U_{OUT}
	ELV (FELV)	Basic insulation suitable for U_{OUT}	Additional insulation suitable for U_{OUT} plus LV_{Supply}	Additional insulation suitable for U_{OUT} plus LV_{Supply}
Double or reinforced	Voltage > ELV	Basic insulation suitable for U_{OUT}	Basic insulation suitable for U_{OUT}	Double or reinforced insulation suitable for U_{OUT}
	ELV (SELV)	Basic insulation suitable for U_{OUT}	Basic insulation suitable for U_{OUT}	Basic insulation suitable for U_{OUT}
		also see requirement of IEC 60598-1, sections 8, 10 and 11		

Protection classes of luminaires and operating devices

IEC 60529 (EN 60529) defines protection classes for enclosures of casings. The IP Code (International Protection Code) describes the level of protection provided against accidental contact and penetration by foreign bodies as well as protection against water. The first number stands for protection against foreign bodies, the second stands for protection against water. These specifications are important with particular regard to built-in or mounted luminaires as the provisions governing protection against accidental contact provide the basis for the insulation system for components and conductors (also see luminaire standard EN 60598-1).

To comply with the IP requirements, the installation instructions supplied by the luminaire and/or operating device manufacturer(s) must be observed.

Number	1st Number		2nd Number
	Protection against contact	Protection against foreign bodies	Protection against water
0	No protection	No protection	No protection
1	Protected against contact with the back of the hand	Protected against solid foreign bodies $\varnothing \geq 50$ mm	Protected against vertically dripping water
2	Protected against finger contact	Protected against solid foreign bodies $\varnothing \geq 12$ mm	Protected against diagonally dripping water (angle of 15° from above)
3	Protected against contact with tools	Protected against solid foreign bodies $\varnothing \geq 2.5$ mm	Protected against diagonal water spray up to an angle of 60° from above
4	Protected against contact with wire	Protected against solid foreign bodies $\varnothing \geq 1$ mm	Protected against water splashes from any direction
5	Protected against contact with wire	Protected against dust	Protected against jets of water
6	Protected against contact with wire	Dust-tight	Protected against strong jets of water
7	–	–	Protected against temporary immersion in water
8	–	–	Protected against permanent submersion in water. Specific testing conditions must be agreed, especially with regard to high-pressure cleaning equipment.
9	–	–	For high-pressure cleaning IPx9 in accordance with DIN 4005

If any components like ballasts or conductors of built-in or mounted luminaires (e.g. wall-mounted luminaires) are accessible to accidental contact, they must comply with the requirements of the two safety levels stipulated for these components. Luminaire construction must be in line with these conditions, which can mean that, for instance, conductors have to feature additional or reinforced insulation.

For lampholders the compliance with the two safety levels is proved by conducting a special voltage test.

European standard EN 50102 "Degrees of protection provided by enclosures for electrical equipment against external mechanical impacts (IK code)" introduces an IK code, analogous to the IP degree of protection of electrical control gear, that was also adopted as a national standard in France, e.g. with the French standard NF EN 50102. Testing is carried out using a pendulum hammer that, in accordance with the IK code, must be dropped from a certain height with respective weights attached to exert the specified impact energy. The table details impact energy values for luminaires (IK00 to IK10).

IK Code	Energy Nm or Joule	IK Code	Energy Nm or Joule
IK00	0.0	IK06	1
IK01	0.14	IK07	2
IK02	0.2	IK08	5
IK03	0.35	IK09	10
IK04	0.5	IK10	20
IK05	0.7		

Selection of components, materials and dimensions

The documentation provided by Vossloh-Schwabe is carefully researched. Technical advice is given to the best of our knowledge. The details on the product or the type plate are binding in every case.

Any manipulation of VS products or product packaging is illegal and violates registered trademark rights. Manipulations can negatively influence or destroy technical properties and can possibly result in secondary damage. Vossloh-Schwabe does not accept any liability for manipulated products and cannot be held responsible for any secondary damage.

Manufacturers of luminaires and lighting systems remain responsible for the selection of suitable luminaire components, e.g. operating devices and lampholders, and component materials just as for their safe and correct installation in line with luminaire and system set-up regulations.

Particular attention should be paid to the following:

- temperature measurements and temperature limits
- compliance with creepage and air clearance distances and insulation thicknesses
- selection of components to suit their operating conditions and degree of strain (e.g. voltage, current, mechanical loading, UV radiation)
- protection against contact and safe protective earth conductor connections
- resistance to corrosion

The product drawings without tolerances are contained in this catalogue only feature nominal dimensions. For space and simplicity reasons, the full dimensions and particularly the associated tolerances cannot be shown. For detailed information resp. details of luminaire design, please request our in-depth dimensional assembly drawings.

All VS products comply with the relevant standards and are developed and produced using the latest technological expertise.

To ensure safe luminaire production we do not recommend reusing dismantled lampholders.

Impulse voltage categories for lampholders

Lampholder	Standard	Impulse voltage category
E14: 250 V / 2 A	IEC 60238 / VDE 0616-1	2
E27: 250/500 V / 4 A		2
E40		2
Starters: 250 V / 2 A	IEC 60400 / VDE 0616-3	2
Fluorescent lamps 250 V / 500 V / 2 A	IEC 60400 / VDE 0616-3	2
Halogen lamps and other lamps	IEC 60838-1 / VDE 0616-5	2
Bayonet fitting	IEC 61184 / VDE 0616-2	2

Torques for screws

With regard to lampholders secured with screws, we recommend using a torque of around 80% of the value stipulated in DIN EN 60598-1

Nominal diameter of the screw's outside thread mm	Torque (Nm) for screws with a head in acc. with DIN EN 60598-1
to 2.8	0.40
< 2.8 to 3.0	0.50
< 3.0 to 3.2	0.60
< 3.2 to 3.5	0.80
< 3.6 to 4.1	1.20
< 4.1 to 4.7	1.80
< 4.7 to 5.3	2.00
< 5.3 to 6.0	2.50

A	A type, B type capacitors	The requirements of the safety standard for capacitors differentiates between capacitor types; A type capacitors stand for plastic can capacitors; B type capacitors stand for aluminium can capacitors.
	AG DALI	International working group under the umbrella of ZVEI (the German Electrical and Electronic Manufacturers' Association) in support of DALI (Digital Addressable Lighting Interface).
	Analogue interface 1–10 V	Bipolar interface of dimmable operating devices with a built-in constant current source.
	Average service life	Specified service life of electronic operating devices with a failure rate per unit of time.
B	Ballast	Device that is connected in between the voltage supply and one or more discharge lamps and serves the purpose of igniting the lamps and limiting lamp current during operation.
	Ballast-Lumen Factor (luminous flux factor of a ballast)	The ratio of luminous flux emitted by a reference lamp when operated with a particular production ballast to the luminous flux emitted by the same lamp when operated with its reference ballast.
C	Capacitive circuit (series compensation)	Circuit of an inductive ballast with a capacitor connected in series.
	CE Mark	European regulation governing all products that are introduced to the market. Products must comply with the respective EC directives.
	CELMA	Association of European component and luminaire manufacturers (Committee of E.E.C. Luminaires Components Manufacturers Associations).
	CENELEC	European committee for electronic standardisation (Comité Européen de Normalisation Electrotechnique).
	CISPR	International special commission for radio interference (Comité International Spécial des Perturbations Radioélectriques).
	Colour rendering index (CRI) R_a	Index to determine the degree of deviation from a viewed body colour (with 8 standardised test colours) under a given type of lighting. $R_a = 100$ denotes a light source that causes no distortion of any colour. Lower R_a values denote light sources with less positive colour rendition properties.
	Compensated circuit (parallel compensation)	Circuit of an inductive ballast with a capacitor between phase and neutral conductor.
	Compensation capacitors	The power factor can be increased to a value of 0.9–0.98 by using compensation capacitors.
	Conformity declaration	Documentation for an operating device or a luminaire regarding compliance with European directives; this documentation is for submission to national supervisory authorities (e.g. regulation authority for telecommunications and post (Reg. TP) or trade supervisory authorities).
	Convertors	Electronic convertor (electronic conversion of mains voltage in extra-low voltage) to generate operating voltage for low-voltage halogen lamps.
	Creepage and air clearance distances	Regulation minimum distances between voltage-carrying components of different polarity or between voltage-carrying components and the accessible casing surfaces (air clearance: shortest distance through air; creepage distance: shortest distance across a surface).
	Cross discharge	Discharge in the lamp electrode region during preheating.
D	DALI	Digital interface for controlling dimmable electronic operating devices (Digital Addressable Lighting Interface).
	Δt	Increase in the winding temperature during the operation of a ballast (the ballast is mounted on 75 mm high wooden blocks and its temperature is measured at an ambient temperature of 25 °C).
	Δt_{an}	Temperature increase during short-circuit operation (e.g. defective starter, defective lamp).
	DIAL	German institute for applied lighting technology (Deutsches Institut für Angewandte Lichttechnik, Lüdenscheid, Germany).
	DKE	German electrotechnical commission of the DIN and VDE.
	Driver	Name commonly given to ballasts used for operating LED modules.
E	EC directives	Regulations (laws) of the European Community that have to be transposed into national laws within a prescribed period of time.
	Efficiency	Ratio of power output in relation to power input.
	ELC	European Lamp Companies Federation
	EMC	Electromagnetic compatibility
	EMF	Electromagnetic fields
	ENEC agreement	Agreement between the European testing institutes for issuing the European test mark.
	ENEC mark	Marking for a device that complies with the European standards and that was tested by a testing institute that is a part of the ENEC agreement (European Norms of Electrical Certification).
	Energy classification EEI	CELMA system to determine energy classes for ballasts for fluorescent lamps (Energy Efficiency Index).
	Error current	Current that is caused by a fault in the insulation of a device or via creepage or air clearance distances.
	Error current protection switch	Evaluates the magnitude of the error current and switches the circuit off if a predefined maximum value is reached.
F	Feed-through of mains voltage	The possibility of connecting two lamps to a single terminal so that an electrical connection can be made to another device.
	FELV	Functional extra-low voltage without adequate protection from accidental contact with higher voltages in other parts of the same circuit.
	FEP capacitors	Flame- and explosion-proof capacitors with a contact breaker.
	FGL	Promotion Society for Good Lighting (Fördergemeinschaft Gutes Licht – ZVEI).
	Function protection conductor	It may be necessary to connect a "function protection conductor" to ensure compliance with the EMC requirements or as a starting aid for lamps; VS operating devices are suitably marked.

1

2

3

4

5

6

7

8

9

10

I IDC terminal (ALF terminal)	IDC-type connection terminal (Insulation Displacement Connection) for automatic luminaire fabrication (ALF terminal).
IEC	International Electrotechnical Commission
ILCOS lamp designation system	International IEC marking system for lamps.
Illuminance E_v	Illuminance (E_v) is the total luminous flux (Φ) incident on a horizontal, vertical or angled illuminated surface (per unit area). The unit is lux [$lx=lm/m^2$], with luminous flux in [lm] and area in [m^2]. Illuminance E_v forms the basis for all lighting calculations and designs.
Impedance	Impedance is a conductor's apparent resistance to an alternating current.
IMQ	Italian institute for quality marking; at the same time, the mark of conformity with standards (Istituto Italiano del Marchio di Qualità).
Independent lamp operation	Possibility of operating a single lamp with a multi-lamp operating device after the other lamps have failed.
Independent operating device	Operating device that does not have to be installed in a casing; the safety regulations are fulfilled by the operating device itself.
Inductance	Inductance establishes the connection between the current and the magnetic flux caused by it in a conductor arrangement after taking account of all design and material fluctuations.
Inductive circuit	Operation of a fluorescent lamp with a ballast without a capacitor.
Interference	Interference signals emitted by operating devices via the mains voltage or the air.
Interference immunity	Property of an operating device to remain fully functional despite interference emitted by other operating devices.
IP numbers	Code system for marking the protection level of an operating device or a luminaire against moisture or foreign bodies entering (the first figure stands for foreign bodies and the second for moisture).
IPP technology	Generating the ignition voltage required for high-pressure lamps using the special intelligent pulse pause technology.
L LBS lamp designation System	Marking system for lamps, established for Europe.
Leak current	Current of an operating device or a luminaire that is discharged via the potential compensation conductor (earth conductor).
LED (light emitting diode)	Solid state device embodying a p-n junction, emitting optical radiation when excited by an electric current.
LED light engine	Functional unit consisting of an LED module and control gear. The LED light module and the control gear can be used separately in two different casings or combined as a single unit.
LED module	Unit supplied as a light source. In addition to one or more LED's it may contain other components, e.g. optical, electrical, mechanical and/or electronic.
Light colour	Perceived colour of the light radiated by a lamp.
LightingEurope	An industry association consisting of European lamp, component and luminaire manufacturers as well as national lighting associations in Europe. LightingEurope is the successor organisation of CELMA and ELC (European Lamp Companies). LightingEurope represents the interests of the European lighting industry.
Light intensity distribution curve	Represents the spatial distribution of the light intensity of light sources.
LiTG	German Association for Lighting Technology (Deutsche Lichttechnische Gesellschaft)
Luminance L	Luminance L is the luminous intensity density of an area that emits or reflects light with a certain emission angle. The unit of luminance L is [cd/m^2] and is the photo-technical measure that corresponds to the subjective perception of the level of brightness of a light source or an object, while luminous flux Φ , luminous intensity I and illuminance E are not visible, i.e. not sensed by the human eye. Light only becomes visible when it hits an object that it is either reflected by or penetrates in a diffused manner. Objects of different levels of brightness therefore only seem to be darker or brighter at same illuminance because they reflect the light differently.
Luminous efficiency / efficiency	Ratio of luminous flux to power input (lm/W).
Luminous flux Φ (photon radiation)	Luminous flux Φ is the radiated/emitted light power in lumen [lm] of a light source, a unit of measurement for the number of light photons emitted in all directions. Luminous flux is the photometrical light output perceived by the human eye.
Luminous intensity I	Luminous intensity I in [cd] is decisive for characterising of a source of light and is defined as a quotient of the emitted luminous flux Φ and the radiated area of the solid angle Ω . Luminous intensity I is thus the focused luminous flux Φ within the radiated solid angle Ω . Today's LEDs can reach a luminous intensity of more than $I=10$ cd. The luminous intensity value depends on the viewing angle, i.e. the luminous intensity of an LED chip in a 30° reflector will be higher than that of an identical LED chip in a 60° reflector. This is because a 60° reflector results in the same luminous flux Φ having to illuminate a larger area.
M Mains harmonics	Mains current distortions by higher-frequency currents.
Master/slave circuit	Operating several lamps in different luminaires with one ballast.
μF	Unit of capacitance (microfarad)
MPP capacitors	Metallised polypropylene film dielectric capacitors.
P Parallel-compensated circuits	Circuit of an inductive ballast with a capacitor between phase and neutral conductor (connected in parallel to the lamp circuit).
Part load range	Variable load range up to the maximum rated load.
PELV	Protective extra-low voltage with adequate protection from accidental contact with higher voltages in other parts of the same circuit.
Phase-cutting leading-edge control	In accordance with the defined angle, voltage regions are suppressed of the positive and negative sinusoidal oscillations of the mains voltage in an upwards direction starting with the voltage zero crossing.
Pinch temperature	This is measured at a defined point of the lamp base; the permissible maximum values are internationally determined.
Polyester resin impregnation	High-grade vacuum impregnation with polyester resin.
Power factor	Ratio of true power to apparent power (total power). Lambda (λ) expresses the power factor for non-sinusoidal currents and voltages. In contrast, $\cos \phi$ (ϕ) expresses the power factor for sinusoidal currents or voltages.
Pulse Ignition	Generation of the ignition voltage for high-pressure lamps with the help of ballasts (ballast insulation must match the ignition voltage).
PUSH	Key-operated bipolar interface of VS electronic ballasts for controlling the brightness of connected lamps.

R Reference ballast	Special ballast that is either inductive for lamps operated with mains voltage or ohmic for lamps operated at high frequencies. Reference ballasts are designed to deliver comparable values for testing ballasts, selecting reference lamps and testing mass-produced lamps under standardised conditions.
Reference lamp	When used in combination with a suitable reference ballast, reference lamps provide key electrical data that are close to the target values laid down in the lamp standards.
S Safety transformer	Isolation transformer for supplying circuits with safety extra-low voltages.
SELV	Safety extra-low voltage.
Short-circuit-proof	Short-circuit-proof operating devices do not pose a safety risk if a short-circuit occurs at the output of the operating device; a difference is made between operating devices offering limited and unlimited protection against short-circuit; in the case of operating devices with limited short-circuit protection, an additional mechanism has to be installed.
Solid angle Ω	Solid angle Ω is the area within a sphere that is pervaded by the light emitted by a light source. The steradian (sr) is the unit of measure for solid angle, whereby $1 \text{ sr} = 65.5^\circ$. This describes a cone with its peak in the light source and a beam spread angle of 65.5° . A whole solid angle is expressed as $4\pi \text{ sr} = 12.56 \text{ sr}$.
Standards	VS products comply with the regulations of the following European standards: <ul style="list-style-type: none"> • Electronic ballasts for fluorescent lamps: EN 61347-1, EN 61347-2-3, EN 60929, EN 55015, EN 61547, EN 61000-3-2, IEC 62493 • Electronic ballasts for high-pressure discharge lamps: EN 61347-1, EN 61347-2-12, EN 55015, EN 61547, EN 61000-3-2, IEC 62493 • Electronic convertors: EN 61347-1, EN 61347-2-2, EN 61047, EN 55015, EN 61547, EN 61000-3-2, IEC 62493 • Electromagnetic ballasts: EN 61347-1, EN 61347-2-8, EN 61347-2-9, EN 60921, EN 60923, EN 50294, EN 55015, EN 61547, EN 61000-3-2, IEC 62493 • Electromagnetic transformers: EN 61558-1, EN 61558-2-6, EN 55015, EN 61547, EN 61000-3-2, IEC 62493 • Ignitors: EN 61347-1, EN 61347-2, EN 60927, EN 55015, EN 61547, EN 61000-3-2 • Capacitors: EN 61048, EN 61049 • Lampholders: EN 60238, EN 60400, EN 60838-1, EN 61184, EN 60399 • Digital control inputs of operating devices: IEC 62386 • LED: IEC 62031, IEC 61347-1, IEC 61347-2-13, IEC 62384, IEC 61231, IEC TR 61341, IEC 60838-2-2, IEC 62471(-1), EC 62471-2 • EMC/EMF: EN 55015, EN 61547, EN 61000-3-2, IEC 62493
Stroboscopic effect	Optical illusion whereby objects appear either to be moving or stationary in contrast to their actual state when illuminated by periodically alternating light.
Superimposed ignition	Generation of the ignition voltage required for high-pressure lamps by the ignitor independent of the ballast (superimposed over the mains voltage).
System power consumption	Total power input of lamp and operating device (in watt).
T t_a	Ambient temperature
TALQ	Industrial consortium for the globally recognised standardisation of a management software interface for outdoor lighting networks. The aim is to enable the interoperability of central management systems and outdoor lighting networks made by different manufacturers.
Tandem circuit	Series connection of two fluorescent lamps using a single ballast.
t_c	Maximum operating temperature of the casing at the marked measuring point.
Temperature details	The temperature details on our VS ballasts are always maximum values; these are based on the maximum voltage values given on the type plate.
The Connected Lighting Alliance	Industrial consortium that was founded by GE Lighting, Lutron, OSRAM, Panasonic, Philips, Toshiba in August 2012 for the purpose of supporting global use and distribution of wireless connectivity in lighting applications.
Thermal classes	Classification of transformers according to the degree of heat resistance offered by the insulation materials.
Thermal cut-out	Protection from overheating due to abnormal lamp conditions (rectifier effect, short-circuit and overload), with automatic restart after cooling.
Transient mains overvoltages	Voltage peaks that briefly occur and are superimposed over the mains voltage.
T rating	Rated value of the lampholder's maximum operating temperature (e.g. T130).
Tungsten-halogen cycle	In the outer, cooler part of the lamp, the halogen combines with the tungsten vapour released by the filament to form a tungsten-halogen molecule which then decomposes and deposits the tungsten on the filament.
t_w	Maximum permissible winding temperature.
U UL, UL approval	Underwriters' Laboratories Inc., USA; US conformity mark for safety.
V VDE mark	Safety mark on the basis of the German safety standard for electrical equipment; tested by the VDE-PZI (Verband Deutscher Elektrotechniker - Prüf- und Zertifizierungsinstitut).
W Winding temperature	Temperature of the copper winding in a magnetic ballast; the change in winding temperature is measured using the change of the resistance of the copper winding.
Z Zhaga	Global industrial consortium that has taken on the task of standardising the interfaces needed for LED light engines.
ZVEI	Central association of the electrotechnical and electronics industry in Germany (Zentralverband Elektrotechnik- und Elektronik-industrie e.V.).

1

2

3

4

5

6

7

8





















9

10

Reference Numbers

Ref. No.	Type	Page	Approval
100064	02120	218	1,3
100069	02150	218	1,3,33
100082	02525	81	1
100086	02543	81	1
100096	02574	80	1
100098	02575	81	1
100125	03210	326	–
100194	06700	326	–
100217	07400	327	–
100270	08610	326	–
100273	08701	326	–
100305	09105	186	1,3
100310	09205	186	1,3
100437	20200	225	1
100442	20400	206	–
100444	20401	206	–
100448	20501	206	–
100484	22600	200	1,3,33
100486	22601	200	1,3,33
100487	22602	200	1,3,33
100551	27356	205	1,3
100557	27450	198	1,3,33
100559	27460	198	1,3
100572	27722	205	1,3
100579	27820	195	1,3,33
100581	27821	195	1,3
100583	27822	205	1,3
100585	28100	198	1,3,33
100588	28200	198	1,3,33
100591	28500	196	1,3,33
100593	28501	196	1,3,33
100616	30023	293	1
100662	30300	285	1
100710	30523	293	1
100720	30550	293	1
100723	30602	80	1
100741	30620	80	1
100912	32300	291	1
100913	32301	78	1
100921	32311	78	1
100922	32321	78	1
100925	32326	79	1
100928	32330	79	1
100931	32336	79	1
100932	32341	78	1
100934	32361	78	1
100937	32381	79	1
100939	32400	279, 282, 284	1
101162	32600	283	1
101207	32620	283	1
101258	32700	279	1
101274	32720	279	1
101298	35004	173	1,3,33
101306	35006	173	1,3,33
101310	35007	173	1,3,33
101314	35008	173	1,3
101320	35010	174	1,3,33
101324	35011	174	1,3,33
101344	35051	174	1,3,33
101346	35052	174	1,3
101358	35100	175	1,3
101364	35201	175	1,3,33
101485	36050	177	1,3,33
101489	36051	177, 361	1,3,33
101491	36052	178	1,3,33
101493	36053	178	1,3,33
101497	36061	181	–
101521	36300	176	1,3
101528	40100	214	1,3
101532	40150	214	–





















Ref. No.	Type	Page	Approval
101627	43000	219	1,3,33
101629	43010	219	1,3
101631	43100	219	1,3
101636	43300	220	1,3,33
101643	46100	204	1,3
101647	46101	204	1,3
101651	46102	205	1,3
101655	46103	205	1,3
101681	47102	202	1,3
101706	47200	202	1,3
101708	47202	202	1,3
101712	47205	203	1,3
101716	47206	203	1,3
101740	47502	202	1,3
101745	47504	203	1,3,33
101765	47600	202	1,3
101769	47605	203	1,3,33
101773	47606	203	1,3
101781	47700	203	1,3
101784	47900	204	1,3,33
101785	47920	204	1,33
101787	48500	204	1,3
101789	48501	204	1,3
101791	48502	206	1,3
101793	48503	206	1,3
102407	58001	214	–
102409	58016	214	1
102577	62010	67, 317	1
102582	62015	67, 317	1
102599	62050	67, 317	1
102615	62104	67	1
102617	62105	67	1
102624	62310	68, 318	1
102635	62600	66	1
102637	62601	66	1
102923	78100	286	1,3
102925	78101	286	1,3
102938	80003	306	–
102939	80003	306	–
102946	80006	306	–
102947	80006	306	–
102956	80014	322	–
103020	80342	319	–
103021	80342	319	–
103026	80343	319	–
103027	80343	319	–
103087	80433	327	–
103359	81019	306	–
103360	81019	306	–
103365	81022	306	–
103366	81022	306	–
103414	81093	304	–
103415	81093	304	–
103424	81095	303	1,33
103430	81109	304	–
103431	81109	304	–
103442	81120	304	–
103443	81120	304	–
103467	83000	314	–
103468	83000	314	–
103483	83002	314	–
103484	83002	314	–
103504	83006	321	1
103515	83008	321	1
103520	83011	314	1,33
103569	83173	314	–
103570	83173	314	–
103582	83218	319	–
103583	83218	319	–
103587	83218	322	–

- 1  ENEC
1a applied
- 2  15 D
- 3  C UL US
- 5  CSV
- 7  KEMA
- 13  KEMA KEUR
- 13a  KEMA EMC
- 14  VDE
14a applied
- 15  VDE
- 16  TUV
TUV Approved
Safety
Product
Quality
Management
System
- 17  S
- 19  PGT
- 25  B
- 28  EMC
- 31  RAM  S
- 32  SABS
- 33  CQC
- 34  RU US
- 35  EUL
RECOGNIZED
COMPONENT
US
- 36  DEKRA

Reference Numbers

Ref. No.	Type	Page	Approval
103590	83219	319	–
103591	83219	319	–
103594	83219	322	–
103595	83221	319	1
103597	83223	319	1
103643	83285	314	1,33
103709	84122	213	–
103710	84122	213	–
103711	84123	213	–
103712	84123	213	–
103743	84154	213	–
103744	84154	213	–
103749	84159	213	–
103750	84159	213	–
103818	86037	81	–
104928	94304	320, 321	–
105144	96010	320, 321	–
105179	96033	320	–
105185	96034	320	–
105448	97031	179	–
105482	97064	221	–
105483	97065	221	–
105484	97065	221	–
105775	35060	179, 180	–
105776	35060	179	–
105777	35760	180	–
105824	97516	179	–
105843	97532	206	–
105845	97533	207	–
105847	97534	207	–
105931	35061	179, 180	–
105981	97638	180	–
106094	98085	212	–
106095	98086	221	–
106248	32800	281	1,34
106249	32820	281	1,34
106416	35060	179	–
106417	35760	180	–
106455	09210	186	1,3
106457	32480	283	1
106513	78201	286	1,34
106583	78201	286	1,34
106585	62110	67	1
106766	94067	327	–
106767	94068	327	–
106768	94069	327	–
106802	94074	327	–
106817	98006	324	–
106818	02170	219	1,3
106829	94450	328	–
106893	35814	168	1,3
106948	09501	330	–
106949	09502	330	–
107065	31662	77	1
107066	31672	77	1
107096	83015	322	1
107154	05202	326	–
107177	96242	312	–
107178	96206	312	–
107192	32360	292	1
107193	32340	292	1
107194	32320	292	1
107195	32310	292	1
107213	32390	291	1
107214	32391	291	1
107215	32395	291	1
107331	83015	322	1
107445	43410	221	1
107617	35844	168	1,3
107618	35864	168	1,3

Ref. No.	Type	Page	Approval
107677	21100	82	34
107694	33100	285	–
107716	81096	303	1,33
107780	12800	69, 332	1
107861	35914	168	1,3
107957	84171	209	1
107958	84172	210	1,3
107959	84173	209	1
107960	84174	210	1,3
108208	12800	69, 332	1
108257	31936	361	–
108266	98003	192, 207, 209	–
108267	98004	192, 210	–
108304	97159	329	–
108373	12812	70, 332	1
108374	12810	70, 332	1
108375	12810	70, 332	1
108416	62622	67	1
108437	28920	199	1,3
108438	28921	199	1,3
108449	30471	281	1
108454	43500	220	1
108575	35944	168	1,3
108576	35964	168	1,3
108608	84175	210	1,3
108614	84175	210	1,3
108666	84172	210	1,3
108669	84174	210	1,3
108671	43020	219	1,3
108678	94071	282	–
108718	62150	66	1
108719	62151	66	1
108730	48230	198	1
108747	64740	309	1,33
108748	64800	324	1
108758	64741	309	1,33
108773	22800	200	1
108775	22801	200	1
108777	22850	200	1
108778	22851	200	1
108780	97044	207	–
108816	22604	200	1,3,33
108819	22852	211	1
108845	97117	208	–
108878	36060	181	–
108898	35012	174	1,3,33
108927	35500	175	1,3
108928	35510	175	1,3
108932	35530	176	1,3
108933	35540	176	1,3
108934	35550	176	1,3
108936	64401	307	1,33
108937	02500	80	1
108940	85007	294	–
108947	98002	192, 211	–
108948	84180	211	1
108953	64770	309	1,33
108956	97194	328	–
108965	64501	308	1,33
108979	31000	289	1,34
108983	64307	299	1,33
108984	22900	200	1
108994	84181	211	1
109007	31010	289	1,34
109014	12870	360	–
109039	83007	315	–
109041	81130	305	–
109044	96172	316	–
109045	97511	311	–
109052	83007	315	–





















1	
	ENEC
1a	applied
2	
3	
5	
7	
13	
13a	
14	
	VDE
14a	applied
15	
16	
17	
19	
25	
28	
31	
32	
33	
34	
35	
36	

1
2
3
4
5
6
7
8
9
10

Reference Numbers

Ref. No.	Type	Page	Approval
109054	81130	305	–
109060	96172	316	–
109062	97511	311	–
109074	83293	315	–
109077	85070	310	–
109081	83274	316	–
109084	96159	305	–
109086	97147	207	–
109087	83293	315	–
109092	85070	310	–
109093	83274	316	–
109095	96159	305	–
109098	83035	315	–
109099	83035	315	–
109102	81002	304	–
109103	81002	304	–
109110	85075	300	–
109112	85075	300	–
109119	97666	301	–
109120	97666	301	–
109122	97635	301	–
109123	97635	301	–
109126	97697	301	–
109145	81024	304	–
109149	96211	305	–
109150	96211	305	–
109152	81132	305	–
109153	81132	305	–
109158	83297	323	1
109159	83282	312	–
109162	03210	326	–
109166	05202	326	–
109184	97698	311	–
109187	96148	315	–
109188	96148	315	–
109190	96154	316	–
109191	96154	316	–
109195	96147	315	–
109196	96147	315	–
109198	83260	322	–
109199	83260	322	–
109200	96229	323	–
109201	96229	323	–
109235	35610	172	1,3
109238	35611	172	1,3
109240	35612	172	1,3
109243	83300	323	–
109247	09708	329	–
109248	09701	330	–
109249	09703	329	–
109253	09701	330	–
109280	96033	320	–
109281	96034	320	–
109282	83258	321	–
109283	83258	321	–
109285	08610	326	–
109291	08701	326	–
109317	96160	330, 331	17
109318	96160	330, 331	17
109330	27700	194	1,3,33
109331	27701	194	1,3,33
109332	27800	194	1,3
109335	27801	194	1,3
109338	28500	195	1,3,33
109339	28501	195	1,3,33
109340	28600	195	1,3,33
109341	28601	195	1,3,33
109342	28700	363	–
109343	28701	363	–
109376	28725	363	–





















Ref. No.	Type	Page	Approval
109377	28726	363	–
109383	64001	298	1,33
109384	64001	298	1,33
109386	64101	298	1,33
109387	64101	298	1,33
109411	97244	289	–
109429	64501	308	1,33
109462	83282	312	–
109497	32380	292	1
109512	96124	316	–
109518	12876	360	–
109532	84000	193	–
109547	33300	278, 282, 284	1,34
109548	97255	278	–
109550	97257	278, 287	–
109553	94095	282	–
109554	94096	284	–
109555	97260	312	–
109556	97260	312	–
109559	96124	316	–
109560	97698	311	–
109568	62111	67	1
109575	97065	221	–
109592	09705	330	–
109600	09704	331	–
109621	94435	327	–
109622	94436	327	–
109674	33400	278	1,34
109676	97636	300	–
109677	97636	300	–
109679	97665	310	–
109680	97665	310	–
109685	94088	190	–
109686	09170	190	1,3
109725	97750	328	–
109728	97752	328	–
109784	02110	218	1,3,33
109790	43200	220	1,3
109792	43210	220	1,3,33
109794	97664	311	–
109795	97664	311	–
109805	81024	304	–
109838	64770	309	1,33
140413	Z 70 S	44	1,14
140425	Z 250 S	45	1,14
140427	Z 400 S	46	1,14
140430	Z 1000 S	49	1,14
140432	Z 2000 S	52	–
140471	Z 1000 L	50	–
140481	Z 70 K	44	1,14
140489	Z 250 K	45	1,14
140496	Z 1000 S/400 V	50	14
140497	Z 2000 S/400 V	52	14
140499	Z 3500 S/400 V	52	–
140537	CE 50	62	–
140594	Z 400 M	47	1,14
140597	Z 400 M K	47	1,14
140607	Z 1000 TOP	49	14
140608	Z 1200/2,5	51	–
140609	Z 1200/9	51	–
140613	PZS 1000 K	54	14
140617	PZI 1000/1 K	54	14
140621	PU 12 K	57	14
140622	PU 120 K	57	14
140623	PU 121 K	57	–
140627	AS 1000 K	60	1,14
140693	Z 400 M S	47	1,14
141193	AS 1000 KA10	61	–
141580	Z 70 K D20	44	1,14
141581	Z 250 K D20	45	1,14

- 1  ENEC
1a applied
- 2  UL US
- 3  UL US
- 5  CSV
- 7  KEMA
- 13  KEMA
- 13a  EMC
- 14  VDE
14a applied
- 15  VDE
- 16  Safety logo
- 17  S
- 19  PGT
- 25  B
- 28  EMC
- 31  RAM
- 32  SABS
- 33  CQC
- 34  UL US
- 35  EUL
- 36  DEKRA

Reference Numbers

Ref. No.	Type	Page	Approval
141582	Z 400 M K D20	47	1,14
141583	Z 400 S D20	46	1,14
141584	Z 1000 S D20	49	1,14
142098	ZPU 70 K D20	58	14
142099	ZPU 250 K D20	58	14
142150	PR 12 K D	57	14
142170	PR 12 K LC	57	14
142320	Z 70 K	44	1,14
142330	Z 70 K D20	44	1,14
142340	Z 250 K	45	1,14
142350	Z 250 K D20	45	1,14
142360	Z 400 M K	47	1,14
142361	Z 400 M K VS-Power	47	14
142370	Z 400 M K D20	47	1,14
142783	PZ 1000/400 V A5	53	14
142784	PZ 1000 K D20	53	14
142897	Z 400 M K VS-Power	47	14
146990	Z 750 S	48	14
147230	SP 230/10 K	13	14
147707	Z 400 M VS-Power	47	14
147790	HZ 600 K	55	-
147791	HZ 1000 K	56	-
147793	HZ 2000 K/400 V	56	-
149992	SU 1-10 V K	59	14
149993	PR 1-10 V K LC	59	14
159968	O607	208	-
160597	NaHJ 250.160	22	1,19,31
160604	NaHJ 250.163	22	-
160613	NaHJ 70/50.157	21	1
161158	NaHJ 100/70.519	22	1
161367	NaHJ 35.485	21	1
161371	NaHJ 35.638	21	-
161379	NaH 50.486	21	1
161392	NaHJ 70.653	21	-
161399	NaH 50.654	21	-
161460	UNaH 70/40%.691	37	-
161469	NaHJ 100/70.703	22	1
161471	NaHJ 100/70.709	22, 37	-
161475	UNaH 150/40%.717	37	-
161662	NaHJ 70.158	21	1
161686	NaHJ 250.915	22	1,31,32
161707	NaHJ 100.941	22	1
161757	STr 50/12.301	273	15,19
161781	STr 20/12.306	273	19
161860	STr 20/12.306	274	19
161935	STr 105/12.406	274	-
163256	L 20.122	158, 163	34
163305	L 7/9/11.207	154	-
163318	L 7/9.209	158	34
163683	L 4/6/8.304	160	1,19,25
163694	L 7/9/11.307	154	1,19,25,31
163702	L 15.308	163	34,35
163711	LN 13.313	154, 160	1,19,25,31
163730	LN 16.316	154, 161	1,25
163763	LN 181.319	155	1,19,25,31
163861	LN 15.329	161	1,25
164013	L 25.346	161	1
164033	L 30.347	161	19,25,31
164326	L 4/6/8.404	160	1
164335	L 7/9/11.411	154	1
164342	LN 13.413	154, 160	1
164353	LN 181.418	156	1
164358	LN 16.417	154, 162	1
164438	L 36/40.443	156, 162	1
164555	LN 36.505	156, 162	1
164560	LN 58.506	156, 162	1
164566	LN 18.507	156, 162	1
164572	LN 18.510	155, 161	1
164590	LN 36.511	155, 161	1
164680	LN 30.530	155	-

Ref. No.	Type	Page	Approval
164779	L 181.602	157	-
164828	L 58.625	157, 162	-
164870	L 58.657	157, 162	-
167100	Q 50.501	32	1
167125	Q 50.508	32	1
167132	Q 80.510	32	1
167136	Q 125/80.511	32	1
167140	Q 125.512	32	1
167144	Q 250.513	32	1,19,31
167185	Q 50.535	32	-
167213	Q 50.550	32	1,32
167250	Q 400.561	32	1,19,31
167263	Q 125.568	32	1,19,31,32
167299	Q 80.584	32	-
167302	Q 80.587	32	19
167304	Q 80.588	32	1,19,31,32
167306	Q 80/50.592	32	-
167311	Q 80/50.596	32	1
167326	Q 125/80.611	32	1
167330	Q 400.612	32	1,19,31,32
167335	Q 400.613	32	-
167367	Q 250.528	32	1,19,31,32
167374	Q 400.669	32	1
169125	STr 105/12.406	273	-
169389	LN 58.568	155, 161	1
169645	LN 30.801	161	1
169647	LN 13.805	154	1
169658	L 58.718	155, 161	1
169721	NaHJ 150.995	24	1,32
169722	NaHJ 70.158	24	1,32
169747	STr 105/12.311	274	19,31
169748	STr 50/12.401	274	-
169779	LN 36.570	155, 161	1
169830	STr 50/12.401	273	-
169892	UNaH 250/40%.983	37	-
169947	Q 125.549	32	1,19
170002	STr 105/12.311	273	15,19,31
170091	STr 50/12.301	274	14,19
170117	L 14.139	163	-
172775	Cover plate	150	-
172776	Light sensor	150	-
172777	Multi sensor	150	-
172778	Manual controller	150	-
174961	NaHJ 70.300	21	1,31
178177	NaHJ 250.340	22	1
178771	NaHJ 250.727	29	1,19,32
178790	NaHJ 400.006	29	1,31,32
179424	NaHJ 400.737	29	1,19,31,32
179444	STr 50/12.337	274	-
179454	NaH 600.005	29	1,19
179604	STr 60/12.338	273	-
179608	STr 60/12.338	274	-
179740	NaHJ 400.006	29	1,31,19
179742	NaH 600.010	29	1
179743	NaHJ 250.003	29	1
183000	EHXc 100.353	12	1,14,28
183001	EHXc 100.353	12	1,14,28
183028	EHXc 50.358	9	1,14,28
183029	EHXc 50.358	9	1,14,28
183030	EHXc 50.358	9	1,14,28
183033	EHXc 35.325	9	1,14,28
183034	EHXc 35.325	9	1,14,28
183035	EHXc 35.325	9	1,14,28
183036	EHXc 70.326	9	1,14,28
183037	EHXc 70.326	9	1,14,28
183038	EHXc 70.326	9	1,14,28
183039	ELXc 424.223	143	1,14,28
183040	ELXc 226.878	133	1,14,28
183046	EHXc 150G.334	12	1,14,28
183047	EHXc 150G.334	12	1,14,28





















1	
	ENEC 1a applied
2	
3	
5	
7	
13	
13a	
14	
	VDE 14a applied
15	
16	
17	
19	
25	
28	
31	
32	
33	
34	
35	
36	

1
2
3
4
5
6
7
8
9
10

Reference Numbers

Ref. No.	Type	Page	Approval
183059	ELXd 235.735	148	1,14,28
183094	ELXc 328.224	143	1,2
183108	ELXc 226.878	133	1,14,28
183109	ELXc 414.227	145	16
183110	ELXc 424.228	145	16
183111	ELXc 228.229	145	16
183112	ELXc 328.230	145	16
183113	ELXc 135.231	145	16
183114	ELXc 235.232	145	16
183115	ELXc 239.233	145	16
183116	ELXc 149.234	145	16
183117	ELXc 249.235	145	16
183118	ELXc 254.236	145	16
183119	ELXc 180.237	145	16
183122	ELXc 114.238	146	16
183123	ELXc 128.239	146	16
183124	ELXc 214.240	146	16
183125	ELXc 228.241	146	16
183126	ELXc 414.242	146	16
183127	ELXc 118.243	146	16
183128	ELXc 136.244	146	16
183129	ELXc 158.245	146	16
183130	ELXc 218.246	146	16
183131	ELXc 236.247	146	16
183132	ELXc 258.248	146	16
183133	ELXc 418.249	146	16
183134	ELXc 118.879	135	16
183135	ELXc 126.880	135	16
183136	ELXc 218.881	135	16
183137	ELXc 226.882	135	16
186072	EST 70/12.380	272	1,14,28
186077	EST 105/12.381	272	1,14,28
186098	EST 150/12.622	272	1,14,28
186173	EST 60/12.635	272	13
188080	Cord Grip	10	-
188093	ELXc 135.856	143	1,14,28
188094	ELXc 235.857	143	1,14,28
188095	ELXc 149.858	143	1,14,28
188140	ELXc 140.862	126, 143	1,14,28
188142	ELXc 154.864	143	1,14,28
188144	ELXc 180.866	126, 143	1,14,28
188329	ELXd 124.600	128, 149	1,14,28
188330	ELXd 224.601	128, 149	1,14,28
188331	ELXd 139.602	128, 149	1,14,28
188332	ELXd 154.603	128, 149	1,14,28
188333	ELXd 254.604	128, 149	1,14,28
188334	ELXd 180.605	131, 149	1,14,28
188335	ELXd 249.606	149	1,14,28
188336	ELXd 124.607	128, 148	1,14,28
188337	ELXd 224.608	128, 148	1,14,28
188338	ELXd 139.609	128, 148	1,14,28
188339	ELXd 239.610	128, 148	1,14,28
188340	ELXd 154.611	128, 148	1,14,28
188341	ELXd 254.612	128, 148	1,14,28
188342	ELXd 180.613	128, 148	1,14,28
188343	ELXd 249.614	148	1,14,28
188350	ELXd 239.621	128, 149	1,14,28
188400	ELXc 257.836	133, 134	1,14,28
188431	ELXd 226.801	140	14,28
188438	ELXc 414.868	143	1,14,28
188490	ELXd 226.801	140	14,28
188549	ELXd 218.803	140	1,14,28
188550	ELXd 242.807	140	1,14,28
188564	ELXd 118.802	140	1,14,28
188565	ELXd 142.806	140	1,14,28
188589	ELXc 128.869	131, 132	1,14,28
188590	ELXc 128.869	133, 134	1,14,28
188595	ELXc 336.214	143	1,14,28
188597	ELXd 324.623	128, 148	1,14,28
188598	ELXd 424.624	128, 148	1,14,28





















Ref. No.	Type	Page	Approval
188600	ELXd 324.626	128, 149	1,14,28
188602	ELXd 424.628	128, 149	1,14,28
188604	ELXd 280.630	148	1,14,28
188605	ELXd 280.631	149	1,14,28
188616	ELXc 240.863	126, 143	1,14,28
188617	ELXc 249.859	143	1,14,28
188618	ELXc 254.865	126, 143	1,14,28
188619	ELXc 280.538	126, 143	1,14,28
188643	ELXc 242.837	131, 132	1,14,28
188680	ELXc 155.378	132	1,14,28
188681	ELXc 155.378	134	1,14,28
188687	ELXc 242.837	133, 134	1,14,28
188694	ELXd 118.802	140	1,14,28
188695	ELXd 142.806	140	1,14,28
188696	ELXd 218.803	140	1,14,28
188697	ELXd 242.807	140	1,14,28
188698	ELXc 213.870	131	1,14,28
188699	ELXc 218.871	131	1,14,28
188700	ELXc 142.872	131, 132	1,14,28
188704	ELXc 136.207	144	14
188705	ELXc 236.208	144	14
188706	ELXc 158.209	144	14
188707	ELXc 258.210	144	14
188713	ELXc 218.871	133	1,14,28
188714	ELXc 142.872	133, 134	1,14,28
188717	ELXd 135.823	148	1,14,28
188744	ELXc 418.204	143	1,14,28
188792	EMXs 180.000	349	-
188793	EMXs 180.001	349	-
188794	EMXs 180.002	349	-
188795	EMXs 180.003	349	-
188823	EMXs 180.000	349	-
188824	EMXs 180.001	349	-
188825	EMXs 180.002	349	-
188826	EMXs 180.003	349	-
188827	Battery Holder	349	-
188828	Battery Holder	349	-
188829	Battery Holder	349	-
188864	ELXd 117.715	141	1,14,28
188865	ELXd 117.715	141	1,14,28
188866	ELXd 217.717	141	1,14,28
188867	ELXd 217.717	141	1,14,28
188873	ELXd 118.718	128, 148	1,14,28
188874	ELXd 218.719	128, 148	1,14,28
188875	ELXd 136.720	128, 148	1,14,28
188876	ELXd 236.721	128, 148	1,14,28
188877	ELXd 158.722	128, 148	1,14,28
188878	ELXd 258.723	148	1,14,28
188886	ELXc 213.874	136	1,14,28
188887	ELXc 218.875	136	1,14,28
188888	ELXc 142.876	136, 137	1,14,28
188889	ELXc 242.877	136, 137	1,14,28
188912	ELXc 136.216	144	1,14,28
188913	ELXc 236.217	144	1,14,28
188914	ELXc 158.218	144	1,14,28
188915	ELXc 258.219	144	1,14,28
188922	ELXc 235.221	144	14,28
188923	ELXd 142.709	141	1,14,28
188924	ELXd 142.709	141	1,14,28
188932	ELXd 135.724	149	1,14,28
188933	ELXd 235.725	149	1,14,28
188952	ELXd 118.705	141	1,14,28
188953	ELXd 118.705	141	1,14
188954	ELXd 218.707	141	1,14,28
188955	ELXd 218.707	141	1,14
188974	ELXd 242.711	141	1,14,28
188975	ELXd 242.711	141	1,14
188993	EHXc 35G.327 B		1,14,28
188994	EHXc 35G.327 I	8	1,14,28
400548	32020		1

- 1  ENEC
1a applied
- 2  ¹⁵ D
- 3  C UL US
- 5  CSV
- 7  KEMA
- 13  KEMA
- 13a  EMC
- 14  VDE
14a applied
- 15  VDE
- 16  Safety Protection
- 17  S
- 19  PGT
- 25  B
- 28  EMC
- 31  RAM
- 32  SABS
- 33  CQC
- 34  C UL US
- 35  RECOGNIZED COMPONENT
- 36  DEKRA

Reference Numbers

Ref. No.	Type	Page	Approval
400671	94066	327	-
400699	80474	327	-
400732	97755	329	-
400772	80476	328	-
400779	80475	328	-
400817	85076	300	-
400818	85076	300	-
400819	85077	311	-
400820	85077	311	-
400913	12600	69	1
400914	12600	69	1
400915	12610	69	1
400916	12610	69	1
400917	12614	69	1
400918	12614	69	1
401536	94444	328	-
401549	94438	328	-
401970	97754	329	-
500106	36011	178	1
500296	Capacitor	258	1
500299	Capacitor	258	1
500300	Capacitor	258	1
500301	Capacitor	258	1
500302	Capacitor	258	1
500303	Capacitor	258	1
500304	Capacitor	258	1
500305	Capacitor	258	1
500315	Capacitor	258	1
500316	Capacitor	258	1
500317	Capacitor	258	1
500318	Capacitor	258	1
500319	Capacitor	258	1
500320	Capacitor	258	1
500321	Capacitor	258	1
500322	Capacitor	258	1
500323	Capacitor	258	-
500401	NaHJ 250.011	29	-
500402	NaHJ 400.737	29	1
500403	NaHJ 400.012	29	1
500574	35613	172	1,3
500757	84001	190, 193	-
500810	64401	307	1,33
500843	STr 50/12.207	273	-
500969	NaHJ 250.727	29	1,19
500976	NaHJ 250.727	29	1,19
501351	08400	321	-
501352	08400	321	-
501356	64601	308	1,33
501358	64601	308	1,33
501533	09145	187	1
501534	09146	187	1
501942	97268	288	-
502004	33500	288	1,34
502064	97320	289	-
502111	31020	289	1,34
502112	31030	289	1,34
502394	33600	71	1
502416	97282	290	-
502503	05202	288	-
502515	83301	324	-
502592	STr 50/12.422	273	-
502783	Capacitor	258	1
502799	NaHJ 100.941	24	1
502818	Q 125.598	32	-
503010	NaHJ 35.485	24	1,32
503041	64781	309	1,33
503136	NaHJ 70/50.695	38	1
503457	97000	301	5
503458	97000	301	5
503579	97322	299	-

Ref. No.	Type	Page	Approval
503773	98087	192, 212	-
503923	64201	298	1,33
503924	64201	298	1,33
504078	98011	192, 210	-
504109	NaHJ 250.340	22	-
504131	NaHJ 100/70.703	24, 38	1
504135	NaHJ 150/100.973	24, 38	1
504202	28315	198	1
504302	64719	308	1,33
504303	64719	308	1,33
504351	Capacitor	258	1
504416	31695	77	1
504467	Q 250.417	34	1,32
504474	Q 400.001	34	1,32
504615	97321	310	-
504640	83226	319	-
504641	83226	319	-
504643	83227	319	-
504644	83227	319	-
504669	31696	77	1
504749	96021	324	-
504769	83283	312	-
504938	97277	182	-
504939	97278	182	-
505002	Q 400.001	34	1
505014	64770	66	1
505029	31980	76	1
505030	31981	76	1
505054	NaHJ 250.915	24	1,31,32
505251	93088	295	-
505389	64770	66	1,33
505720	64719	66	1
505721	64719	66	1,33
505732	09404	187, 191	1,3
505733	09405	187	1,3,33
505734	09406	187	1,3,33
505735	09415	188	1,3,33
505736	09416	188	1,3,33
505737	09420	188, 364	1,3,33
505739	09421	188, 364	1,3
505745	09426	189	1,3,33
505746	09427	189	1,3,33
505747	09440	189	1,3
505750	09450	189	1,3,33
505751	09460	190	1,3,33
505782	J 400.027	29	1
505951	83310	288	-
506007	28310	198	1,33
506020	09607	331	17
506024	09607	331	17
506026	09606	330	17
506027	09606	330	17
506120	NaHJ 100.670	23	1,19
506122	NaHJ 35.485	23	1,32
506211	94079	327	-
506247	64360	299	1,33
506249	64360	299	1,33
506255	64775	308	1,33
506257	64775	308	1,33
506263	64785	308	1,33
506265	64785	308	1,33
506267	64785	308	1,33
506366	Capacitor	258	1
506495	Capacitor	258	1
507049	81018	306	-
507050	81018	306	-
507052	81017	306	-
507053	81017	306	-
507075	83283	312	-
507105	34000	281	1





















1	
	ENEC 1a applied
2	
3	
5	
7	
13	
13a	
14	
	VDE 14a applied
15	
16	
17	
19	
25	
28	
31	
32	
33	
34	
35	
36	

1
2
3
4
5
6
7
8
9
10

Reference Numbers

Ref. No.	Type	Page	Approval
507133	48205	203	1
507134	48206	203	1
507181	STr 50/12.342	273	-
507256	Q 250.703	32	1
507341	NaHJ 70/50.157	23	1
507342	NaHJ 100/70.703	23	1
507343	NaHJ 150/100.973	23	1
507490	97257	278, 287	-
507498	NaH 50.486	24	1
507562	97677	191	-
507592	97528	79, 293	-
507593	97528	79	-
507627	UNaH 150/100.722	38	1
507656	41900	76	1
507671	NaHJ 100.126	22	1,19
507697	NaHJ 70/50.695	24	1
507797	97267	329	-
507798	97267	329	-
507802	83146	320	1
507803	83147	320	1
507936	LN 58.192	156, 162	1
508067	97037	302	5
508186	LN 58.116	155, 161	1
508245	Q 400.613	32	-
508352	96004	305	-
508353	96004	305	-
508423	28330	199	1
508468	Capacitor	258	1
508484	Capacitor	259	1
508562	97355	295	15
508563	97356	295	-
508590	09407	188	1,3
508667	Capacitor	258	1
508668	Capacitor	258	1
508723	NaHJ 250.340	24	1
508741	NaHJ 400.012	29	1
508744	NaHJ 250.011	29	-
508746	Q 250.417	34	1
508922	LN 181.940	155	1
509100	NaHJ 150.355	23	1,19,31
509110	93034	288	-
509117	34301	77	1
509118	93035	288	-
509152	47105	201	1,3,33
509154	47106	201	1,3,33
509156	47304	201	1,3,33
509162	47505	201	1,3,33
509164	47506	201	1,3,33
509169	NaHJ 70.653	23	-
509170	NaHJ 35.638	23	-
509171	NaHJ 150.679	23	-
509213	42000	75	1,3
509214	42100	76	1,3
509263	64307	299	1,33
509295	97355	295	15
509296	97356	295	15
509340	97427	302	17
509349	LN 58.990	155, 161	1
509356	31400	74	1,34
509357	33800	286	1,34
509373	L 36.120	157, 162	-
509490	NaHJZ 70/50.785	27	15
509491	NaHJZ 100/70.786	27	15
509492	NaHJZ 150/100.787	27	15
509502	LN 26.813	155	1,31
509519	93059	180	-
509520	93058	180	-
509521	93057	180	-
509522	93056	180	-
509613	J 400.027	29	1





















Ref. No.	Type	Page	Approval
520733	97705	300	-
520734	97705	300	-
520735	85074	300	-
520736	85074	300	-
520759	97708	301	-
520760	97708	301	-
520865	30470	281	1,34
520880	94455	287	-
520882	94457	287	-
520992	L 13.210	154, 160	-
521010	80280	287	-
521123	84105	212	1,3
525583	97760	287	-
525791	STr 50/12.109	273	-
526019	27780	196	1
526020	27781	196	1
526021	28580	196	1
526022	28581	196	1
526169	Capacitor	259	1
526170	Capacitor	259	1
526171	Capacitor	259	1
526196	NaHJ 150.679	22	-
526211	31936	361	-
526517	NaHJ 35.485	21	1
526616	NaHJ 150.679	24	-
526715	Q 1000.311	34	-
526886	97497	310	17
527191	LN 36.130	155, 161	1
527196	LN 36.201	156, 162	1
527502	71001	167	1,3,33
527503	71002	167	1,3,33
527504	71003	167	1,3,33
527506	71011	167	1,3,33
527507	71012	167	1,3,33
527508	71013	167	1,3,33
527509	71014	167	1,3,33
527510	71015	167	1,3
527511	71016	167	1,3
527512	71019	167	1,3,33
527529	71101	167	1,3,33
527530	71102	167	1,3,33
527531	71103	167	1,3,33
527533	71111	167	1,3,33
527534	71112	167	1,3,33
527535	71113	167	1,3,33
527536	71114	167	1,3,33
527537	71115	167	1,3
527538	71116	167	1,3
527539	71119	167	1,3,33
527556	71201	170	1,3,33
527557	71202	170	1,3,33
527558	71203	170	1,3,33
527560	71211	170	1,3,33
527561	71212	170	1,3,33
527562	71213	170	1,3,33
527563	71214	170	1,3,33
527564	71215	170	1,3
527565	71216	170	1,3
527566	71219	170	1,3,33
527585	71301	168	1,3,33
527586	71302	168	1,3,33
527587	71303	168	1,3,33
527589	71311	168	1,3,33
527590	71312	168	1,3,33
527591	71313	168	1,3,33
527592	71314	168	1,3,33
527594	71315	168	1,3
527595	71316	168	1,3
527596	71319	168	1,3,33
527735	71501	166	1,3,33

- 1  ENEC
1a applied
- 2  15 D
- 3  C UL US
- 5  CSV
- 7 
- 13 
- 13a 
- 14  VDE
14a applied
- 15 
- 16  TUV
TUV Approved Safety Products
TUV Rheinland
TUV SUD
- 17 
- 19 
- 25 
- 28  EMC
- 31  RAM 
- 32 
- 33 
- 34  RU US
- 35  EUL
RECOGNIZED COMPONENT
- 36 

Reference Numbers

Ref. No.	Type	Page	Approval
527736	71502	166	1,3,33
527737	71503	166	1,3,33
527739	71511	166	1,3,33
527740	71512	166	1,3,33
527741	71513	166	1,3,33
527742	71514	166	1,3,33
527743	71515	166	1,3
527744	71516	166	1,3
527745	71519	166	1,3,33
527762	71601	170	1,3,33
527763	71602	170	1,3,33
527764	71603	170	1,3,33
527766	71611	170	1,3,33
527768	71612	170	1,3,33
527769	71613	170	1,3,33
527770	71614	170	1,3,33
527771	71615	170	1,3
527772	71616	170	1,3
527773	71619	170	1,3,33
527790	71701	169	1,3,33
527791	71702	169	1,3,33
527792	71703	169	1,3,33
527794	71711	169	1,3,33
527795	71712	169	1,3,33
527796	71713	169	1,3,33
527797	71714	169	1,3,33
527798	71715	169	1,3
527799	71716	169	1,3
527800	71719	169	1,3,33
528029	71801	169	1,3,33
528030	71802	169	1,3,33
528031	71803	169	1,3,33
528033	71811	169	1,3,33
528034	71812	169	1,3,33
528035	71813	169	1,3,33
528036	71814	169	1,3,33
528037	71815	169	1,3
528038	71816	169	1,3
528039	71819	169	1,3,33
528116	72101	171, 362	1,3,33
528117	72102	171, 362	1,3,33
528118	72103	171, 362	1,3,33
528120	72111	171, 362	1,3,33
528121	72112	171, 362	1,3,33
528122	72113	171, 362	1,3,33
528123	72114	171, 362	1,3,33
528124	72115	171, 362	1,3
528125	72116	171, 362	1,3
528126	72119	171, 362	1,3,33
528128	72111	362	-
528129	72112	362	-
528130	72113	362	-
528131	72114	362	-
528132	72115	362	-
528133	72116	362	-
528134	72119	362	-
528236	Q 400.616	32	1,19
528252	12900	70	15
528253	12910	70	15
528254	12911	70	15
528521	Q 700.035	34	-
528536	NaHJ 1000.089	30	1
528548	NaHJ 1000.089	30	1
528554	Capacitor	259	1
528555	Capacitor	259	1
528582	L 18.121	157, 162	1
528761	Q 1000.096	34	1
528886	Q 1000.145	34	1
528958	12901	70	15
529029	LN 36.149	155, 161	1

Ref. No.	Type	Page	Approval
529072	NaHJ 250.163	22	-
529087	NaHJ 250.204	22	1,19
529464	97498	310	-
529560	NaH 600.140	29	-
529599	64740	309	1,33
529665	Capacitor	259	1
529666	Capacitor	259	1
529832	84101	191	1,3
529836	84103	192	-
529841	34311	77	1
529845	34326	77	1
530024	30400	279	1
530025	30450	280	1
530026	30460	280	1
530027	30465	280	1
530079	43520	220	1
530195	NaHJ 100.271	22	-
530252	L 36.158	157, 162	14
530535	84104	192	1,3
530878	11000	182	1,3,33
530879	11010	182	1,3,33
530941	LN 18.131	155, 161	1
531472	VNaHJ 1000.61	17	-
531474	VJD 2000.63	17	-
531475	VNaHJ 400PZT.743	16	-
531476	VNaHJ 250PZT.745	16	-
531480	VNaHJ 1000.61	17	-
531481	VJD 2000.63	17	-
532149	L 18.121	157, 162	1
532155	LN 2x18.135	155, 161	1
532377	09420	186	1,3
532378	09421	186	1,3
532379	09422	187	1,3
532380	09423	187	1,3
532390	97545	311	-
532391	80023	311	-
532430	13010	82	0
532431	13010	82	0
532521	97685	71	-
532602	12801	69, 332	1
532603	12801	69, 332	1
532604	12811	70, 332	1
532605	12811	70, 332	1
532606	12812	70, 332	1
532610	33906	287	1
532644	L 4/6/8.218	160	-
532687	36051	361	-
533043	LN 18.162	156, 162	1
533067	LN 30.806	162	-
533312	41500	222	1
533313	41510	222	1
533314	41520	222	1
533315	41540	222	1
533316	41550	222	1
533317	41560	222	1
533391	VNaHJ 35PZTG.050	15	1
533392	VNaHJ 70PZTG.051	15	1
533393	VNaHJ 100PZTG.078	15	-
533394	VNaHJ 150PZTG.052	15	1
533395	NaHJZ 70/50.520	26, 39	1
533396	NaHJZ 100/70.519	26, 39	1
533398	NaHJZ 150/100.466	26, 39	1
533428	12601	69	1
533429	12601	69	1
533430	12611	69	1
533431	12611	69	1
533432	12612	69	1
533484	NaH 600.005	29	1,19
533565	NaHJ 150.620	22	1
533568	NaHJ 70.128	21	1





















1	
	ENEC 1a applied
2	
3	
5	
7	
13	
13a	
14	
	VDE 14a applied
15	
16	
17	
19	
25	
28	
31	
32	
33	
34	
35	
36	

1
2
3
4
5
6
7
8
9
10

Reference Numbers

Ref. No.	Type	Page	Approval
533572	NaHJ 70.128	23	1
533602	NaHJ 150.159	22	1,19
533650	LN 75.170	162	1
533663	37001	75	1
533705	Q 250.606	32	-
533820	64308	299	1,33
533947	UNaH 100/40%.452	37	-
533948	UNaH 150/40%.453	37	-
533949	UNaH 250/40%.454	37	-
533957	34510	72	1
534016	34110	73	1
534017	34111	73	1
534073	84108	192	1,3
534080	34105	73	1
534081	34106	73	1
534087	97658	303, 313	17
534088	97701	303, 313	-
534089	97692	303	17
534090	97700	313	17
534097	97632	329	17
534107	VNaHJ 35PZTG.053	15	1
534109	VNaHJ 70PZTG.054	15	1
534111	VNaHJ 70PZTG.067	15	-
534115	VNaHJ 150PZTG.055	15	1
534117	VNaHJ 150PZTG.068	15	-
534122	VNaHJ 35PZTG.041	15	-
534128	UNaH 70/40%.501	37	-
534218	34515	360	-
534219	34516	360	-
534220	34511	72	1
534252	LN 58.722	156, 162	1
534487	NaHJ 1000.089	30	1
534490	LN 24/26.804	155	1
534540	NaHJ 150.620	22	1
534621	L 18.934	155, 161	-
534624	L18.933	157, 162	-
534627	L 18.936	156, 162	-
534644	09900	187	1
534689	98013	326	-
534832	62063	318	1
534833	62063	318	1
534948	41530	222	1
534954	41570	222	1
535032	31705	290	1
535034	31755	290	1
535131	02113	218	1
535142	NaHJ 400.743	28	1
535146	30800	280	1
535191	NaHJ 70.128	23	1
535216	NaHJ 150.620	23	1
535247	97742	318, 325	-
535263	30800	280	1
535267	95300	280	-
535333	UNaH 150/40%.142	37	-
535347	UNaH 100/40%.522	37	-
535348	UNaH 70/40%.525	37	-
535357	91522	302	-
535474	97734	222	17
535657	VNaHJ 70PZTG.566	14	1
535673	64900	325	-
535674	64940	325	-
535684	62061	318	1
535685	62061	318	1
535694	80010	318, 325	-
535695	VNaHJ 150PZTG.567	14	1
535750	42200	75	1
535751	42210	75	1
535755	42222	75	1
535778	LN 2x18.135	156, 162	1
535783	34525	360	-





















Ref. No.	Type	Page	Approval
535977	L 36.132	155, 161	14
535988	30485	281	1
536140	NaHJ 1000.089	30	1
536142	NaHJ 400.743	28	1
536143	NaHJ 400.743	28	1
536144	NaHJ 400.744	28	-
536145	NaHJ 400.743	28	1
536146	NaHJ 400.743	28	1
536147	NaHJ 250.741	28	1
536148	NaHJ 250.741	28	1
536149	NaHJ 250.741	28	1
536150	NaHJ 250.742	28	-
536151	NaHJ 250.741	28	1
536152	NaHJ 250.741	28	1
536164	97765	290	-
536199	VNaHJ 35PZTG.568	14	1
536200	VNaHJ 100PZTG.571	14	-
536201	VNaHJ 35PZTG.568	14	1
536202	VNaHJ 70PZTG.566	14	1
536203	VNaHJ 100PZTG.571	14	-
536204	VNaHJ 150PZTG.567	14	1
536205	VNaHJ 35PZTG.574	14	-
536207	VNaHJ 70PZTG.575	14	-
536209	VNaHJ 150PZTG.576	14	-
536220	12612	69	1
536258	Q 400.801	33	1
536259	Q 400.801	33	1
536260	Q 250.800	33	1
536261	Q 250.800	33	1
536378	Capacitor	257	1
536379	Capacitor	257	1
536380	Capacitor	257	1
536381	Capacitor	257	1
536382	Capacitor	257	1
536383	Capacitor	257	1
536384	Capacitor	257	1
536385	Capacitor	257	1
536386	Capacitor	257	1
536387	Capacitor	257	1
536388	Capacitor	257	1
536389	Capacitor	257	1
536390	Capacitor	257	1
536391	Capacitor	257	1
536392	Capacitor	257	1
536393	Capacitor	257	1
536394	Capacitor	257	1
536395	Capacitor	257	1
536396	Capacitor	257	1
536397	Capacitor	257	1
536398	Capacitor	257	1
536399	Capacitor	257	1
536400	Capacitor	257	1
536401	Capacitor	257	1
536402	Capacitor	257	1
536403	Capacitor	257	1
536404	Capacitor	257	1
536405	Capacitor	257	1
536406	Capacitor	258	-
536428	34150	73	1
536429	34151	73	1
536445	97735	318, 325	-
536446	97735	318, 325	-
536451	62062	318	1
536452	62062	318	1
536469	31500	74	1
536582	NaHJ 70.128	24	1
536593	NaHJ 150.620	24	1
536741	Capacitor	259	1
536742	Capacitor	259	1
536743	Capacitor	259	1

- 1  ENEC
1a applied
- 2  UL D
- 3  UL US
- 5  CSV
- 7  KEMA
- 13  KEMA
- 13a  EMC
- 14  VDE
14a applied
- 15  VDE
- 16  EMC
- 17  S
- 19  PGT
- 25  B
- 28  EMC
- 31  RAM
- 32  SABS
- 33  CQC
- 34  UL US
- 35  EMC
- 36  DEKRA

Reference Numbers

Ref. No.	Type	Page	Approval
536813	Capacitor	259	1
537079	81100	307	–
537080	81100	307	–
537087	83141	307	1
537088	83141	307	1
537103	Q 1000.097	34	19
537132	24100	197	1,3
537135	24110	197	1,3
537138	24120	197	1,3
537144	24150	197	1,3
537147	24160	197	1,3
537150	24170	197	1,3
537153	24350	197	1,3
537155	24360	197	1,3
537157	23350	197	1,3
537160	23360	197	1,3
537165	49100	202	1,3
537166	49105	202	1,3
537173	49500	202	1,3
537174	49505	202	1,3
537175	49506	202	1,3
537181	59100	202	1,3
537182	59105	203	1,3
537183	59106	203	1,3
537205	59500	202	1,3
537206	59505	203	1,3
537207	59506	203	1,3
537403	STr 50/12.109	274	–
537703	Q 400.801	33	1
537726	NaHj 250.741	28	1
537744	L 15.007	162	–
537750	L 30.006	162	–
537763	NaHj 150.620	24	1
537793	NaHj 150.679	22	–
537869	Q 400.715	33	–
537873	Q 400.732	33	–
538034	Q 400.801	33	1
538072	L 361.342	161	1
538089	09700	329	–
538189	NaHj 70.128	25	1
538204	NaHj 400.743	28	1
538258	NaHj 35.485	25	1
538262	NaHj 150.620	25	1
538264	NaHj 150.620	25	1
538361	NaHj 70/50.520	23	1
538407	NaHj 70.128	21	1
538537	NaHj 70.653	25	–
538540	Q 1000.096	34	1
538543	NaHj 150.620	23	1
538592	UNaH 400/40%.892	40	–
538620	NaHj 400.744	28	–
538675	PKNaHj 70.128	19	–
538676	PKNaHj 100.941	19	–
538677	PKNaHj 150.620	19	–
538678	PKNaHj 250.741	20	–
538679	PKNaHj 400.743	20	–
538680	PKNaHj 70.653	19	–
538681	PKNaHj 100.271	19	–
538682	PKNaHj 150.679	19	–
538683	PKNaHj 250.742	20	–
538684	PKNaHj 400.744	20	–
538685	PKNaHj 70.128	19	–
538686	PKNaHj 100.941	19	–
538687	PKNaHj 150.620	19	–
538688	PKNaHj 250.741	20	–
538689	PKNaHj 400.743	20	–
538690	PRKUNaH 70/40%.525	35	–
538691	PRKUNaH 100/40%.522	35	–
538692	PRKUNaH 150/40%.142	35	–
538693	PRKUNaH 250/40%.936	36	–

Ref. No.	Type	Page	Approval
538694	PRKUNaH 400/40%.906	36	–
538695	PRKUNaH 70/40%.525	35	–
538696	PRKUNaH 100/40%.522	35	–
538697	PRKUNaH 150/40%.142	35	–
538698	PRKUNaH 250/40%.936	36	–
538699	PRKUNaH 400/40%.906	36	–
538700	PRKUNaH 70/40%.525	35	–
538701	PRKUNaH 100/40%.522	35	–
538702	PRKUNaH 150/40%.142	35	–
538703	PRKUNaH 250/40%.983	36	–
538704	PRKUNaH 400/40%.937	36	–
538705	PRKUNaH 70/40%.525	35	–
538706	PRKUNaH 100/40%.522	35	–
538707	PRKUNaH 150/40%.142	35	–
538708	PRKUNaH 250/40%.983	36	–
538709	PRKUNaH 400/40%.937	36	–
538710	UNaH 400/40%.906	40	1
538711	UNaH 250/40%.936	40	1
538715	UNaH 400/40%.937	40	–
538801	L 18.249	157, 162	14
538807	NaHj 35.485	25	1
538810	NaHj 70.128	25	1
538823	NaHj 70.128	25	1
538828	NaHj 70.653	25	–
538830	NaHj 70.128	24	1
538831	NaHj 150.620	24	1
538834	NaHj 150.620	25	1
538843	NaHj 150.625	25	1
539050	UNaH 150/100.722	38	1
539081	NaHj 100.581	25	1
539128	23370	197	1,3
539209	NaHj 400.743	28	1
539212	NaHj 1000.089	30	1
539223	NaHj 70.128	25	1
539270	NaHj 150.355	24	1,19,31
539274	NaHj 250.741	28	1
539283	UNaH 250/40%.746	40	–
539286	NaHj 150.620	25	1
539306	NaHj 150.620	25	1
539311	NaHj 150.679	25	–
539328	PRKUNaH 70/40%.525	35	–
539329	PRKUNaH 70/40%.525	35	–
539330	PRKUNaH 100/40%.522	35	–
539331	PRKUNaH 100/40%.522	35	–
539332	PRKUNaH 150/40%.142	35	–
539333	PRKUNaH 150/40%.142	35	–
539334	PRKUNaH 250/40%.936	36	–
539335	PRKUNaH 400/40%.906	36	–
539336	PRKUNaH 250/40%.936	36	–
539337	PRKUNaH 400/40%.906	36	–
539384	UNaH 600/40%.060	40	–
539434	NaHj 70.128	21	1
539492	NaHj 100.941	23	1
539497	34520	72	1
539515	NaH 50/35.797	24, 38	1
539517	UNaH 250/40%.747	40	–
539609	NaHZ 50/35.797	26	1
542349	NaHj 250.340	24	1
542557	NaHj 150.679	25	–
542983	28740	195	1
542984	28741	195	1
543048	85011	294	–
543049	85012	294	–
543053	85013	294	–
543054	85012	294	–
543058	85015	294	–
543059	85016	294	–
543153	31550	361	–
543267	31530	74	1
543295	PKNaHj 100.345	19	–





















1	
	ENEC
1a	applied
2	
3	
5	
7	
13	
13a	
14	
	VDE
14a	applied
15	
16	
17	
19	
25	
28	
31	
32	
33	
34	
35	
36	

1
2
3
4
5
6
7
8
9
10

Reference Numbers

Ref. No.	Type	Page	Approval
543299	PKNaHJ 150.301	19	–
543303	62370	68, 318	1
543304	62070	68, 317	1
543349	NaHJ 100.941	24	1
543378	PKNaH 50PZT.992	19	–
543384	PRKUNaH 70/40%.525	35	–
543385	PRKUNaH 150/40%.142	35	–
543386	PRKUNaH 250/40%.936	36	–
543388	PRKUNaH 100/40%.522	35	–
543389	PRKUNaH 400/40%.906	36	–
543401	PKNaHJ 35.008	19	–
543414	62415	68, 317	1
543615	97765	290	–
543640	09701	330	–
543641	09701	330	–
543643	42242	75	1
543733	VNaH 50PZTG.058	15	–
543737	NaHJ 35.209	23	1
543738	NaH 50.206	23	1
543740	NaHJ 150.216	28	1
543741	NaHJ 70.226	23	1
543742	PRKUNaH 70/40%.525	35	–
543743	PRKUNaH 100/40%.522	35	–
543744	PRKUNaH 150/40%.142	35	–
543745	PRKUNaH 250/40%.936	36	–
543746	PRKUNaH 400/40%.906	36	–
543747	UNaH 250/40%.936	40	1
543748	UNaH 400/40%.906	40	1
543770	40560	224	1
543771	40561	224	1
543772	40562	224	1
543773	40563	224	1
543777	40566	224	1
543778	40567	224	1
543781	40570	224	1
543782	40571	224	1
543783	40572	224	1
543784	40573	224	1
543787	40576	224	1
543788	40577	224	1
543793	40660	223	1
543794	40661	223	1
543795	40662	223	1
543796	40663	223	1
543800	40666	223	1
543801	40667	223	1
543802	40670	223	7
543803	40671	223	7
543805	40672	223	7
543806	40673	223	7
543809	40676	223	7
543810	40677	223	7
543986	NaHJ 400.743	28	1
544210	NaHJ 250.741	28	1
544605	62009	67, 317	1
544621	64800	324	–
544728	UNaH 70/40%.525	38	–
544729	UNaH 150/40%.142	38	–
544730	UNaH 100/40%.522	38	–
544760	PRKUNaH 50/40%.021	35	–
544787	NaHJ 1000.089	30	1
545261	22860	201	1
545262	22861	201	1
545405	LN 26.238	156	1
545840	29100	363	–
545842	29101	363	–
545845	29125	363	–
545849	29126	363	–
545894	09446	189	1,3
545896	09447	189	1,3

Ref. No.	Type	Page	Approval
545933	09432	188, 364	1,3
545935	09433	188, 364	1,3
545937	09434	188, 364	1,3
545939	09435	188, 364	1,3
546004	83013	314	1,33
546006	97745	302	–
546254	98008	192, 211	–
546454	64370	298	1,33
546456	64370	298	1,33
546585	PRKUNaH 250/40%.758	36	–
546609	36020	177	1
546612	36021	177	1
546641	27700 R	194	1,3
546642	27701 R	194	1,3
546647	27800 R	194	1,3
546648	27801 R	194	1,3
546655	58100	193	1,3
546656	58110	193	1,3
546797	PKNaHJ 35.008	19	–
546817	NaHJ 70.158	24	–
547145	LN 21.293	156	–
547285	PKNaHJ 35.008	19	–
547287	PKNaHJ 70.653	19	–
547393	64770	313	–
547394	64770	313	–
547807	34650	71	1,34
547808	34651	71	1,34
548259	NaHJ 400.743	28	1
548260	NaHJ 150.159	25	1,19
549999	31500	74	1
550375	83142	306	1
551271	26300	195, 363	1a,3
551272	26310	195, 363	1a,3
551275	26302	363	–
551277	26312	363	–
551645	Capacitor	257	–
552774	Capacitor	259	1
553806	NaHZ 50/35.797	27	–
554005	NaHJ 100.213	23	1
554270	JD 2000.81	31	–
554283	JD 2000.83	31	–
554303	J 2000.71	31	–
554304	J 2000.72	31	–
554305	J 2000.73	31	–
554306	JD 2000.82	31	–
554307	JD 2000.91	31	–
554308	JD 2000.92	31	–
554309	JD 2000.85	31	–
554310	JD 2000.86	31	–
554311	J 1200.95	31	–
554312	J 2500.96	31	–
554313	VNaHJ 1000.75	18	–
554314	VJ 2000.76	18	–
554315	VJD 2000.77	18	–
554316	VJD 2000.78	18	–
554325	STr 200/12.40	275	–
554326	STr 300/12.41	275	–
554542	33650	71	1
554543	33671	71	1
554662	31760	290	1
554904	VNaHJ 1000.75	18	–
554905	VJ 2000.76	18	–
554906	VJD 2000.77	18	–
554909	VJD 2000.78	18	–
560657	LNN 18.645	159	–
560659	LNN 18.646	159	–
560661	LNN 18.647	159	–
560664	LNN 18.648	159	–
560665	LNN 58TD.649	159	–

1	
	ENEC
1a	applied
2	
3	
5	
7	
13	
13a	
14	
	VDE
14a	applied
15	
16	
17	
19	
25	
28	
31	
32	
33	
34	
35	
36	

Subsidiaries

Subsidiaries	Address	Phone / Fax / Email
Vossloh-Schwabe Deutschland GmbH Germany, Benelux, CIS, Georgia, Great Britain, Ireland, Austria, Switzerland, Scandinavia, Turkey, Ukraine	P.O. Box 28 69 D-58478 Lüdenscheid, Germany	Phone: +49/(0)2351/10 10 Fax: +49/(0)2351/10 12 17 info.vsv@vsv.vossloh-schwabe.com
Australia Vossloh-Schwabe Deutschland GmbH	Branch Office Sydney Unit 4C, 6 Boundary Road Northmead, NSW, 2152, Australia	Phone: +61/(0)2/88 43 07 00 Fax: +61/(0)2/88 43 07 77 sales-us@vsaus.vossloh-schwabe.com
China Vossloh-Schwabe Electrical Appliances Trading (Shanghai) Co., Ltd.	Wiselogic International Center Room 2603, #66 North Shannxi Road Shanghai, P.C. 200041/China	Phone: +86/21/62 18 55 99 Fax: +86/21/62 67 07 81 linda.li@vshk.vossloh-schwabe.com
Czech Republic, Slovakia Vossloh-Schwabe Deutschland GmbH	Sales Office East Europe Na Radosii 184 155 21 Prague 5 - Zlicin, Czech Republic	Phone: +420/235 30 03 58 Fax: +420/235 31 22 61 magdalena.ragauerova@vsv.vossloh-schwabe.com
France Vossloh-Schwabe Deutschland GmbH	Branch Office France 10 Rue Denis Papin CS50101 68025 Colmar, France	Phone: +33/(0)389/20 12 12 Fax: +33/(0)389/24 18 65 vsf.ventes@vsf.vossloh-schwabe.com
Hong Kong Vossloh-Schwabe Hong Kong Ltd.	Flat A & B, 26/F., West Gate Tower 7 Wing Hong Street, Cheung Sha Wan Kowloon, Hong Kong	Phone: +852/28779688 Fax: +852/28779933 linda.li@vshk.vossloh-schwabe.com
Italy Vossloh-Schwabe Italia S.p.A.	Via Strada S. Martino 15 47027 Sarsina/Farli-Cesena, Italy	Phone: +39/0547/9 81 11 Fax: +39/0547/9 82 60 vs-i@vsi.vossloh-schwabe.com
Korea Vossloh-Schwabe Korea	#605 Cosmo Tower Building 416 Youngdongdae-ro, Gangnam-gu Seoul 135-549, Korea	Phone: +82/2/34 84 66 11/16 Fax: +82/2/34 84 66 17 j.y.maeng@vs.vossloh-schwabe.com
New Zealand Vossloh-Schwabe Deutschland GmbH	Branch Office Auckland P.O. Box 58809 2163 Botany, Manukau / New Zealand	Phone: +64/(0)9/265 11 10 Fax: +64/(0)9/265 11 20 sales-nz@vsnz.vossloh-schwabe.com
Poland, Baltic States Vossloh-Schwabe Deutschland GmbH	Sales Office Poland ul. Zaporoska 6/5 PL 30-389 Kraków, Poland	Phone: +48/(0)12/3 57 23 23 Fax: +48/(0)12/2 62 03 26 lukasz.niemczycki@vsv.vossloh-schwabe.com
Serbia, Albania, Bosnia-Herzegovina, Bulgaria, Croatia, Greece, Kosovo, Macedonia, Montenegro, Slovenia, Cyprus Vossloh-Schwabe Deutschland GmbH	Sales Office Belgrad/Serbia Danila Lekica 1 11000 Belgrade, Serbia	Phone: +381/63/286 330 Fax: +381/63/286 330 goran.stankovic@vsv.vossloh-schwabe.com
Singapore Vossloh-Schwabe Pte. Ltd.	Vertex, 33 Ubi Avenue 3 Lobby A #06-72 Singapore 408868	Phone: +65/62 75 75 33 Fax: +65/62 75 76 33 sales.vsf@vsfe.vossloh-schwabe.com
South Africa Vossloh-Schwabe Deutschland GmbH	Branch Office Johannesburg 154, Lechwe Avenue, Corporate Park Midrand 1685, South Africa	Phone: +27/11/31 44 340 Fax: +27/11/31 45 287 barry.hall@vsaf.vossloh-schwabe.com
Spain, South America, Portugal Vossloh-Schwabe Ibérica, S.L.	Venezuela 105, 5º - A 08019 Barcelona, Spain	Phone: +34/93/481 70 70 Fax: +34/93/481 70 71 vs-e@vse.vossloh-schwabe.com
Taiwan Vossloh-Schwabe Pte. Ltd.	Taiwan Branch 9, Fl-2, No. 80 Sung Chiang Road, Taipei, Taiwan	Phone: +886/(0)2/25 68 36 22 Fax: +886/(0)2/25 68 36 20 betty.ho@vstw.vossloh-schwabe.com
Thailand Vossloh-Schwabe Trading Ltd.	3rd Floor (Unit 1) BUI Building 1 175-177 Soi Anumarnratchathon 1 Surawong Road, Kwaeng Suriyawongse Khet Bangrak, Bangkok 10500, Thailand	Phone: +66/(0)2/63 473 11 Fax: +66/(0)2/63 473 13 sales.vstt@vstt.vossloh-schwabe.com
Tunisia Vossloh-Schwabe Tunisie S.A.	Rue de l'énergie, BP. 299 Zone Industrielle de Ben Arous 2013 Tunis, Tunisia	Phone: +216/71/384 900 Fax: +216/71/384 990 hatem.benyahmed@vstu.com.tn
USA, Canada, Mexico Universal™ Lighting Technologies	26 Century Blvd. Nashville, TN 37214-3683, USA	Phone: +1/615/316-5100 Fax: +1/615/316-5205 oem_sales@unvlt.com

Whenever an electric light goes on around the world, Vossloh-Schwabe is likely to have made a key contribution to ensuring that everything works at the flick of a switch.

Headquartered in Germany, Vossloh-Schwabe has been a member of the global Panasonic group since 2002 and counts as a technology leader within the lighting sector. Top-quality, high-performance products form the basis of the company's success.

Whether cost-effective standard components or tailor-made product developments are needed, Vossloh-Schwabe can satisfy even the most diverse market and customer requirements. Vossloh-Schwabe's extensive product portfolio covers all lighting components: LED systems with matching control gear units and state-of-the-art control systems (LiCS) as well as electronic and magnetic ballasts and lampholders.



A member of the Panasonic group **Panasonic**

Vossloh-Schwabe Deutschland GmbH

Hohe Steinert 8 · 58509 Lüdenscheid · Germany
Phone +49/23 51/10 10 · Fax +49/23 51/10 12 17

www.vossloh-schwabe.com

VS LIGHTING SOLUTIONS

All rights reserved © Vossloh-Schwabe
Photos: istockphoto.com; shutterstock.com
Specifications are subject to change without notice
VS Component Systems Standard EN 2016