

SST 02-102-048-20-H-1D1-0.5-J5

Measuring Light Curtains

Measuring Light Curtains

Compatible Receivers:

SSR 02-102-048-20-H-AC2-DN2-0.5-J12

SSR 02-102-048-20-H-AC2-DP2-0.5-J12

SSR 02-102-048-20-H-ANN-DN4-0.5-J12

SSR 02-102-048-20-H-ANN-DP4-0.5-J12



Product Data	
Channel Spacing	20 mm
Function	Transmitter
Operation Mode	Thru Beam
Supply Voltage	18 - 30 V dc
Connection	0.5 m cable with 5 pin, M12 plug
Sensing Range	10 m
Length	1020 mm
Active Height	945 mm
Housing	33 x 36 mm

Technical Data	
Supply Voltage	18 - 30 V dc
Reverse Polarity Protected	Yes
Current Consumption	100 mA
Number of Channels	48
Number of Cross Scanning Beams	142
Number of Parallel Beams	48
Distance, Beams Pinch Point	10 mm
Test Input	Yes
Power On Indicator	Green LED
Light Source	Infrared (880 nm)
Profile Dimensions (w x d)	33 x 36 mm
Housing Material, Front Lens	Polycarbonate
Housing Material, Profile	Aluminium (black anodised)
Cable	5 x 0,2 mm ²
Cable Sleeve	PVC Ø 5,9 mm

Environmental Data	
Vibration	10 - 55 Hz, 0,5 mm
Shock	30 g
Operation Temperature	-30 to +60 °C
Storage Temperature	-40 to +80 °C
Sealing Class	IP 67

Approvals

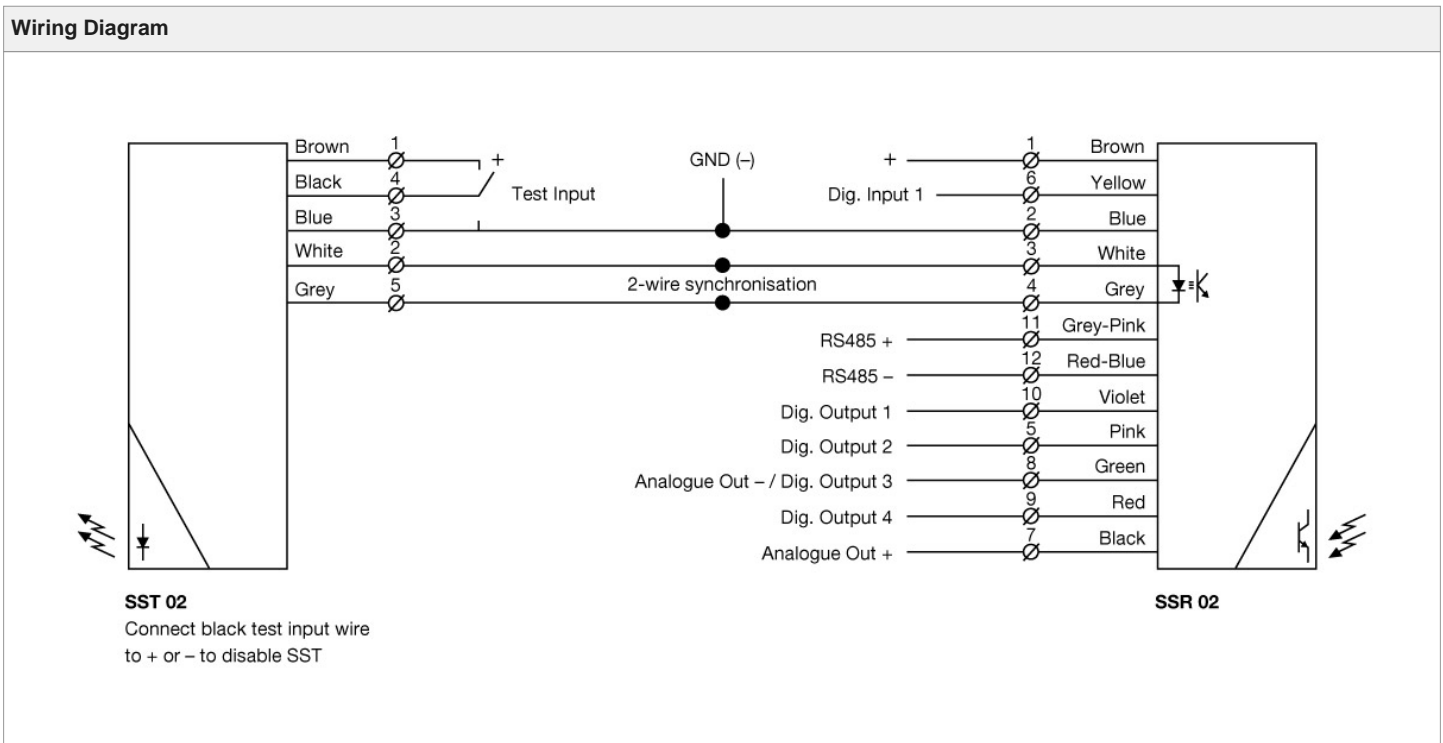



Connections

5 pin, M12

Sensor Plug
(Male)

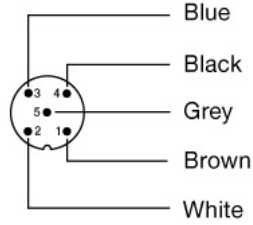
Cable Plug
(Female)



Parallel Displacement



Beam Patterns

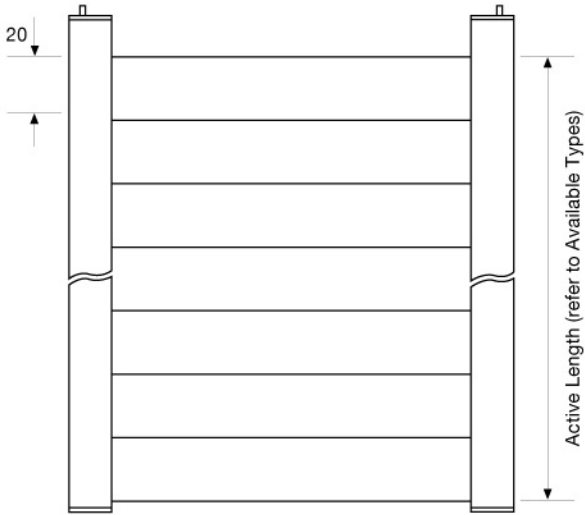

Parallel Beams

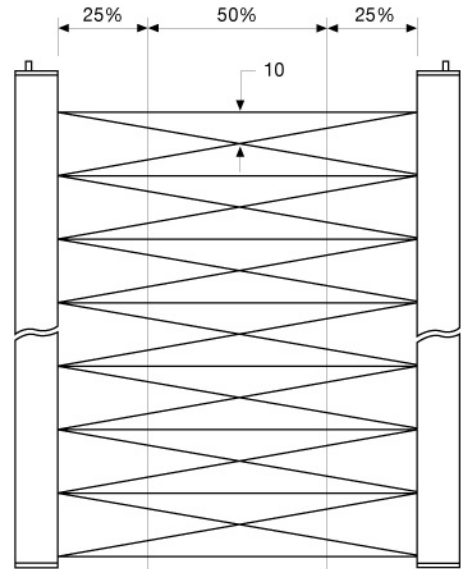

Cross Beams

20 mm channel spacing

Dimensions

