



## Contents

### Distribution Products 01~23

|  |       |
|--|-------|
| Ex9A Series Air Circuit Breaker          | 01~07 |
| Ex9M Series Moulded Case Circuit Breaker | 08~23 |

### Modular DIN Rail Products 24~52

|  |       |
|--|-------|
| Ex9B Series Miniature Circuit Breaker                                | 24~25 |
| Ex9BM Series Miniature Circuit Breaker                               | 26~27 |
| Ex9PN Series Miniature Circuit Breaker                               | 28~29 |
| Ex9BP Series Miniature Circuit Breaker for PV                        | 30~31 |
| Accessories For Miniature Circuit Breaker                            | 32    |
| Ex9CL Residual Current Circuit Breaker                               | 33~34 |
| Ex9CBL Residual Current Circuit Breaker with over-current protection | 35~36 |
| Ex9LE RCD block  | 37~38 |
| Ex9I Switch Disconnecter   | 39~40 |
| Ex9IP Switch Disconnecter for PV                                     | 41~42 |
| Ex9F Fuse Disconnecter   | 43~44 |
| Ex9FP Fuse Disconnecter for PV                                       | 45~46 |
| Ex9U Series Surge Protective Device                                  | 47~50 |
| Ex9UP Series Surge Protective Device for PV                          | 52    |
| Busbars BBU  | 53~54 |

### Motor Control Products 55~79

|                                      |       |
|--------------------------------------|-------|
| Ex9C Series AC Contactor             | 55~65 |
| Ex9R Series Thermal Overload Relay   | 66~69 |
| Ex9CC Series Capacitor Contactor     | 70~71 |
| Ex9RC Series Contactor Relay         | 72~73 |
| Ex9QC Series Electromagnetic Starter | 74~76 |
| Ex9QS Series Star-delta Starter      | 77~79 |

### Combiner Box 80~83

|                                |       |
|--------------------------------|-------|
| PVBx Photovoltaic Combiner Box | 80~81 |
| SUP Smart monitoring Device    | 82~83 |



## Overview

Ex9A Series Air Circuit Breaker is used for power distribution and protection of main lines of low-voltage distribution networks with a rated current ranging between 400A and 4000A, and also for the protection of motors and generators.

As a new generation of smart product, the Ex9A not only has multiple protective functions, but also performs the functions of measurement, communication, and electric power management, able to give the electric characteristics of the line on which it is mounted, exchange data with other devices, and receive control commands from a higher level.

## Characteristic

NOARK's unique high-efficiency arc quenching & extinguishing technology enables the Ex9A to become a genuine zero arcing circuit breaker.

The new design of arcing chamber includes:

- Magnetic-blow arcing technology: to extend the arc and introduce it into the arcing chamber.
- Metal grid: Split arc, to accelerate heat dissipation and prevent high temperature generated by arc.
- Metal mesh: to filter out and absorb the hazardous substances contained in the gas generated from the arc.

NOARK high-efficiency arc quenching & extinguishing technology brings the circuit breaker with the following features:

- High breaking capacity  
 $I_{CS}=I_{CU}=120kA$
- Saving space

Ex9A Series Circuit Breaker has different structural dimensions for different frame sizes, but every size is characterized in "large capacity and miniature," saving mounting space and reducing the cost for users.

Each air circuit breaker model covers several breaking capacities and rated current.

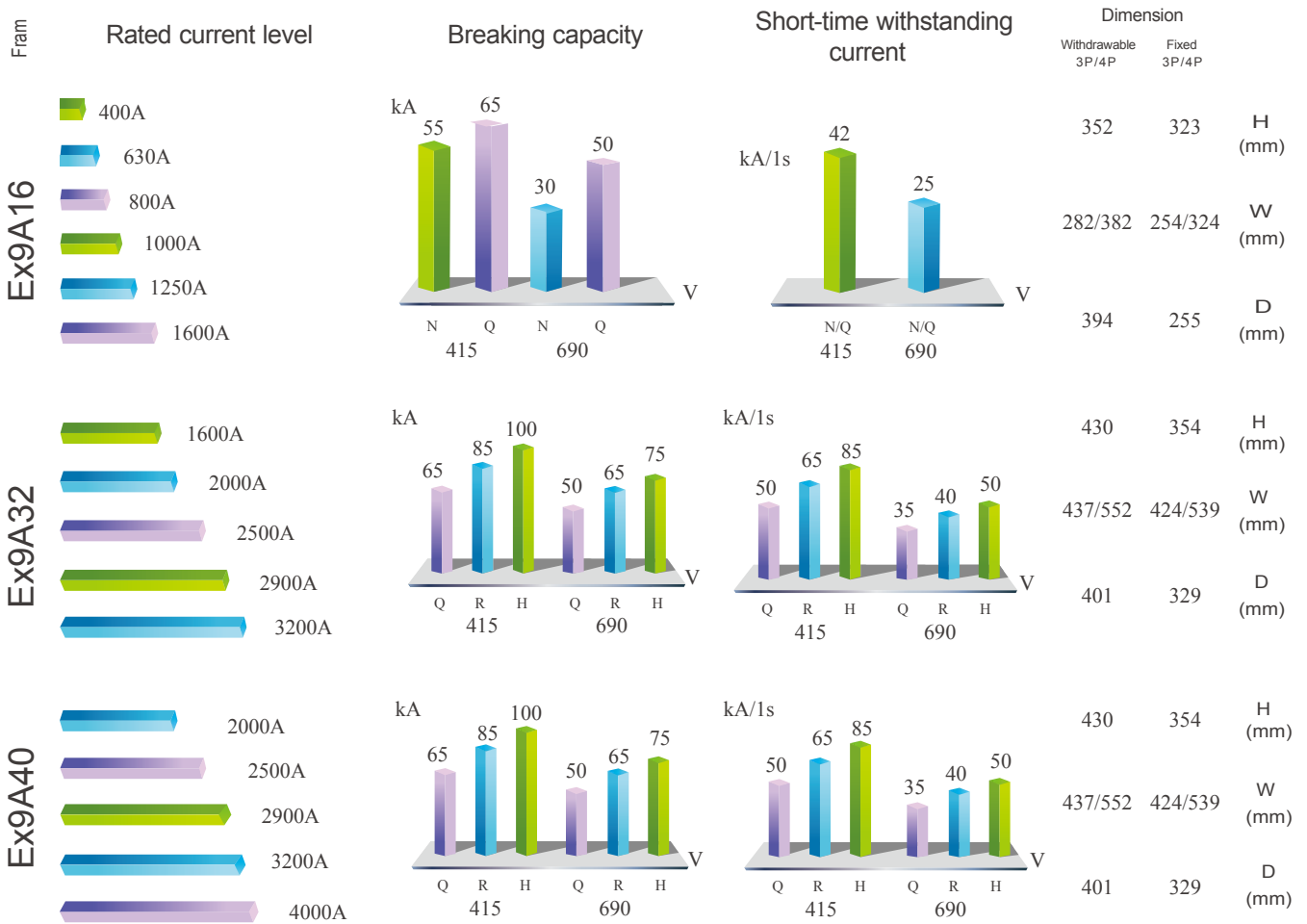

Note: Breaking capacity of circuit breaker is: N-55KA, Q-65KA, R-85KA, H-100KA, V-125KA (under Ue=415V)



### Wiring Flexibility

The user may experience the flexibility and convenience of Ex9A Air Circuit Breaker even though it is provided on a main or a secondary circuit.

Ex9A Air Circuit Breaker, fixed or withdrawable, is featured by:

- Control Circuit

The most sophisticated screwless wiring technology, while maintaining its high degree of protection (IP40), enabling a safer & easier operation and maintenance by the user.

- Several wiring connections for the main circuit:

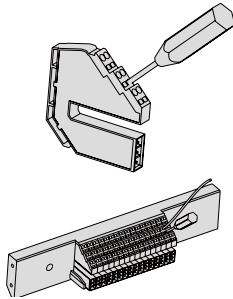

\*The user may select either a horizontal or vertical connection

Horizontal Connection

Vertical Connection

\*Also, the user may select a front connection

Front Connection

\*Hybrid connection supportable and suitable for more stringent mounting conditions and saving space

Hybrid Connection

Hybrid Connection

Flexibility of the Ex9A



## Modularization Design

Withdrawable

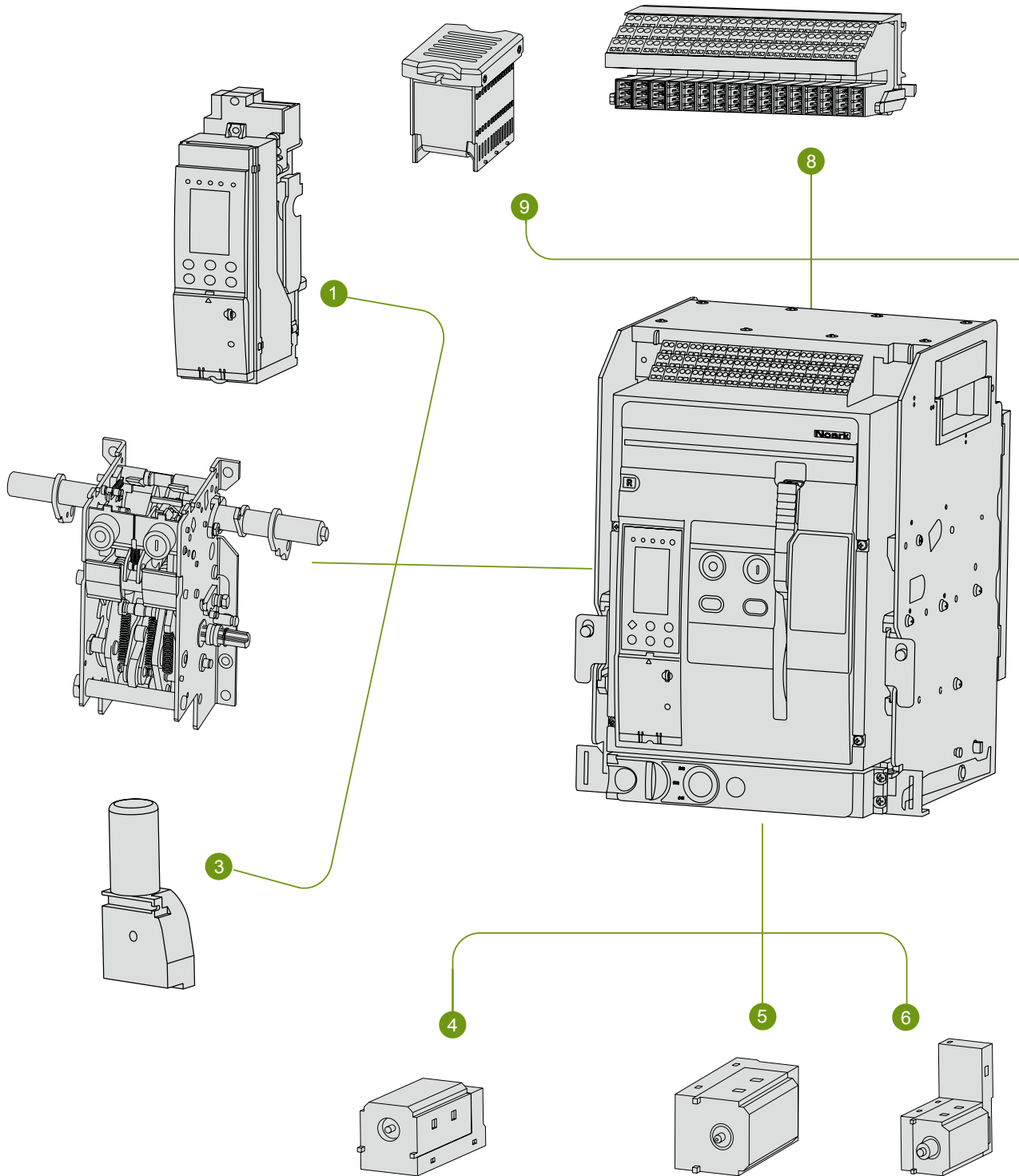

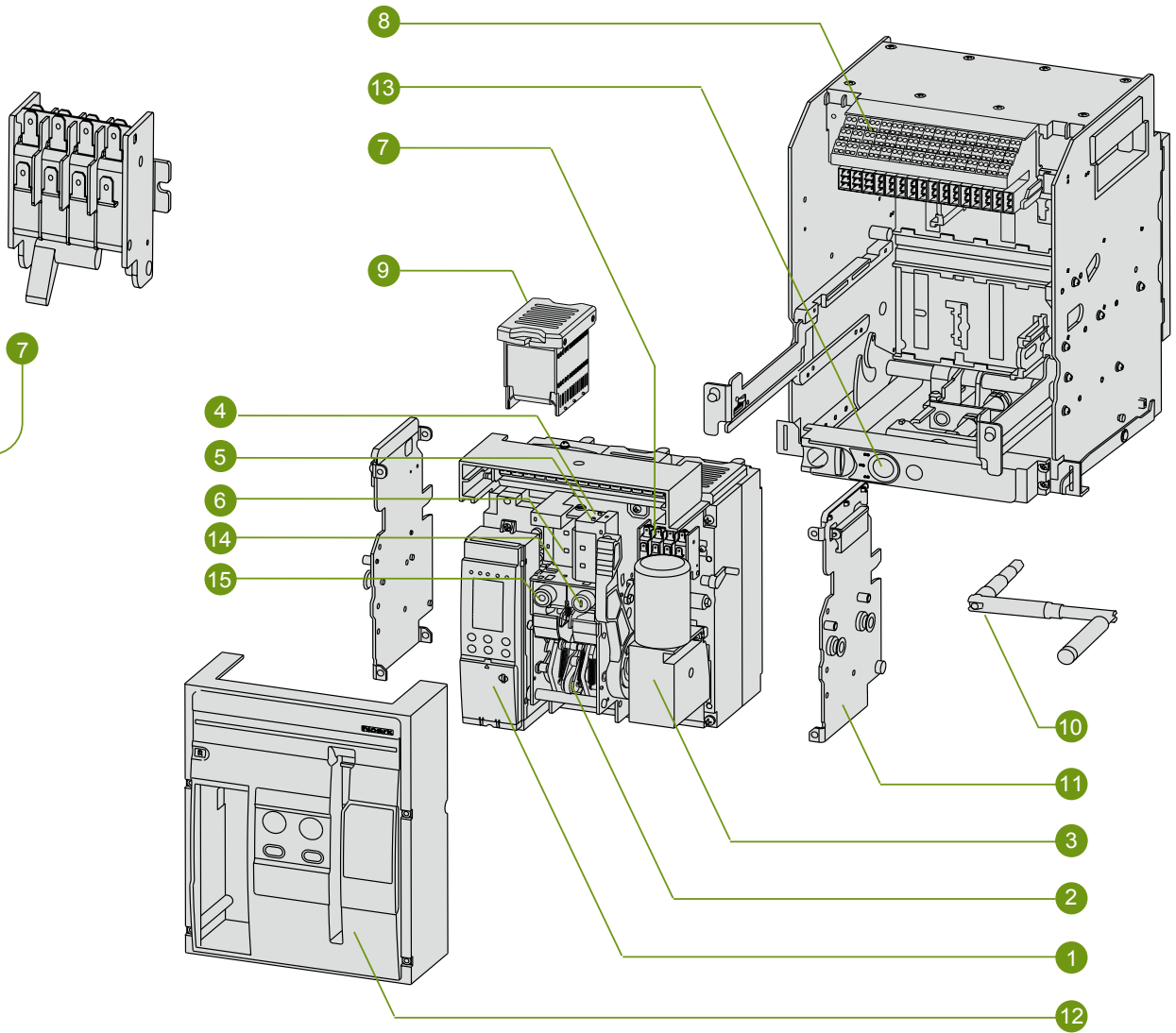



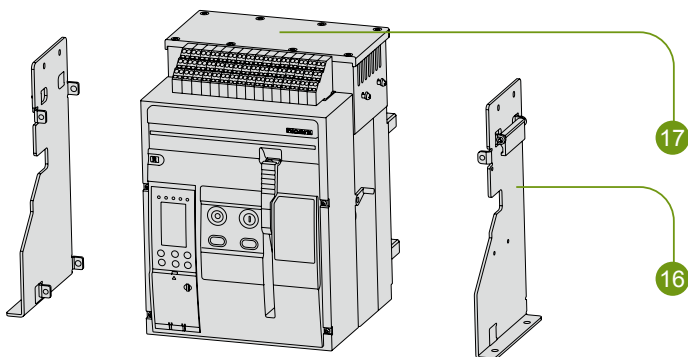



Fixed type



| No. | Designation                              |
|-----|--|
| 1   | Smart Unit                               |
| 2   | Operating Mechanism                      |
| 3   | Electric Motor                           |
| 4   | Shunt Release                            |
| 5   | Closing Release                          |
| 6   | Undervoltage Release                     |
| 7   | Auxiliary Contact                        |
| 8   | Wiring Terminal on the Secondary Circuit |
| 9   | Arcing Chamber                           |
| 10  | Handle                                   |
| 11  | Side Plate                               |
| 12  | Panel                                    |
| 13  | Withdrawable Indicator                   |
| 14  | On Button                                |
| 15  | Off Button                               |
| 16  | Retaining Plate                          |
| 17  | Cover                                    |

## Parameters





| Air Circuit Breaker                       |  |  | Ex9A16  |   | Ex9A32   |   | Ex9A40  |   |
|---|--|--|---|---|--|---|---|---|
| IEC 60947-2                               |  |  |  |  |  |  |  |  |
| Number of poles                           |  |  | 3P  | 4P  | 3P   | 4P  | 3P  | 4P  |
| Rated frame current (A)                   |  |  | 1600  |   | 3200   |   | 4000  |   |
| Electrical performance                    |  |  |   |   |  |   |   |   |
| Operating frequency                       |  |  | 50/60 Hz  |   | 50/60 Hz   |   | 50/60 Hz  |   |
| Version                                   |  |  | Fixed/Withdrawable  |   | Fixed/Withdrawable   |   | Fixed/Withdrawable  |   |
| Rated voltage                             |  |  | 380/400/415/660/690   |   | 380/400/415/660/690  |   | 380/400/415/660/690   |   |
| Rated current                             |  |  | 400-630-800-1000-1250-1600  |   | 1600-2000-2500-2900-3200   |   | 2000-2500-2900-3200-4000  |   |
| Rated insulation voltage                  |  |  | 1000  |   | 1000   |   | 1000  |   |
| Rated impulse withstand voltage           |  |  | 12  |   | 12   |   | 12  |   |
| Type of breaking capacity                 |  |  | N/Q   |   | Q/R/H  |   | Q/R/H   |   |
| Ultimate breaking capacity                |  |  | 55/65   |   | 65/85/100  |   | 65/85/100   |   |
| Rated service breaking capacity           |  |  | 75%   |   | 100%   |   | 100%  |   |
| Short-time withstand current              |  |  | 42  |   | 50/65/85   |   | 50/65/85  |   |
| Rated making current                      |  |  | 121   |   | 143/187/220  |   | 143/187/220   |   |
| Breaking and closing time (ms)            |  |  | 20-30   |   | 20-30  |   | 20-30   |   |
| Acring distance                           |  |  | 0   |   | 0  |   | 0   |   |
| Service life (C-O)                        |  |  | 12500   |   | 10000  |   | 8000  |   |
| Isolation function                        |  |  | ■   |   | ■  |   | ■   |   |
| Protection                                |  |  |   |   |  |   |   |   |
| Smart unit                                |  |  | ■   |   | ■  |   | ■   |   |
| To be used with a fuse                    |  |  | —   |   | —  |   | —   |   |
| N-pole protection capacity                |  |  | —   |   | —  |   | —   |   |
| Accessories                               |  |  | —   |   | —  |   | —   |   |
| Connection and Installation               |  |  |   |   |  |   |   |   |
| Service category                          |  |  | B   |   | B  |   | B   |   |
| Load type                                 |  |  | —   |   | —  |   | —   |   |
| Installation category                     |  |  | IV  |   | IV   |   | IV  |   |
| Pollution degree                          |  |  | 3   |   | 3  |   | 3   |   |
| Operating freq. (cycles/h)                |  |  | —   |   | —  |   | —   |   |
| Connection mode                           |  |  | Top/Bottom  |   | Horizontal/Vertical/Hybrid   |   | Top/Bottom  |   |
| Power supply                              |  |  | fixed   |   | fixed  |   | fixed   |   |
| Installation mode                         |  |  | withdrawable  |   | withdrawable   |   | withdrawable  |   |
| External dimensions(cm)                   |  |  | 254/324   |   | 424/539  |   | 424/539   |   |
| Weight with inclusive release switch (kg) |  |  | 282/382   |   | 437/552  |   | 437/552   |   |
| W (3/4P)                                  |  |  | 23  |   | 354  |   | 354   |   |
| H   |  |  | 352   |   | 430  |   | 430   |   |
| D   |  |  | 329   |   | 401  |   | 401   |   |
| Weight with inclusive release switch (kg) |  |  | 329   |   | 72.5   |   | 72.5  |   |
| W (3/4P)                                  |  |  | 26.5  |   | 121  |   | 141   |   |

■ Standard configuration □ Optional — None





## Parameters

| Air Circuit Breaker                         |  |                     | Switch Disconnector   |   |   |   |   |   |
|---|--|---------------------|---|---|---|---|---|---|
| IEC 60947-2                                 |  |                     |  |  |  |  |  |  |
| Number of poles                             |  |                     | 3P  | 4P  | 3P  | 4P  | 3P  | 4P  |
| Rated frame current (A)                     |  |                     | 1600  |   | 3200  |   | 4000  |   |
| <b>Electrical performance</b>               |  |                     |   |   |   |   |   |   |
| Operating frequency                         |  |                     | 50/60 Hz  |   | 50/60 Hz  |   | 50/60 Hz  |   |
| Version                                     |  |                     | Fixed/Withdrawable  |   | Fixed/Withdrawable  |   | Fixed/Withdrawable  |   |
| Rated voltage U <sub>e</sub> (V)            |  |                     | 380/400/415/660/690   |   | 380/400/415/660/690   |   | 380/400/415/660/690   |   |
| Rated current I <sub>n</sub> (A)            |  |                     | 400-630-800-1000-1250-1600  |   | 1600-2000-2500-2900-3200  |   | 2000-2500-2900-3200-4000  |   |
| Rated insulation voltage U <sub>i</sub> (V) |  |                     | 1000  |   | 1000  |   | 1000  |   |
| Rated impulse withstand voltage             |  |                     | 12  |   | 12  |   | 12  |   |
| Type of breaking capacity                   |  |                     | N/Q   |   | Q/R/H   |   | Q/R/H   |   |
| Short-time withstand current                | I <sub>cw</sub> (kA)                             | 415V                | 42  |   | 50/65/85  |   | 50/65/85  |   |
|   |  | 690V                | 25  |   | 35/40/50  |   | 35/40/50  |   |
| Rated making current                        | I <sub>cm</sub> (kA)                             | 415V                | 121   |   | 143/187/220   |   | 143/187/220   |   |
|   |  | 690V                | 63  |   | 105/143/165   |   | 105/143/165   |   |
| Breaking and closing time (ms)              | breaking   | closing             | 20-30   |   | 20-30   |   | 20-30   |   |
|   |  |                     | < 60  |   | < 70  |   | < 70  |   |
| Arcing distance                             |  |                     | 0   |   | 0   |   | 0   |   |
| Service life (C-O)                          | Mechanical                                       | Without maintenance | 12500   |   | 10000   |   | 8000  |   |
|   |  | Maintenance         | 2500  |   | 1500  |   | 1500  |   |
|   | Electrical                                       | 415V                | 6000  |   | 5000  |   | 3000  |   |
|   |  | 690V                | 3000  |   | 1500  |   | 1000  |   |
| Isolation function                          |  |                     | ■   |   | ■   |   | ■   |   |
| <b>Protection</b>                           |  |                     |   |   |   |   |   |   |
| Smart unit                                  |  |                     | —   |   | —   |   | —   |   |
| To be used with a fuse                      |  |                     | □   |   | □   |   | □   |   |
| N-pole protection capacity                  |  |                     | —   |   | —   |   | —   |   |
| Accessories                                 | Electrical                                       |                     | □   |   | □   |   | □   |   |
|   | Mechanical                                       |                     | □   |   | □   |   | □   |   |
| <b>Connection and Installation</b>          |  |                     |   |   |   |   |   |   |
| Service category                            |  |                     | —   |   | —   |   | —   |   |
| Load type                                   |  |                     | AC23  |   | AC23  |   | AC23  |   |
| Installation category                       | Circuit breaker (including coil at primary side) |                     | IV  |   | IV  |   | IV  |   |
|   | Circuit breaker (except coil at primary side)    |                     | III   |   | III   |   | III   |   |
| Pollution degree                            |  |                     | 3   |   | 3   |   | 3   |   |
| Operating freq. (cycles/h)                  |  |                     | 20  |   | 20  |   | 20  |   |
| Connection mode                             |  |                     | Horizontal/Vertical/Hybrid  |   |   |   |   |   |
| Power supply                                |  |                     | Top/Bottom  |   | Top/Bottom  |   | Top/Bottom  |   |
| Installation mode                           |  |                     | withdrawable  | fixed   | withdrawable  | fixed   | withdrawable  | fixed   |
| External dimensions(cm)                     | W (3/4P)   |                     | 254/324   | 282/382   | 424/539   | 437/552   | 424/539   | 437/552   |
|   | H  |                     | 322   | 352   | 354   | 430   | 354   | 430   |
|   | D  |                     | 255   | 394   | 329   | 401   | 329   | 401   |
| Weight with inclusive release(kg)           |  |                     | 20  | 36  | 50/64   | 96  | 70/84   | 96  |
|   |  |                     | 24  | 52  | 96/118  | 118   | 116/138   | 118   |

■ Standard configuration □ Optional — None



|         |         |         |         |         |
|---------|---------|---------|---------|---------|
| Ex9M1   | Ex9M2   | Ex9M3   | Ex9M4   | Ex9M5   |
| Ex9M1M  | Ex9M2M  | Ex9M3M  | Ex9M4M  | Ex9M5M  |
| Ex9M1SD | Ex9M2SD | Ex9M3SD | Ex9M1SD | Ex9M5SD |
| Ex9MD1  | Ex9MD2  | Ex9MD3  | Ex9MD4  | Ex9MD5  |
| ↓       | ↓       | ↓       | ↓       | ↓       |
| 125A    | 250A    | 400A    | 630A    | 800A    |



Standard type - S and N  
High-breaking capacity type - Q, R and H  
Current limiting type - V and P

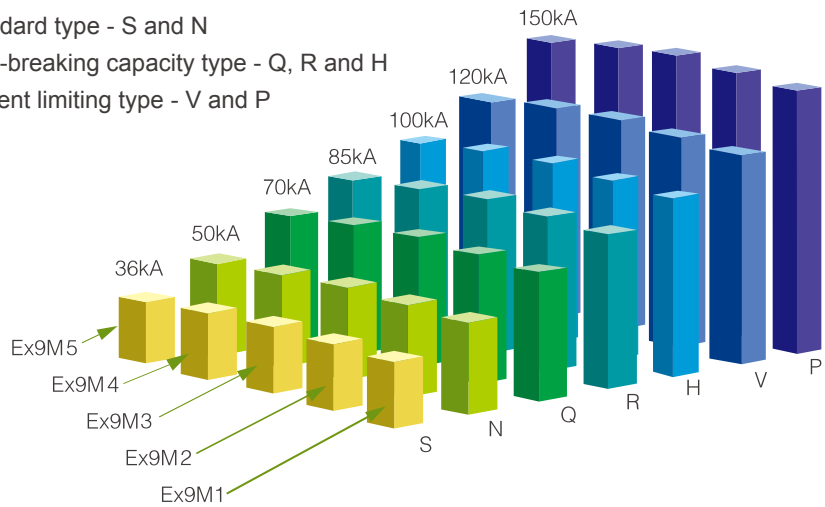

| Model    | Rated current (A) |    |    |    |    |    |    |    |     |     |     |     |     |     |     |     |     |     |     |     |     |     |
|----------|-------------------|----|----|----|----|----|----|----|-----|-----|-----|-----|-----|-----|-----|-----|-----|-----|-----|-----|-----|-----|
|          | 16                | 20 | 25 | 32 | 40 | 50 | 63 | 80 | 100 | 125 | 160 | 180 | 200 | 225 | 250 | 315 | 350 | 400 | 500 | 630 | 700 | 800 |
| Ex9M(D)1 | ■                 | ■  | ■  | ■  | ■  | ■  | ■  | ■  | ■   | ■   |     |     |     |     |     |     |     |     |     |     |     |     |
| Ex9M(D)2 |                   |    |    |    |    |    |    |    |     | ■   | ■   | ■   | ■   | ■   | ■   |     |     |     |     |     |     |     |
| Ex9M(D)3 |                   |    |    |    |    |    |    |    |     |     |     |     |     |     | ■   | ■   | ■   | ■   |     |     |     |     |
| Ex9M(D)4 |                   |    |    |    |    |    |    |    |     |     |     |     |     |     |     |     |     | ■   | ■   | ■   | ■   |     |
| Ex9M(D)5 |                   |    |    |    |    |    |    |    |     |     |     |     |     |     |     |     |     |     |     | ■   | ■   | ■   |

- Note:
- Ex9M(D)1 is adjustable for thermal protection, range: 0.8-1.0 In
  - Ex9M(D)2 is adjustable for thermal and magnetic protection, range: 0.8-1.0 In, 5-10 In
  - Ex9M(D)3, Ex9M(D)4 and Ex9M(D)5 are the same as Ex9M(D)2



## Product Advantages

### Rotating shaft with bearing

Patented technology

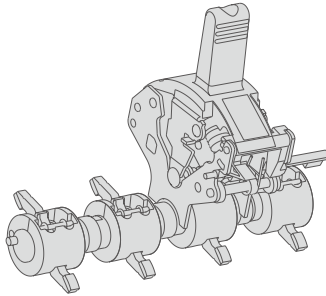

The innovative rotating shaft with bearing allows the circuit breaker to:

- Have a smaller main tension spring force and mechanism friction force
- Have lower mechanism abrasion
- Have a quicker and more flexible mechanism action

The innovative rotating shaft with bearing brings the user:

- A type of high-performance circuit breaker with the smallest operational force

| Operational force | Ex9M(D)1 |     | Ex9M(D)2 |     | Ex9M(D)3 |      | Ex9M(D)4 |      | Ex9M(D)5 |      |
|-------------------|----------|-----|----------|-----|----------|------|----------|------|----------|------|
|                   | 3P       | 4P  | 3P       | 4P  | 3P       | 4P   | 3P       | 4P   | 3P       | 4P   |
| Closing force     | 44N      | 46N | 55N      | 82N | 80N      | 98N  | 110N     | 121N | 110N     | 121N |
| Opening force     | 24N      | 24N | 39N      | 55N | 77N      | 89N  | 98N      | 115N | 98N      | 115N |
| Re-tripping force | 36N      | 38N | 36N      | 54N | 102N     | 115N | 133N     | 148N | 133N     | 148N |

### Snap action

Patented technology

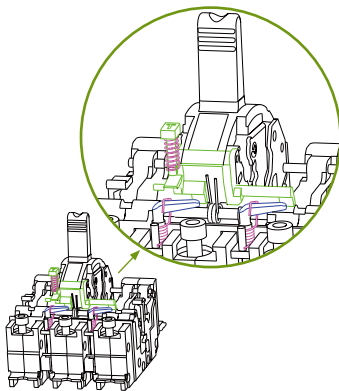

The breaking speed of the circuit breaker is accelerated (breaking time within 2 ms), and its breaking capacity and current limiting capacity are improved by utilizing a gas-flushing principle.

- There are several different breaking capacities for each model of Ex9M circuit breaker. Therefore, users may choose the most optimal breaker as per their actual demands.
- The maximum breaking capacity of each model of Ex9M circuit breaker is up to 150kA.

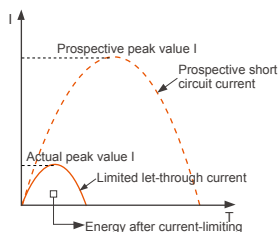

### Current-limiting capacity

Means limiting the increase of the short circuit current in a circuit. In a circuit protected by the Ex9M product series, both the peak value and energy  $I^2t$  of the short circuit current generated are far less than expected.

### U-Type fixed contact design

The pre-breaking technique may be realised by means of a unique U-Type fixed contact.

The pre-breaking technique refers to that of the electrodynamic force generated through the U-Type fixed contact and that which occurs on the moving contact are mutually repulsed when the short circuit current flows through a contact system. The higher the short circuit current, the bigger the repulsive electrodynamic forces they generate simultaneously. Prior to releasing, the electrodynamic repulsive forces may separate the moving contact from the fixed contact, and the equivalent resistance between these two contacts is increased by stretching the electrical arc.

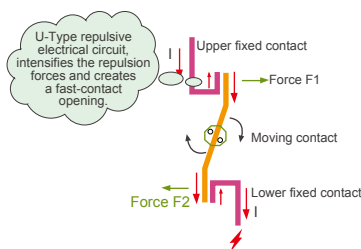

### Double break design

The current-limiting function of the pre-breaking technique is enhanced because of increase in instantaneous arc resistance and arc voltage and a fast drop in the current increase rate.

Reduces the damage and loss of equipment and the power lines caused by a short circuit current, improves the safety, and cuts down on the cost of a secondary protection device.

Compact design, full range of accessories

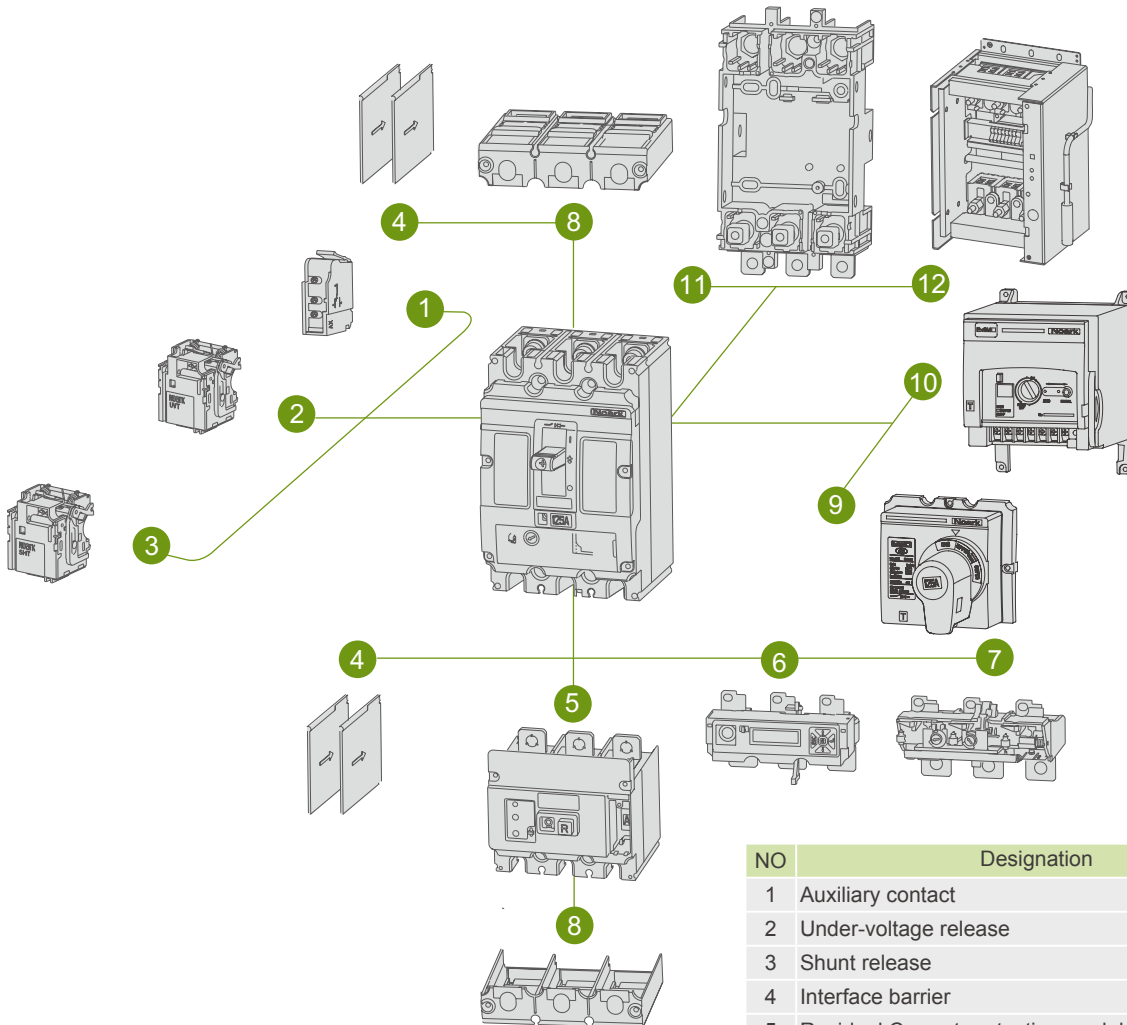

| NO | Designation                        |         |
|----|------------------------------------|---------|
| 1  | Auxiliary contact                  | AX(AL)  |
| 2  | Under-voltage release              | UVT     |
| 3  | Shunt release                      | SHT     |
| 4  | Interface barrier                  | PHS     |
| 5  | Residual Current protection module | Ex9ML   |
| 6  | Electronic release                 | SU20    |
| 7  | Thermo-magnetic release            | TM(M)   |
| 8  | Terminal shield                    | TCV     |
| 9  | Manual operating mechanism         | ERH/RHD |
| 10 | Motor mechanism                    | MOD     |
| 11 | Plug-in rear connector             | PIA     |

## Ex9M Moulded Case Circuit Breaker

| Ex9M                | 1                          | S                      | TM   | AC                         | 125                                      | 3P  |
|---------------------|----------------------------|------------------------|--|----------------------------|--|---|
| Product Code        | Rated Frame Current Code   | Breaking Capacity Code | Tripping device code   | AC/DC Code                 | Rated Current (A)                        | Poles   |
| Ex9M:AC Protection  | 1:125A<br>2:250A<br>3:400A | B:25kA (DC)            | TM:<br>Thermomagnetic , for protection of general power distribution | AC:<br>Alternating current | 125, 100, 80, 63, 50, 40, 32, 25, 20, 16 | 2P  |
| Ex9MD:DC Protection | 4:630A<br>5:800A           | S:36kA                 | M:<br>Magnetic type, for motor protection                            | DC:<br>Direct current      | 250, 225, 200, 180, 160, 125             | 3P  |
|                     |                            | N:50kA                 |  |                            | 400,350, 315,250                         | 4P4T:<br>Neutral protected, on-and -off           |
|                     |                            | Q:70kA                 |  |                            | 630,500,400                              | 4P4I:<br>Neutral protected, without on-and -off   |
|                     |                            | R:85kA                 |  |                            | 800,700,630                              | 4P4U:<br>Neutral unprotected, on-and -off         |
|                     |                            | H:100kA                |  |                            |  | 4P4N:<br>Neutral unprotected, without on-and -off |
|                     |                            | V:120kA (AC)           |  |                            |  |   |
|                     |                            | P:150kA (AC)           |  |                            |  |   |

### Example:

"Ex9M1 S TM DC 125 3P": means DC Moulded Case Circuit Breaker of the Ex9M series, frame current 125A, breaking capacity 36kA, 3 poles, rated current 125A with thermal-magnetic distribution protection trip unit.

Note: :2P only for Ex9M1, Ex9M2, Ex9MD1, Ex9MD2  
:Special Product – Please contact NOARK before placing an order

## Ex9M Moulded Case Circuit Breaker(Electronic type)

| Ex9M                   | 2                                    | S                      | SU20S   | AC                      | 250               | 3P  |
|------------------------|--------------------------------------|------------------------|---|-------------------------|-------------------|---|
| Product Code           | Rated Frame Current Code             | Breaking Capacity Code | Tripping device code                                  | AC/DC Code              | Rated Current (A) | Poles   |
| Ex9M:<br>AC Protection | 2:250A<br>3:400A<br>4:630A<br>5:800A | S:36kA                 | SU20S:<br>Basic electronic distribution protection    | AC: alternating current | 250,160,100,63,32 | 3P  |
|                        |                                      | N:50kA                 | SU20C:<br>Advanced electronic distribution protection |                         | 400               | 4P4T:<br>Neutral protected, on-and -off           |
|                        |                                      | Q:70kA                 | SU20SM:<br>Basic electronic motor protection          |                         | 630               | 4P4I:<br>Neutral protected, without on-and -off   |
|                        |                                      | R:85kA                 | SU20CM:<br>Advanced electronic motor protection       |                         | 800               | 4P4U:<br>Neutral unprotected, on-and -off         |
|                        |                                      | H:100kA                |   |                         |                   | 4P4N:<br>Neutral unprotected, without on-and -off |
|                        |                                      | V:120kA                |   |                         |                   |   |
|                        |                                      | P:150kA                |   |                         |                   |   |

### Example:

Ex9M2S SU20S AC250 3P:Ex9M series MCCB, frame current 250A, breaking capacity 36kA, 3 poles, rated current 250A, with basic electronic distributon protection trip unit

**Notes:**COM21 communication module is needed to realize the communication between the Ex9M electronic circuit breaker and the upper computer, which could also realize the remote signal, remote adjustment and measurement.  
MOD motor mechanism is needed to realize the function of remote control.

## Ex9MSD Switch disconnector

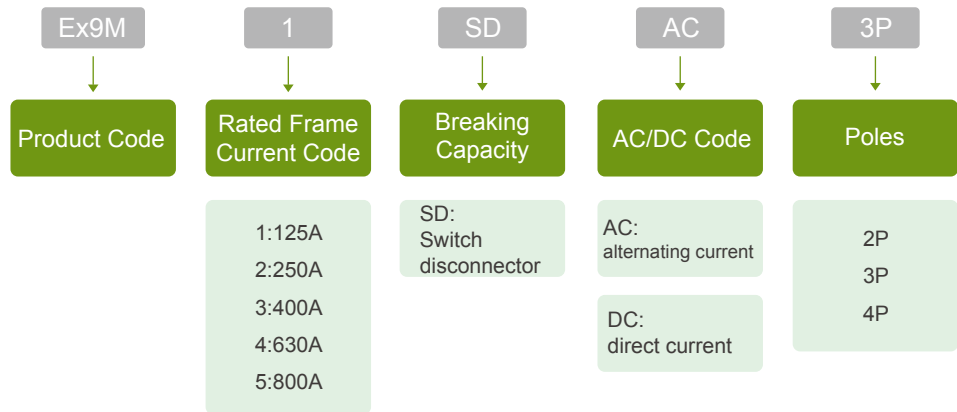

### Example:

Ex9M1SD DC 3P: means an Ex9MSD switch disconnector, frame current 125A, DC, 3 poles.

## Ex9ML Residual Current Protection Module

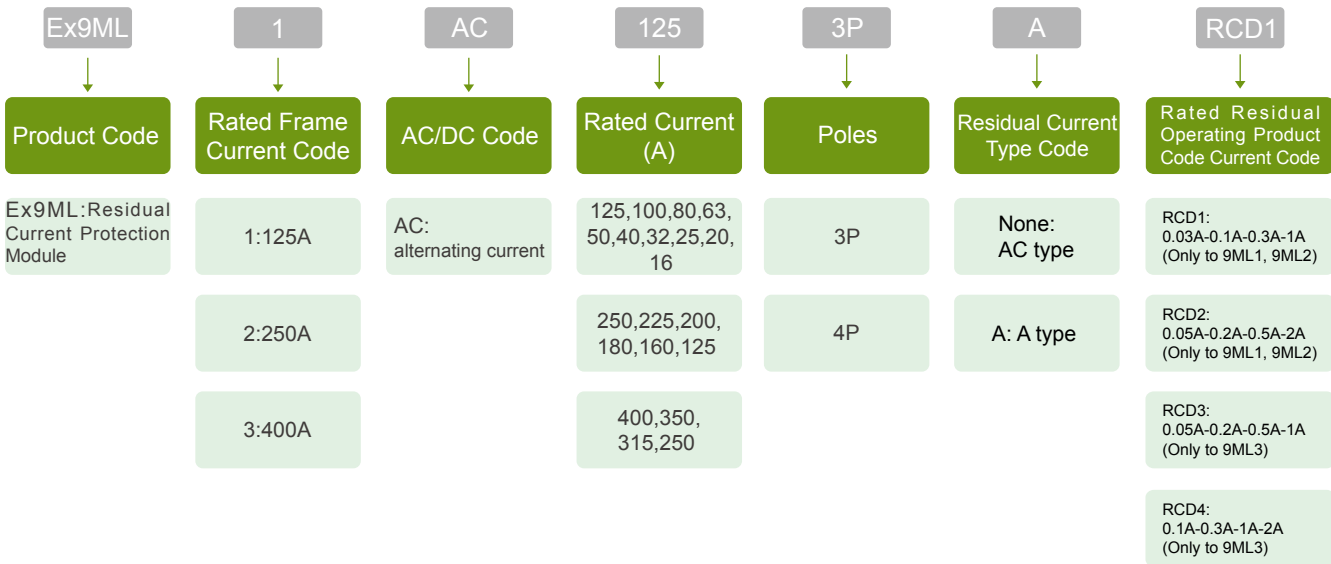

### Example:

Ex9ML1 AC125 3P RCD1 stands for Ex9ML series AC Residual Current Protection Module, frame current 125A, 3 poles, rated current 125A, and four adjustable grades of rated residual operating current: 0.05A-0.2A-0.5A-2A.

**Notes:** The series standard delay time: four adjustable grades: 0.1S-0.3S-0.5S-1S.

### ELCB:

For any order including Moulded Case Circuit Breaker and Residual Current Protection Module, it is approved to abbreviated two SKU codes as one SKU code.

E.g.: The SKU codes of a Ex9M1 moulded case circuit breaker, 125A, 36KA, 3 poles, with thermal release, with leakage protection of four adjusted grades: 0.03A-0.1A-0.3A-1A are: Ex9M1 S TM AC 125 3P and Ex9ML1 AC125 3P RCD1, can be abbreviated as Ex9M1 S TM AC125 3P RCD1.



## Ex9M Series Products Accessories

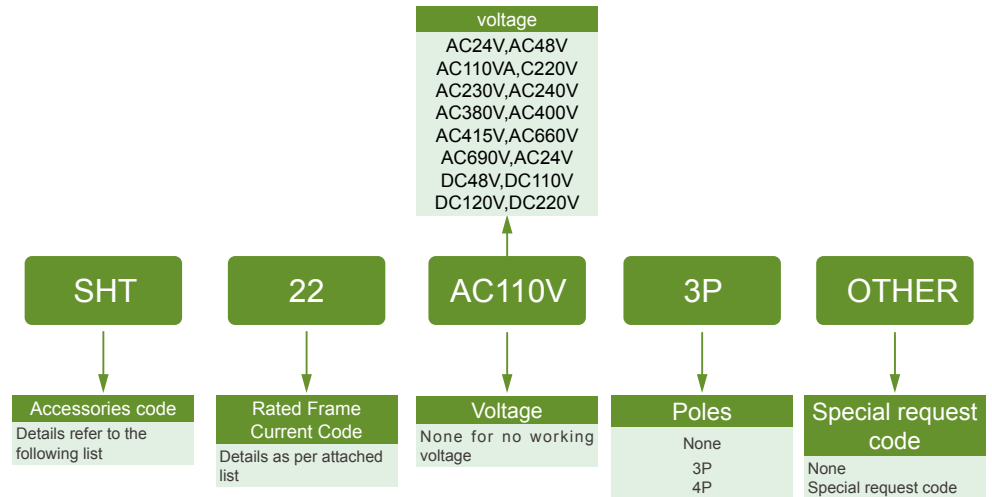

### example:



SHT 22 AC110V:shunt release for 9M2, with control voltage of AC110V  
RHD 23:direct rotary handle for 9M3

## Accessories



| Name                     | Specification | 9M1   | 9M2   | 9M3                                | 9M4   | 9M5   |
|--------------------------|---------------|-------|-------|------------------------------------|-------|-------|
| Auxiliary contact        | AX            |       |       | AX21                               |       |       |
| Alarm contact            | AL            |       |       | AL21                               |       |       |
| Shunt release            | SHT           | SHT21 |       |                                    | SHT22 |       |
| Under-voltage release    | UVT           | UVT21 |       |                                    | UVT22 |       |
| Direct rotary handle     | RHD           | RHD21 | SHT21 | RHD23                              |       | RHD24 |
| Extended rotary handle   | ERH           | ERH21 | ERH22 | ERH23                              |       | ERH24 |
| Motor mechanism          | MOD           | MOD21 | MOD22 | MOD23                              |       | MOD24 |
| Handle lock              | KLK           | KLK21 | KLK22 | KLK23                              |       | KLK24 |
| Mechanical interlock     | MIT           | MIT21 | MIT22 | MIT23                              |       | MIT24 |
| Terminal shield          | TCV           | TCV21 | TCV22 | TCV23                              |       | TCV24 |
| Extended terminal shield | TCE           | TCE21 | TCE22 | TCE23                              |       | TCE24 |
| Rear connection plate    | RCP           | RCP21 | RCP22 | RCP23                              | RCP24 | RCP25 |
| Draw-out base            | DOB           | —     | —     | DOB23                              | DOB24 | DOB25 |
| Plug-in base             | PIA           | PIA21 | PIA22 | PIA23                              | —     | —     |
| Din-rail adaptor         | DRA           | DRA21 | DRA22 | —                                  | —     | —     |
| Front panel escutcheon   | CDP           | CDP21 | CDP22 | CDP23                              |       | CDP24 |
| Communication module     | COM           |       |       | COM21(Used for 9M electronic type) |       |       |
| Battery module           | BAB           |       |       | BAB21(Used for 9M electronic type) |       |       |

YES   
 Optional   
 NO

## Parameters



| Ex9M Series Circuit Breaker for Power Distribution Protection |   |                      | Ex9M1  |    |    |    |     |     |     | Ex9M2   |    |    |    |     |     |     |
|---|---|----------------------|--|----|----|----|-----|-----|-----|---|----|----|----|-----|-----|-----|
| For protection of general power distribution                  |   |                      |  |    |    |    |     |     |     |  |    |    |    |     |     |     |
| Number of poles   |   |                      | 2P/3P/4P   |    |    |    |     |     |     | 2P/3P/4P  |    |    |    |     |     |     |
| Rated frame current (A)                                       |   |                      | 125  |    |    |    |     |     |     | 250   |    |    |    |     |     |     |
| Electrical performance  |   |                      |  |    |    |    |     |     |     |   |    |    |    |     |     |     |
| Working frequency(Hz)   |   |                      | 50/60  |    |    |    |     |     |     | 50/60   |    |    |    |     |     |     |
| Rated operational voltage(V)                                  |   |                      | 380/400/415/660/690  |    |    |    |     |     |     | 380/400/415/660/690   |    |    |    |     |     |     |
| Rated current (A)   |   |                      | 16-20-25-32-40-50-63-80-100-125  |    |    |    |     |     |     | 125-160 -180-200-225-250  |    |    |    |     |     |     |
| Rated insulation voltage (V)                                  |   |                      | 800  |    |    |    |     |     |     | 800   |    |    |    |     |     |     |
| Rated impulse withstand voltage (kV)                          |   |                      | 8  |    |    |    |     |     |     | 8   |    |    |    |     |     |     |
| Type of breaking  |   |                      | S  | N  | Q  | R  | H   | V   | P   | S   | N  | Q  | R  | H   | V   | P   |
| Ultimate breaking capacity (kA)                               | $I_{cu}$  | 380/400/415V         | 36   | 50 | 70 | 85 | 100 | 120 | 150 | 36  | 50 | 70 | 85 | 100 | 120 | 150 |
|   |   | 660/690/720V         | 5  | 5  | 5  | 5  | 6   | 6   | 8   | 6   | 6  | 6  | 6  | 8   | 8   | 10  |
| Service breaking capacity (% $I_{cu}$ )                       | $I_{cs}$  | 415V                 | 100%   |    |    |    |     |     |     | 100%  |    |    |    |     |     |     |
|   |   | 690V                 | 100%   |    |    |    |     |     |     | 100%  |    |    |    |     |     |     |
| Isolation function  |   |                      | ■  |    |    |    |     |     |     | ■   |    |    |    |     |     |     |
| Utilization category  |   |                      | A  |    |    |    |     |     |     | A   |    |    |    |     |     |     |
| Service life (C-O cycle)                                      | Mechanical  | Actual mean value    | 15000  |    |    |    |     |     |     | 15000   |    |    |    |     |     |     |
|   |   | Test value           | 7000   |    |    |    |     |     |     | 7000  |    |    |    |     |     |     |
|   | Electrical 415V   | Actual value         | 5000   |    |    |    |     |     |     | 5000  |    |    |    |     |     |     |
|   |   | Standard value       | 1000   |    |    |    |     |     |     | 1000  |    |    |    |     |     |     |
| Protection  |   |                      |  |    |    |    |     |     |     |   |    |    |    |     |     |     |
| Thermomagnetic  | Long-time delay   |                      | $(0.8-0.9-1.0) \times I_n$   |    |    |    |     |     |     | $(0.8-0.9-1.0) \times I_n$  |    |    |    |     |     |     |
|   | Instantaneous   |                      | $10 \times I_n$  |    |    |    |     |     |     | $(5-6-7-8-9-10) \times I_n$   |    |    |    |     |     |     |
| Electronic  | SU20S Basic type<br>SU20C Advanced type   | Long-time delay      | —  |    |    |    |     |     |     | $(0.4-1.0) \times I_n$  |    |    |    |     |     |     |
|   |   | Short-time delay     | —  |    |    |    |     |     |     | $(1.5-10) \times I_f$   |    |    |    |     |     |     |
|   |   | Instantaneous        | —  |    |    |    |     |     |     | $(1.5-12) \times I_n$   |    |    |    |     |     |     |
| Control and indication  |   |                      |  |    |    |    |     |     |     |   |    |    |    |     |     |     |
| Control mode  | Manual  | Direct (RHD)         | □  |    |    |    |     |     |     | □   |    |    |    |     |     |     |
|   |   | Extended(ERH)        | □  |    |    |    |     |     |     | □   |    |    |    |     |     |     |
|   |   | Motor mechanism(MOD) | □  |    |    |    |     |     |     | □   |    |    |    |     |     |     |
| Shunt release (SHT)   |   |                      | □  |    |    |    |     |     |     | □   |    |    |    |     |     |     |
| Under-voltage release (UVT)                                   |   |                      | □  |    |    |    |     |     |     | □   |    |    |    |     |     |     |
| Auxiliary contact (AX)  |   |                      | □  |    |    |    |     |     |     | □   |    |    |    |     |     |     |
| Alarm contact (AL)  |   |                      | □  |    |    |    |     |     |     | □   |    |    |    |     |     |     |
| Connection and installation                                   |   |                      |  |    |    |    |     |     |     |   |    |    |    |     |     |     |
| Degree of protection  | All sides   |                      | IP40   |    |    |    |     |     |     | IP40  |    |    |    |     |     |     |
|   | Wiring terminal   |                      | IP20   |    |    |    |     |     |     | IP20  |    |    |    |     |     |     |
| Wiring  | Wiring assembly   |                      | Front/Rear   |    |    |    |     |     |     | Front/Rear  |    |    |    |     |     |     |
|   | Plug-in base(PIA)   |                      | □  |    |    |    |     |     |     | □   |    |    |    |     |     |     |
|   | Draw-out base(DOB)  |                      | —  |    |    |    |     |     |     | —   |    |    |    |     |     |     |
| Terminal shield (TCV)   | Front   |                      | □  |    |    |    |     |     |     | □   |    |    |    |     |     |     |
|   | Rear  |                      | —  |    |    |    |     |     |     | —   |    |    |    |     |     |     |
| Key lock (KLK)  |   |                      | ON/OFF position  |    |    |    |     |     |     | ON/OFF position   |    |    |    |     |     |     |
| Phase shield (PHS)  |   |                      | ■  |    |    |    |     |     |     | ■   |    |    |    |     |     |     |
| Mechanical interlock(MIT)                                     |   |                      | □  |    |    |    |     |     |     | □   |    |    |    |     |     |     |
| External dimensions (mm)<br>$W \times H \times D$             |  | $a(2^{*}/3/4)$       | 62/90/120  |    |    |    |     |     |     | 70/105/140  |    |    |    |     |     |     |
|   |   | b                    | 140  |    |    |    |     |     |     | 157   |    |    |    |     |     |     |
|   |   | c                    | 81.6   |    |    |    |     |     |     | 91.5  |    |    |    |     |     |     |
| Weight (kg)   | 2P  |                      | 0.9  |    |    |    |     |     |     | 1.2   |    |    |    |     |     |     |
|   | 3P  |                      | 1.2  |    |    |    |     |     |     | 1.7   |    |    |    |     |     |     |
|   | 4P  |                      | 1.7  |    |    |    |     |     |     | 2.2   |    |    |    |     |     |     |

■ Standard □ Optional — None \* only Ex9M1, Ex9M2 have 2P. Note: Rated current of electronic MCCB, rated current of electronic Ex9M2 is 250A, 160A, 100A, 63A and 32A.

| Ex9M3   |    |    |    |     |     |     |  | Ex9M4   |    |    |    |     |     |     |  | Ex9M5   |    |    |    |     |     |     |  |
|---|----|----|----|-----|-----|-----|--|---|----|----|----|-----|-----|-----|--|---|----|----|----|-----|-----|-----|--|
|  |    |    |    |     |     |     |  |  |    |    |    |     |     |     |  |  |    |    |    |     |     |     |  |
| 3P/4P   |    |    |    |     |     |     |  | 3P/4P   |    |    |    |     |     |     |  | 3P/4P   |    |    |    |     |     |     |  |
| 400   |    |    |    |     |     |     |  | 630   |    |    |    |     |     |     |  | 800   |    |    |    |     |     |     |  |
| 50/60   |    |    |    |     |     |     |  | 50/60   |    |    |    |     |     |     |  | 50/60   |    |    |    |     |     |     |  |
| 380/400/415/660/690   |    |    |    |     |     |     |  | 380/400/415/660/690   |    |    |    |     |     |     |  | 380/400/415/660/690   |    |    |    |     |     |     |  |
| 250-315-350-400   |    |    |    |     |     |     |  | 400-500-630   |    |    |    |     |     |     |  | 630-700-800   |    |    |    |     |     |     |  |
| 800   |    |    |    |     |     |     |  | 800   |    |    |    |     |     |     |  | 800   |    |    |    |     |     |     |  |
| 8   |    |    |    |     |     |     |  | 8   |    |    |    |     |     |     |  | 8   |    |    |    |     |     |     |  |
| S   | N  | Q  | R  | H   | V   | P   |  | S   | N  | Q  | R  | H   | V   | P   |  | S   | N  | Q  | R  | H   | V   | P   |  |
| 36  | 50 | 70 | 85 | 100 | 120 | 150 |  | 36  | 50 | 70 | 85 | 100 | 120 | 150 |  | 36  | 50 | 70 | 85 | 100 | 120 | 150 |  |
| 10  | 10 | 10 | 10 | 12  | 12  | 15  |  | 10  | 10 | 10 | 10 | 12  | 12  | 15  |  | 10  | 10 | 10 | 10 | 12  | 12  | 15  |  |
| 100%  |    |    |    |     |     |     |  | 100%  |    |    |    |     |     |     |  | 100%  |    |    |    |     |     |     |  |
| 100%  |    |    |    |     |     |     |  | 100%  |    |    |    |     |     |     |  | 100%  |    |    |    |     |     |     |  |
| ■   |    |    |    |     |     |     |  | ■   |    |    |    |     |     |     |  | ■   |    |    |    |     |     |     |  |
| A   |    |    |    |     |     |     |  | A   |    |    |    |     |     |     |  | A   |    |    |    |     |     |     |  |
| 10000   |    |    |    |     |     |     |  | 10000   |    |    |    |     |     |     |  | 5000  |    |    |    |     |     |     |  |
| 4000  |    |    |    |     |     |     |  | 4000  |    |    |    |     |     |     |  | 2500  |    |    |    |     |     |     |  |
| 2000  |    |    |    |     |     |     |  | 2000  |    |    |    |     |     |     |  | 1000  |    |    |    |     |     |     |  |
| 1000  |    |    |    |     |     |     |  | 1000  |    |    |    |     |     |     |  | 500   |    |    |    |     |     |     |  |
| (0.8-0.9-1.0)×I <sub>n</sub>  |    |    |    |     |     |     |  | (0.8-0.9-1.0)×I <sub>n</sub>  |    |    |    |     |     |     |  | (0.8-0.9-1.0)×I <sub>n</sub>  |    |    |    |     |     |     |  |
| (5-6-7-8-9-10)×I <sub>n</sub>   |    |    |    |     |     |     |  | (5-6-7-8-9-10)×I <sub>n</sub>   |    |    |    |     |     |     |  | (5-6-7-8-9-10)×I <sub>n</sub>   |    |    |    |     |     |     |  |
| (0.4~1.0)×I <sub>n</sub>  |    |    |    |     |     |     |  | (0.4~1.0)×I <sub>n</sub>  |    |    |    |     |     |     |  | (0.4~1.0)×I <sub>n</sub>  |    |    |    |     |     |     |  |
| (1.5~10)×I <sub>r</sub>   |    |    |    |     |     |     |  | (1.5~10)×I <sub>r</sub>   |    |    |    |     |     |     |  | (1.5~10)×I <sub>r</sub>   |    |    |    |     |     |     |  |
| (1.5~12)×I <sub>n</sub>   |    |    |    |     |     |     |  | (1.5~12)×I <sub>n</sub>   |    |    |    |     |     |     |  | (1.5~12)×I <sub>n</sub>   |    |    |    |     |     |     |  |
| □   |    |    |    |     |     |     |  | □   |    |    |    |     |     |     |  | □   |    |    |    |     |     |     |  |
| □   |    |    |    |     |     |     |  | □   |    |    |    |     |     |     |  | □   |    |    |    |     |     |     |  |
| □   |    |    |    |     |     |     |  | □   |    |    |    |     |     |     |  | □   |    |    |    |     |     |     |  |
| □   |    |    |    |     |     |     |  | □   |    |    |    |     |     |     |  | □   |    |    |    |     |     |     |  |
| □   |    |    |    |     |     |     |  | □   |    |    |    |     |     |     |  | □   |    |    |    |     |     |     |  |
| □   |    |    |    |     |     |     |  | □   |    |    |    |     |     |     |  | □   |    |    |    |     |     |     |  |
| □   |    |    |    |     |     |     |  | □   |    |    |    |     |     |     |  | □   |    |    |    |     |     |     |  |
| IP40  |    |    |    |     |     |     |  | IP40  |    |    |    |     |     |     |  | IP40  |    |    |    |     |     |     |  |
| IP20  |    |    |    |     |     |     |  | IP20  |    |    |    |     |     |     |  | IP20  |    |    |    |     |     |     |  |
| Front/Rear  |    |    |    |     |     |     |  | Front/Rear  |    |    |    |     |     |     |  | Front/Rear  |    |    |    |     |     |     |  |
| □   |    |    |    |     |     |     |  | —   |    |    |    |     |     |     |  | —   |    |    |    |     |     |     |  |
| □   |    |    |    |     |     |     |  | □   |    |    |    |     |     |     |  | □   |    |    |    |     |     |     |  |
| □   |    |    |    |     |     |     |  | □   |    |    |    |     |     |     |  | □   |    |    |    |     |     |     |  |
| —   |    |    |    |     |     |     |  | —   |    |    |    |     |     |     |  | —   |    |    |    |     |     |     |  |
| ON/OFF position   |    |    |    |     |     |     |  | ON/OFF position   |    |    |    |     |     |     |  | ON/OFF position   |    |    |    |     |     |     |  |
| ■   |    |    |    |     |     |     |  | ■   |    |    |    |     |     |     |  | ■   |    |    |    |     |     |     |  |
| □   |    |    |    |     |     |     |  | □   |    |    |    |     |     |     |  | □   |    |    |    |     |     |     |  |
| 140/185   |    |    |    |     |     |     |  | 195/260   |    |    |    |     |     |     |  | 195/260   |    |    |    |     |     |     |  |
| 255   |    |    |    |     |     |     |  | 300   |    |    |    |     |     |     |  | 300   |    |    |    |     |     |     |  |
| 118.5   |    |    |    |     |     |     |  | 142   |    |    |    |     |     |     |  | 142   |    |    |    |     |     |     |  |
| —   |    |    |    |     |     |     |  | —   |    |    |    |     |     |     |  | —   |    |    |    |     |     |     |  |
| 5.0   |    |    |    |     |     |     |  | 10.2  |    |    |    |     |     |     |  | 10.2  |    |    |    |     |     |     |  |
| 6.6   |    |    |    |     |     |     |  | 13.5  |    |    |    |     |     |     |  | 13.5  |    |    |    |     |     |     |  |





## Parameters

| Ex9M Series Circuit Breaker for motor protection |   |                      | Ex9M1M   |    |           |    |     |     |     | Ex9M2M  |    |            |    |     |     |     |  |  |
|--|---|----------------------|--|----|-----------|----|-----|-----|-----|---|----|------------|----|-----|-----|-----|--|--|
| For motor protection                             |   |                      |  |    |           |    |     |     |     |  |    |            |    |     |     |     |  |  |
| Number of poles                                  |   |                      | 2P/3P/4P   |    |           |    |     |     |     | 2P/3P/4P  |    |            |    |     |     |     |  |  |
| Rated frame current (A)                          |   |                      | 125  |    |           |    |     |     |     | 250   |    |            |    |     |     |     |  |  |
| Electrical performance                           |   |                      |  |    |           |    |     |     |     |   |    |            |    |     |     |     |  |  |
| Working frequency(Hz)                            |   |                      | 50/60  |    |           |    |     |     |     | 50/60   |    |            |    |     |     |     |  |  |
| Rated operational voltage (V) $U_e$              |   |                      | 380/400/415/660/690  |    |           |    |     |     |     | 380/400/415/660/690   |    |            |    |     |     |     |  |  |
| Rated current (A) $I_n$                          |   |                      | 16-20-25-32-40-50-63-80-100-125  |    |           |    |     |     |     | 125-160 -180-200-225-250  |    |            |    |     |     |     |  |  |
| Rated insulation voltage (V) $U_i$               |   |                      | 800  |    |           |    |     |     |     | 800   |    |            |    |     |     |     |  |  |
| Rated impulse withstand voltage (kV) $U_{imp}$   |   |                      | 8  |    |           |    |     |     |     | 8   |    |            |    |     |     |     |  |  |
| Type of breaking                                 |   |                      | S  | N  | Q         | R  | H   | V   | P   | S   | N  | Q          | R  | H   | V   | P   |  |  |
| Ultimate breaking capacity (kA) $I_{cu}$         |   |                      | 36   | 50 | 70        | 85 | 100 | 120 | 150 | 36  | 50 | 70         | 85 | 100 | 120 | 150 |  |  |
| Service breaking capacity (% $I_{cu}$ ) $I_{cs}$ |   |                      | 5  | 5  | 5         | 5  | 6   | 6   | 8   | 6   | 6  | 6          | 6  | 8   | 8   | 10  |  |  |
| Service breaking capacity (kA) $I_{cs}$          |   |                      | 415V<br>690V   |    |           |    |     |     |     | 100%<br>100%  |    |            |    |     |     |     |  |  |
| Isolation function                               |   |                      | ■  |    |           |    |     |     |     | ■   |    |            |    |     |     |     |  |  |
| Utilization category                             |   |                      | A  |    |           |    |     |     |     | A   |    |            |    |     |     |     |  |  |
| Service life (C-O cycle)                         | Mechanical  | Actual mean value    | 15000  |    |           |    |     |     |     | 15000   |    |            |    |     |     |     |  |  |
|  |   | Test value           | 7000   |    |           |    |     |     |     | 7000  |    |            |    |     |     |     |  |  |
|  | Electrical  | Actual value         | 5000   |    |           |    |     |     |     | 5000  |    |            |    |     |     |     |  |  |
|  |   | Standard value       | 1000   |    |           |    |     |     |     | 1000  |    |            |    |     |     |     |  |  |
| Protection                                       |   |                      |  |    |           |    |     |     |     |   |    |            |    |     |     |     |  |  |
| Magnetic   | Long-time delay   |                      | —  |    |           |    |     |     |     | —   |    |            |    |     |     |     |  |  |
|  | Short-time delay  |                      | —  |    |           |    |     |     |     | —   |    |            |    |     |     |     |  |  |
|  | Instantaneous   |                      | $12 \times I_n$  |    |           |    |     |     |     | $(9-10-11-12-13-14) \times I_n$   |    |            |    |     |     |     |  |  |
| Electronic                                       | SU20S Basic type  | Long-time delay      | —  |    |           |    |     |     |     | —   |    |            |    |     |     |     |  |  |
|  | SU20C advanced type   | Instantaneous        | —  |    |           |    |     |     |     | $(1.5 \sim 14) \times I_n$  |    |            |    |     |     |     |  |  |
| Control and indication                           |   |                      |  |    |           |    |     |     |     |   |    |            |    |     |     |     |  |  |
| Control mode                                     | Manual  | Direct(RHD)          | □  |    |           |    |     |     |     | □   |    |            |    |     |     |     |  |  |
|  |   | Extended(ERH)        | □  |    |           |    |     |     |     | □   |    |            |    |     |     |     |  |  |
|  |   | Motor mechanism(MOD) | □  |    |           |    |     |     |     | □   |    |            |    |     |     |     |  |  |
| Shunt release(SHT)                               |   |                      | □  |    |           |    |     |     |     | □   |    |            |    |     |     |     |  |  |
| Under-voltage release(UVT)                       |   |                      | □  |    |           |    |     |     |     | □   |    |            |    |     |     |     |  |  |
| Auxiliary contact(AX)                            |   |                      | □  |    |           |    |     |     |     | □   |    |            |    |     |     |     |  |  |
| Alarm contact(AL)                                |   |                      | □  |    |           |    |     |     |     | □   |    |            |    |     |     |     |  |  |
| Connection and installation                      |   |                      |  |    |           |    |     |     |     |   |    |            |    |     |     |     |  |  |
| Degree of protection                             | All sides   |                      | IP40   |    |           |    |     |     |     | IP40  |    |            |    |     |     |     |  |  |
|  | Wiring terminal   |                      | IP20   |    |           |    |     |     |     | IP20  |    |            |    |     |     |     |  |  |
|  | Wiring assembly   |                      | Front/Rear   |    |           |    |     |     |     | Front/Rear  |    |            |    |     |     |     |  |  |
| Wiring   | Plug-in base(PIA)   |                      | □  |    |           |    |     |     |     | □   |    |            |    |     |     |     |  |  |
|  | Draw-out base(DOB)  |                      | —  |    |           |    |     |     |     | —   |    |            |    |     |     |     |  |  |
| Terminal shield(TCV)                             | Front   |                      | □  |    |           |    |     |     |     | □   |    |            |    |     |     |     |  |  |
|  | Rear  |                      | —  |    |           |    |     |     |     | —   |    |            |    |     |     |     |  |  |
| Key lock(KLK)                                    |   |                      | ON/OFF position  |    |           |    |     |     |     | ON/OFF position   |    |            |    |     |     |     |  |  |
| Phase shield(PHS)                                |   |                      | ■  |    |           |    |     |     |     | ■   |    |            |    |     |     |     |  |  |
| Mechanical interlock(MIT)                        |   |                      | □  |    |           |    |     |     |     | □   |    |            |    |     |     |     |  |  |
| External dimensions (mm)                         |  |                      | a(2*/3/4)  |    | 62/90/120 |    |     |     |     |   |    | 70/105/140 |    |     |     |     |  |  |
|  | W × H × D   |                      | b  |    | 140       |    |     |     |     |   |    | 157        |    |     |     |     |  |  |
| Weight (kg)                                      | 2P  |                      | 0.9  |    |           |    |     |     |     | 1.2   |    |            |    |     |     |     |  |  |
|  | Fixed before connection   |                      | 1.2  |    |           |    |     |     |     | 1.7   |    |            |    |     |     |     |  |  |
|  | 4P  |                      | 1.7  |    |           |    |     |     |     | 2.2   |    |            |    |     |     |     |  |  |



■ Standard □ Optional — None

\* only Ex9M1, Ex9M2 have 2P.



Note :Rated current of electronic MCCB, rated current of electronic Ex9M2 is 250A, 160A, 100A, 63A and 32A.

| Ex9M3M  |    |    |    |     |     |     |  | Ex9M4M  |    |    |    |     |     |     |  | Ex9M5M  |    |    |    |     |     |     |  |
|---|----|----|----|-----|-----|-----|--|---|----|----|----|-----|-----|-----|--|---|----|----|----|-----|-----|-----|--|
|  |    |    |    |     |     |     |  |  |    |    |    |     |     |     |  |  |    |    |    |     |     |     |  |
| 3P/4P<br>400  |    |    |    |     |     |     |  | 3P/4P<br>630  |    |    |    |     |     |     |  | 3P/4P<br>800  |    |    |    |     |     |     |  |
| 50/60<br>380/400/415/660/690<br>250-315-350-400                                   |    |    |    |     |     |     |  | 50/60<br>380/400/415/660/690<br>400-500-630                                       |    |    |    |     |     |     |  | 50/60<br>380/400/415/660/690<br>630-700-800   |    |    |    |     |     |     |  |
| 800   |    |    |    |     |     |     |  | 800   |    |    |    |     |     |     |  | 800   |    |    |    |     |     |     |  |
| 8   |    |    |    |     |     |     |  | 8   |    |    |    |     |     |     |  | 8   |    |    |    |     |     |     |  |
| S   | N  | Q  | R  | H   | V   | P   |  | S   | N  | Q  | R  | H   | V   | P   |  | S   | N  | Q  | R  | H   | V   | P   |  |
| 36  | 50 | 70 | 85 | 100 | 120 | 150 |  | 36  | 50 | 70 | 85 | 100 | 120 | 150 |  | 36  | 50 | 70 | 85 | 100 | 120 | 150 |  |
| 10  | 10 | 10 | 10 | 12  | 12  | 15  |  | 10  | 10 | 10 | 10 | 12  | 12  | 15  |  | 10  | 10 | 10 | 10 | 12  | 12  | 15  |  |
| 100%  |    |    |    |     |     |     |  | 100%  |    |    |    |     |     |     |  | 100%  |    |    |    |     |     |     |  |
| 50%   |    |    |    |     |     |     |  | 100%  |    |    |    |     |     |     |  | 100%  |    |    |    |     |     |     |  |
| ■   |    |    |    |     |     |     |  | ■   |    |    |    |     |     |     |  | ■   |    |    |    |     |     |     |  |
| A   |    |    |    |     |     |     |  | A   |    |    |    |     |     |     |  | A   |    |    |    |     |     |     |  |
| 10000   |    |    |    |     |     |     |  | 10000   |    |    |    |     |     |     |  | 5000  |    |    |    |     |     |     |  |
| 4000  |    |    |    |     |     |     |  | 4000  |    |    |    |     |     |     |  | 2500  |    |    |    |     |     |     |  |
| 2000  |    |    |    |     |     |     |  | 2000  |    |    |    |     |     |     |  | 1000  |    |    |    |     |     |     |  |
| 1000  |    |    |    |     |     |     |  | 1000  |    |    |    |     |     |     |  | 500   |    |    |    |     |     |     |  |
| —   |    |    |    |     |     |     |  | —   |    |    |    |     |     |     |  | —   |    |    |    |     |     |     |  |
| —   |    |    |    |     |     |     |  | —   |    |    |    |     |     |     |  | —   |    |    |    |     |     |     |  |
| (9-10-11-12-13-14)×I <sub>n</sub>   |    |    |    |     |     |     |  | (9-10-11-12-13-14)×I <sub>n</sub>   |    |    |    |     |     |     |  | (9-10-11-12-13-14)×I <sub>n</sub>   |    |    |    |     |     |     |  |
| —   |    |    |    |     |     |     |  | —   |    |    |    |     |     |     |  | —   |    |    |    |     |     |     |  |
| (1.5~14)×I <sub>n</sub>   |    |    |    |     |     |     |  | (1.5~14)×I <sub>n</sub>   |    |    |    |     |     |     |  | (1.5~14)×I <sub>n</sub>   |    |    |    |     |     |     |  |
| □   |    |    |    |     |     |     |  | □   |    |    |    |     |     |     |  | □   |    |    |    |     |     |     |  |
| □   |    |    |    |     |     |     |  | □   |    |    |    |     |     |     |  | □   |    |    |    |     |     |     |  |
| □   |    |    |    |     |     |     |  | □   |    |    |    |     |     |     |  | □   |    |    |    |     |     |     |  |
| □   |    |    |    |     |     |     |  | □   |    |    |    |     |     |     |  | □   |    |    |    |     |     |     |  |
| □   |    |    |    |     |     |     |  | □   |    |    |    |     |     |     |  | □   |    |    |    |     |     |     |  |
| □   |    |    |    |     |     |     |  | □   |    |    |    |     |     |     |  | □   |    |    |    |     |     |     |  |
| □   |    |    |    |     |     |     |  | □   |    |    |    |     |     |     |  | □   |    |    |    |     |     |     |  |
| IP40  |    |    |    |     |     |     |  | IP40  |    |    |    |     |     |     |  | IP40  |    |    |    |     |     |     |  |
| IP20  |    |    |    |     |     |     |  | IP20  |    |    |    |     |     |     |  | IP20  |    |    |    |     |     |     |  |
| Front/Rear  |    |    |    |     |     |     |  | Front/Rear  |    |    |    |     |     |     |  | Front/Rear  |    |    |    |     |     |     |  |
| □   |    |    |    |     |     |     |  | —   |    |    |    |     |     |     |  | —   |    |    |    |     |     |     |  |
| □   |    |    |    |     |     |     |  | □   |    |    |    |     |     |     |  | □   |    |    |    |     |     |     |  |
| □   |    |    |    |     |     |     |  | □   |    |    |    |     |     |     |  | □   |    |    |    |     |     |     |  |
| —   |    |    |    |     |     |     |  | —   |    |    |    |     |     |     |  | —   |    |    |    |     |     |     |  |
| ON/OFF position   |    |    |    |     |     |     |  | ON/OFF position   |    |    |    |     |     |     |  | ON/OFF position   |    |    |    |     |     |     |  |
| ■   |    |    |    |     |     |     |  | ■   |    |    |    |     |     |     |  | ■   |    |    |    |     |     |     |  |
| □   |    |    |    |     |     |     |  | □   |    |    |    |     |     |     |  | □   |    |    |    |     |     |     |  |
| 140/185   |    |    |    |     |     |     |  | 195/260   |    |    |    |     |     |     |  | 195/260   |    |    |    |     |     |     |  |
| 255   |    |    |    |     |     |     |  | 300   |    |    |    |     |     |     |  | 300   |    |    |    |     |     |     |  |
| 118.5   |    |    |    |     |     |     |  | 142   |    |    |    |     |     |     |  | 142   |    |    |    |     |     |     |  |
| —   |    |    |    |     |     |     |  | —   |    |    |    |     |     |     |  | —   |    |    |    |     |     |     |  |
| 5.0   |    |    |    |     |     |     |  | 10.2  |    |    |    |     |     |     |  | 10.2  |    |    |    |     |     |     |  |
| 6.6   |    |    |    |     |     |     |  | 13.5  |    |    |    |     |     |     |  | 13.5  |    |    |    |     |     |     |  |

## Parameters



| Ex9M Series Switch Disconnecter             |   |                      | Ex9M1SD  | Ex9M2SD   |
|---|---|----------------------|--|---|
| Switch disconnecter                         |   |                      |  |  |
| Number of poles                             |   |                      | 2P/3P/4P   | 2P/3P/4P  |
| Rated frame current (A)                     |   |                      | 125  | 250   |
| Electrical performance                      |   |                      |  |   |
| Working frequency(Hz)                       | f   |                      | 50/60  | 50/60   |
| Rated operational voltage (V)U <sub>e</sub> | AC  |                      | 380/400/415/660/690  | 380/400/415/660/690   |
|   | DC  |                      | 500/750/1000   | 500/750/1000  |
| Rated working current(A)<br>I <sub>n</sub>  | AC  |                      | 125  | 250   |
|   | DC  |                      | 125  | 250   |
| Rated insulation voltage(V)                 | U <sub>i</sub>  |                      | 1000   | 1000  |
| Rated impulse withstand voltage             | U <sub>imp</sub>  |                      | 8  | 8   |
| Rated shorttime<br>withstand current<br>(A) |   | 1s                   | 1800   | 3200  |
|   |   | 3s                   | 1800   | 3200  |
|   |   | 20s                  | 700  | 1350  |
| Isolation function                          |   |                      | ■  | ■   |
| Utilization type                            | AC  |                      | AC22A/AC23A  | AC22A/AC23A   |
|   | DC  |                      | DC22A/DC23A  | DC22A/DC23A   |
| Service life<br>(C-O)                       | Mechanical  | Actual mean value    | 15000  | 15000   |
|   |   | Test value           | 7000   | 7000  |
|   | Electrical  | Actual value         | 5000   | 5000  |
|   |   | Standard value       | 1000   | 1000  |
| Control and indication                      |   |                      |  |   |
| Control mode                                | Manual  | Direct(RHD)          | <input type="checkbox"/>   | <input type="checkbox"/>  |
|   |   | Extended(ERH)        | <input type="checkbox"/>   | <input type="checkbox"/>  |
|   |   | Motor mechanism(MOD) | <input type="checkbox"/>   | <input type="checkbox"/>  |
| Shunt release(SHT)                          |   |                      | <input type="checkbox"/>   | <input type="checkbox"/>  |
| Under-voltage release(UVT)                  |   |                      | <input type="checkbox"/>   | <input type="checkbox"/>  |
| Auxiliary contact(AX)                       |   |                      | <input type="checkbox"/>   | <input type="checkbox"/>  |
| Alarm contact(AL)                           |   |                      | <input type="checkbox"/>   | <input type="checkbox"/>  |
| Connection and installation                 |   |                      |  |   |
| Degree of protection                        | All sides   |                      | IP40   | IP40  |
|   | Wiring terminal   |                      | IP20   | IP20  |
| Wiring                                      | Wiring assembly   |                      | Front/Rear   | Front/Rear  |
|   | Plug-in base(PIA)   |                      | <input type="checkbox"/>   | <input type="checkbox"/>  |
|   | Draw-out base(DOB)  |                      | —  | —   |
| Terminal shield(TCV)                        | Front   |                      | <input type="checkbox"/>   | <input type="checkbox"/>  |
|   | Rear  |                      | —  | —   |
| Key lock(KLK)                               |   |                      | ON/OFF position  | ON/OFF position   |
| Phase shield(PHS)                           |   |                      | ■  | ■   |
| Mechanical interlock(MIT)                   |   |                      | <input type="checkbox"/>   | <input type="checkbox"/>  |
| External dimensions<br>(mm)<br>W × H × D    |  | a(2*/3/4)            | 62/90/120  | 70/105/140  |
|   |   | b                    | 140  | 157   |
|   |   | c                    | 81.6   | 91.5  |
| Weight (Kg)<br>(Fixed before connection)    | 2P  |                      | 0.6  | 1.1   |
|   | 3P  |                      | 1.0  | 1.5   |
|   | 4P  |                      | 1.5  | 2.0   |

■ standard    □ Optional    — None    \* Only Ex9M1SD, Ex9M2SD have 2 P; 500V for 2 poles in series connection, 750V for 3 poles in series connection, 1000V for 4 poles in series connection

|  | Ex9M3SD   | Ex9M4SD   | Ex9M5SD   |
|--|---|---|---|
|  |  |  |  |
|  | 3P/4P   | 3P/4P   | 3P/4P   |
|  | 400   | 630   | 800   |
|  | 50/60   | 50/60   | 50/60   |
|  | 380/400/415/660/690   | 380/400/415/660/690   | 380/400/415/660/690   |
|  | 750/1000  | 750/1000  | 750/1000  |
|  | 400   | 630   | 800   |
|  | 400   | 630   | 800   |
|  | 1000  | 1000  | 1000  |
|  | 8   | 8   | 8   |
|  | 5000  | 8000  | 10000   |
|  | 5000  | 8000  | 10000   |
|  | 2400  | 3000  | 3800  |
|  | ■   | ■   | ■   |
|  | AC22A/AC23A   | AC22A/AC23A   | AC22A/AC23A   |
|  | DC22A/DC23A   | DC22A/DC23A   | DC22A/DC23A   |
|  | 10000   | 5000  | 5000  |
|  | 4000  | 4000  | 2500  |
|  | 2000  | 2000  | 2000  |
|  | 1000  | 1000  | 500   |
|  | □   | □   | □   |
|  | □   | □   | □   |
|  | □   | □   | □   |
|  | □   | □   | □   |
|  | □   | □   | □   |
|  | □   | □   | □   |
|  | □   | □   | □   |
|  | IP40  | IP40  | IP40  |
|  | IP20  | IP20  | IP20  |
|  | Front/Rear  | Front/Rear  | Front/Rear  |
|  | □   | —   | —   |
|  | □   | □   | □   |
|  | □   | □   | □   |
|  | —   | —   | —   |
|  | ON/OFF position   | ON/OFF position   | ON/OFF position   |
|  | ■   | ■   | ■   |
|  | □   | □   | □   |
|  | 140/185   | 195/260   | 195/260   |
|  | 255   | 300   | 300   |
|  | 118.5   | 142   | 142   |
|  | —   | —   | —   |
|  | 4.5   | 9.5   | 9.5   |
|  | 6.0   | 12.7  | 12.7  |





## Parameters

| Ex9MD Series DC Circuit Breaker      |                    |   | Ex9MD1   |    |           |    |    |     | Ex9MD2  |    |            |    |    |     |  |  |
|--------------------------------------|--------------------|---|--|----|-----------|----|----|-----|---|----|------------|----|----|-----|--|--|
| For PV system                        |                    |   |  |    |           |    |    |     |  |    |            |    |    |     |  |  |
| Number of poles                      |                    |   | 2P/3P/4P   |    |           |    |    |     | 2P/3P/4P  |    |            |    |    |     |  |  |
| Rated frame current (A)              |                    |   | 125  |    |           |    |    |     | 250   |    |            |    |    |     |  |  |
| Electrical performance               |                    |   |  |    |           |    |    |     |   |    |            |    |    |     |  |  |
| Rated working voltage (V)            |                    | $U_e$   | 500/750/1000   |    |           |    |    |     | 500/750/1000  |    |            |    |    |     |  |  |
| Rated current (A)                    |                    | $I_n$   | 16-20-25-32-40-50-63-80-100-125  |    |           |    |    |     | 125-160-180-200-225-250   |    |            |    |    |     |  |  |
| Rated insulation voltage (V)         |                    | $U_i$   | 1000   |    |           |    |    |     | 1000  |    |            |    |    |     |  |  |
| Rated impulse withstand voltage (kV) |                    | $U_{imp}$   | 8  |    |           |    |    |     | 8   |    |            |    |    |     |  |  |
| Type of breaking                     |                    |   | B  | S  | N         | Q  | R  | H   | B   | S  | N          | Q  | R  | H   |  |  |
| Ultimate breaking capacity (kA)      |                    | $I_{cu}$ 1000V DC   | 25   | 36 | 50        | 70 | 85 | 100 | 25  | 36 | 50         | 70 | 85 | 100 |  |  |
| Service breaking capacity (% Icu)    |                    | $I_{cs}$  | 100%   |    |           |    |    |     | 100%  |    |            |    |    |     |  |  |
| Isolation function                   |                    |   | ■  |    |           |    |    |     | ■   |    |            |    |    |     |  |  |
| Utilization category                 |                    |   | A  |    |           |    |    |     | A   |    |            |    |    |     |  |  |
| Service life<br>(C-O cycle)          | Mechanical         | Actual mean value   | 15000  |    |           |    |    |     | 15000   |    |            |    |    |     |  |  |
|                                      |                    | Test value  | 7000   |    |           |    |    |     | 7000  |    |            |    |    |     |  |  |
|                                      | Electrical         | Actual value  | 5000   |    |           |    |    |     | 5000  |    |            |    |    |     |  |  |
|                                      |                    | Standard value  | 1000   |    |           |    |    |     | 1000  |    |            |    |    |     |  |  |
| Protection                           |                    |   |  |    |           |    |    |     |   |    |            |    |    |     |  |  |
| Thermomagnetic                       |                    | Long-time delay   | $(0.8-0.9-1.0) \times I_n$   |    |           |    |    |     | $(0.8-0.9-1.0) \times I_n$  |    |            |    |    |     |  |  |
|                                      |                    | Short-time delay  | —  |    |           |    |    |     | —   |    |            |    |    |     |  |  |
|                                      |                    | Instantaneous   | $10 \times I_n$  |    |           |    |    |     | $(5-6-7-8-9-10) \times I_n$   |    |            |    |    |     |  |  |
| Control and indication               |                    |   |  |    |           |    |    |     |   |    |            |    |    |     |  |  |
| Control mode                         | Manual             | Direct(RHD)   | □  |    |           |    |    |     | □   |    |            |    |    |     |  |  |
|                                      |                    | Extended(ERH)   | □  |    |           |    |    |     | □   |    |            |    |    |     |  |  |
|                                      |                    | Motor mechanism(MOD)  | □  |    |           |    |    |     | □   |    |            |    |    |     |  |  |
| Shunt release(SHT)                   |                    |   | □  |    |           |    |    |     | □   |    |            |    |    |     |  |  |
| Under-voltage release(UVT)           |                    |   | □  |    |           |    |    |     | □   |    |            |    |    |     |  |  |
| Auxiliary contact(AX)                |                    |   | □  |    |           |    |    |     | □   |    |            |    |    |     |  |  |
| Alarm contact(AL)                    |                    |   | □  |    |           |    |    |     | □   |    |            |    |    |     |  |  |
| Connection and installation          |                    |   |  |    |           |    |    |     |   |    |            |    |    |     |  |  |
| Degree of protection                 |                    | All sides   | IP40   |    |           |    |    |     | IP40  |    |            |    |    |     |  |  |
|                                      |                    | Wiring terminal   | IP20   |    |           |    |    |     | IP20  |    |            |    |    |     |  |  |
|                                      |                    | Wiring assembly   | Front/rear   |    |           |    |    |     | Front/rear  |    |            |    |    |     |  |  |
| Wiring                               | Plug-in base(PIA)  |   | □  |    |           |    |    |     | □   |    |            |    |    |     |  |  |
|                                      | Draw-out base(DOB) |   | —  |    |           |    |    |     | —   |    |            |    |    |     |  |  |
|                                      | Shorted row(DCB)   |   | ■  |    |           |    |    |     | ■   |    |            |    |    |     |  |  |
| Key lock(KLK)                        |                    |   | ON/OFF position  |    |           |    |    |     | ON/OFF position   |    |            |    |    |     |  |  |
| Phase shield(PHS)                    |                    |   | ■  |    |           |    |    |     | ■   |    |            |    |    |     |  |  |
| Mechanical interlock(MIT)            |                    |   | □  |    |           |    |    |     | □   |    |            |    |    |     |  |  |
| External dimensions (mm)             |                    |  | $a(2^*/3/4)$   |    | 62/90/120 |    |    |     |   |    | 70/105/140 |    |    |     |  |  |
| W × H × D                            |                    |   | b  |    | 140       |    |    |     |   |    | 157        |    |    |     |  |  |
|                                      |                    |   | c  |    | 81.6      |    |    |     |   |    | 91.5       |    |    |     |  |  |
| Weight (kg)                          |                    | 2P  | 0.9  |    |           |    |    |     | 1.2   |    |            |    |    |     |  |  |
| (Fixed before connection)            |                    | 3P  | 1.2  |    |           |    |    |     | 1.7   |    |            |    |    |     |  |  |
|                                      |                    | 4P  | 1.7  |    |           |    |    |     | 2.2   |    |            |    |    |     |  |  |

■ standard □ Optional — None

\* Only Ex9MD1 Ex9MD2 have 2 P; 500V for 2 poles in series connection, 750V for 3 poles in series connection, 1000V for 4 poles in series connection



| Ex9MD3  |    |    |    |    |     |  | Ex9MD4  |    |    |    |    |     | Ex9MD5  |    |    |    |    |     |
|---|----|----|----|----|-----|--|---|----|----|----|----|-----|---|----|----|----|----|-----|
|  |    |    |    |    |     |  |  |    |    |    |    |     |  |    |    |    |    |     |
| 3P/4P   |    |    |    |    |     |  | 3P/4P   |    |    |    |    |     | 3P/4P   |    |    |    |    |     |
| 400   |    |    |    |    |     |  | 630   |    |    |    |    |     | 800   |    |    |    |    |     |
| 750/1000  |    |    |    |    |     |  | 750/1000  |    |    |    |    |     | 750/1000  |    |    |    |    |     |
| 250-315-350-400   |    |    |    |    |     |  | 400-500-630   |    |    |    |    |     | 630-700-800   |    |    |    |    |     |
| 1000  |    |    |    |    |     |  | 1000  |    |    |    |    |     | 1000  |    |    |    |    |     |
| 8   |    |    |    |    |     |  | 8   |    |    |    |    |     | 8   |    |    |    |    |     |
| B   | S  | N  | Q  | R  | H   |  | B   | S  | N  | Q  | R  | H   | B   | S  | N  | Q  | R  | H   |
| 25  | 36 | 50 | 70 | 85 | 100 |  | 25  | 36 | 50 | 70 | 85 | 100 | 25  | 36 | 50 | 70 | 85 | 100 |
| 100%  |    |    |    |    |     |  | 100%  |    |    |    |    |     | 100%  |    |    |    |    |     |
| ■   |    |    |    |    |     |  | ■   |    |    |    |    |     | ■   |    |    |    |    |     |
| A   |    |    |    |    |     |  | A   |    |    |    |    |     | A   |    |    |    |    |     |
| 10000   |    |    |    |    |     |  | 10000   |    |    |    |    |     | 5000  |    |    |    |    |     |
| 4000  |    |    |    |    |     |  | 4000  |    |    |    |    |     | 2500  |    |    |    |    |     |
| 2000  |    |    |    |    |     |  | 2000  |    |    |    |    |     | 1000  |    |    |    |    |     |
| 1000  |    |    |    |    |     |  | 1000  |    |    |    |    |     | 500   |    |    |    |    |     |
| (0.8-0.9-1.0)×I <sub>n</sub>  |    |    |    |    |     |  | (0.8-0.9-1.0)×I <sub>n</sub>  |    |    |    |    |     | (0.8-0.9-1.0)×I <sub>n</sub>  |    |    |    |    |     |
| —   |    |    |    |    |     |  | —   |    |    |    |    |     | —   |    |    |    |    |     |
| (5-6-7-8-9-10)×I <sub>n</sub>   |    |    |    |    |     |  | (5-6-7-8-9-10)×I <sub>n</sub>   |    |    |    |    |     | (5-6-7-8-9-10)×I <sub>n</sub>   |    |    |    |    |     |
| □   |    |    |    |    |     |  | □   |    |    |    |    |     | □   |    |    |    |    |     |
| □   |    |    |    |    |     |  | □   |    |    |    |    |     | □   |    |    |    |    |     |
| □   |    |    |    |    |     |  | □   |    |    |    |    |     | □   |    |    |    |    |     |
| □   |    |    |    |    |     |  | □   |    |    |    |    |     | □   |    |    |    |    |     |
| □   |    |    |    |    |     |  | □   |    |    |    |    |     | □   |    |    |    |    |     |
| □   |    |    |    |    |     |  | □   |    |    |    |    |     | □   |    |    |    |    |     |
| □   |    |    |    |    |     |  | □   |    |    |    |    |     | □   |    |    |    |    |     |
| IP40  |    |    |    |    |     |  | IP40  |    |    |    |    |     | IP40  |    |    |    |    |     |
| IP20  |    |    |    |    |     |  | IP20  |    |    |    |    |     | IP20  |    |    |    |    |     |
| Front/rear  |    |    |    |    |     |  | Front/rear  |    |    |    |    |     | Front/rear  |    |    |    |    |     |
| □   |    |    |    |    |     |  | —   |    |    |    |    |     | —   |    |    |    |    |     |
| □   |    |    |    |    |     |  | □   |    |    |    |    |     | □   |    |    |    |    |     |
| ■   |    |    |    |    |     |  | ■   |    |    |    |    |     | ■   |    |    |    |    |     |
| ON/OFF position   |    |    |    |    |     |  | ON/OFF position   |    |    |    |    |     | ON/OFF position   |    |    |    |    |     |
| ■   |    |    |    |    |     |  | ■   |    |    |    |    |     | ■   |    |    |    |    |     |
| □   |    |    |    |    |     |  | □   |    |    |    |    |     | □   |    |    |    |    |     |
| 140/185   |    |    |    |    |     |  | 195/260   |    |    |    |    |     | 195/260   |    |    |    |    |     |
| 255   |    |    |    |    |     |  | 300   |    |    |    |    |     | 300   |    |    |    |    |     |
| 118.5   |    |    |    |    |     |  | 142   |    |    |    |    |     | 142   |    |    |    |    |     |
| —   |    |    |    |    |     |  | —   |    |    |    |    |     | —   |    |    |    |    |     |
| 5.0   |    |    |    |    |     |  | 10.2  |    |    |    |    |     | 10.2  |    |    |    |    |     |
| 6.6   |    |    |    |    |     |  | 13.5  |    |    |    |    |     | 13.5  |    |    |    |    |     |

## Appearance



CB



CE

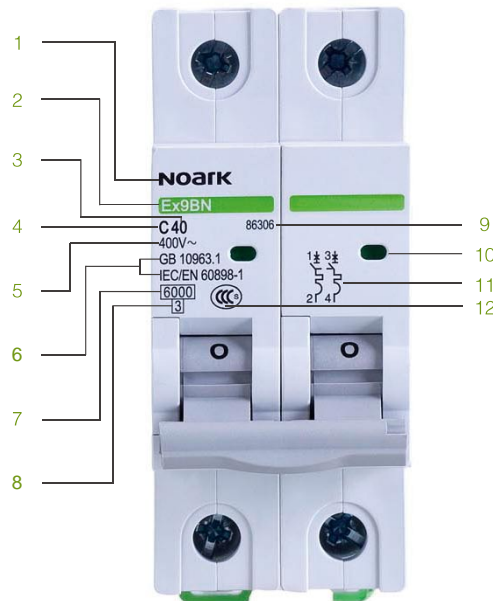

- 1 Brand
- 2 Type
- 3 Rated current
- 4 Tripping type
- 5 Rated voltage
- 6 Conformed Standards
- 7 Rated breaking capacity
- 8 Level of current limiting
- 9 Ordering code
- 10 Indicator
- 11 Electrical diagram
- 12 Signal of certificates

## Characteristics

### Instantaneous tripping type

- Curve B

Protection for pure resistance load and low inductive illuminating system  
Rated current: 1-63A(30 C)  
Tripping characteristic:  
instantaneous tripping range(3-5)I<sub>n</sub>

- Curve C

Protection for inductive load and high inductive illuminating system.  
Rated current: 1-63A(30 C)  
Tripping characteristic:  
instantaneous tripping range(5-10)I<sub>n</sub>

- Curve D

Protection for high inductive load and high inrush current when starting(such as motor and transformer)  
Rated current: 1-63A(30 C)  
Tripping characteristic:  
instantaneous tripping range(10-14)I<sub>n</sub>  
Tripping characteristic:  
instantaneous tripping range(3-5)I<sub>n</sub>

### Conformed standard

IEC/EN60898-1

## Ordering

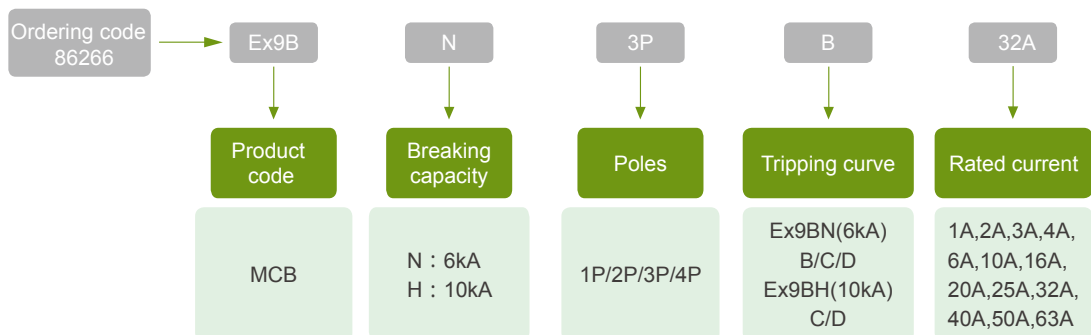



## Parameters

| MCB Ex9B  |   |                |                                   |      |      |    |
|---|---|----------------|-----------------------------------|------|------|----|
| For protection of general power distribution (IEC/EN 60898-1) |   |                |                                   |      |      |    |
| Poles   |   | 1P             | 2P                                | 3P   | 4P   |    |
| Electrical performance  |   |                |                                   |      |      |    |
| Functions   | short circuit protection, overload protection, isolation, control |                |                                   |      |      |    |
| Rated frequency   | f   | Hz             | 50/60                             |      |      |    |
| Rated working voltage   | U <sub>e</sub>  | V AC           | 230/400                           |      |      |    |
| Rated current   | I <sub>n</sub>  | A              | 1,2,3,4,6,10,16,20,25,32,40,50,63 |      |      |    |
| Rated insulated voltage                                       | U <sub>i</sub>  | V              | 690                               |      |      |    |
| Impulse withstand voltage                                     | U <sub>imp</sub>  | kV             | 4                                 |      |      |    |
| Current limiting level  | 3   |                |                                   |      |      |    |
| Instantaneous tripping type                                   | Ex9BN   | B/C/D          |                                   |      |      |    |
|   | Ex9BH   | C/D            |                                   |      |      |    |
| Rated short circuit I <sub>cn</sub> (kA)                      | Ex9BN   | 6              |                                   |      |      |    |
|   | Ex9BH   | 10             |                                   |      |      |    |
| Release type  | Thermal magnetic type   |                |                                   |      |      |    |
| Service life (O~C)  | Mechanical  | Actual value   | 20000                             |      |      |    |
|   |   | Standard value | 4000                              |      |      |    |
|   | Electrical  | Actual value   | 10000                             |      |      |    |
|   |   | Standard value | 4000                              |      |      |    |
| Control and indication  |   |                |                                   |      |      |    |
| Auxiliary contact   | <input type="checkbox"/>  |                |                                   |      |      |    |
| Alarm contact   | <input type="checkbox"/>  |                |                                   |      |      |    |
| Shunt release   | <input type="checkbox"/>  |                |                                   |      |      |    |
| Undervoltage release  | <input type="checkbox"/>  |                |                                   |      |      |    |
| Overvoltage release   | <input type="checkbox"/>  |                |                                   |      |      |    |
| Connection and installation                                   |   |                |                                   |      |      |    |
| Protection degree   | IP20  |                |                                   |      |      |    |
| Padlock   | ON/OFF position   |                |                                   |      |      |    |
| Wire  | mm <sup>2</sup>   | 1~35           |                                   |      |      |    |
| Working temperature   | -30~+70   |                |                                   |      |      |    |
| Resistance to humidity and heat                               | Class 2   |                |                                   |      |      |    |
| Altitude above sea  | m   | ≤2000          |                                   |      |      |    |
| Relative humidity   | +20 , ≤95% ; +40 , ≤50%   |                |                                   |      |      |    |
| Pollution degree  | 2   |                |                                   |      |      |    |
| Installation environment                                      | Avoid obvious shock and vibration                                 |                |                                   |      |      |    |
| Installation class  | Class III   |                |                                   |      |      |    |
| Mounting  | DIN35 rail  |                |                                   |      |      |    |
| Dimensions(mm)<br>(WxHxL)                                     |   | a              | 18                                | 36   | 54   | 72 |
|   |   | b              | 89                                | 89   | 89   | 89 |
|   |   | c              | 72                                | 74   | 74   | 74 |
| Weight  | kg  | 0.12           | 0.24                              | 0.36 | 0.48 |    |

■ Standard    □ Optional    — None

## Appearance

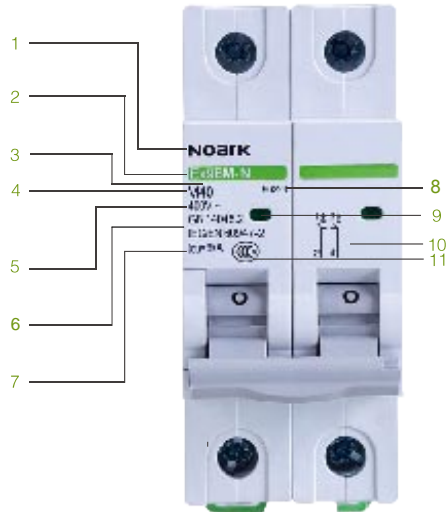

- 1 Brand
- 2 Type
- 3 Rated current
- 4 Tripping type
- 5 Rated voltage
- 6 Conformed Standards
- 7 Rated breaking capacity
- 8 Ordering code
- 9 Indicator
- 10 Electrical diagram
- 11 Signal of certificates

## Characteristics

### Instantaneous tripping type

- Curve M

Apply to medical, IT power distribution systems, motor protection and building fire systems, etc

Rated current: 1-63A (30 )

Tripping characteristic: instantaneous tripping range (9.6 ~ 14.4)In

\* For the detail of tripping curve, please refer to appendix

### Conformed standards

IEC / EN60947-2

\* Ex9BM must be used together with thermal relay or motor starter to achieve the purpose of overload protection

## Selection Guide

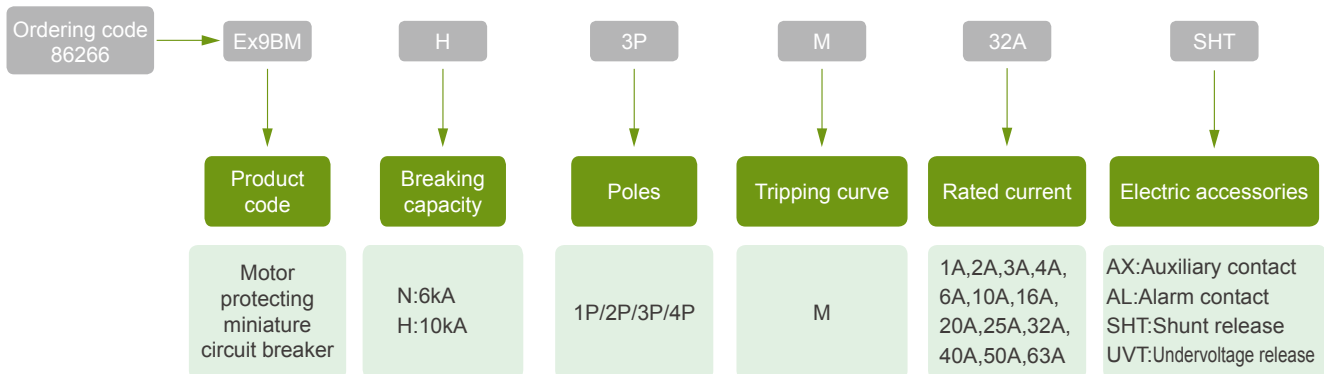



## Parameters

| MCB Ex9BM                                   |  |                |                                   |      |      |    |
|---|--|----------------|-----------------------------------|------|------|----|
| For protection of motor<br>(IEC/EN 60947-2) |  |                |                                   |      |      |    |
| Poles                                       |  | 1P             | 2P                                |      |      |    |
| Electrical specification                    |  |                |                                   |      |      |    |
| Functions                                   | short circuit protection, isolation, control |                |                                   |      |      |    |
| Rated frequency                             | f  | Hz             | 50/60                             |      |      |    |
| Rated working voltage                       | $U_e$  | V AC           | 230/400                           |      |      |    |
| Rated current                               | $I_n$  | A              | 1,2,3,4,6,10,16,20,25,32,40,50,63 |      |      |    |
| Rated insulated voltage                     | $U_i$  | V              | 690                               |      |      |    |
| Impulse withstand voltage                   | $U_{imp}$                                    | kV             | 4                                 |      |      |    |
| Instantaneous tripping type                 | M  |                |                                   |      |      |    |
| Rated short circuit $I_{cn}$ (kA)           | Ex9BM-N                                      |                | 6                                 |      |      |    |
|   | Ex9BM-H                                      |                | 10                                |      |      |    |
| Release type                                | Thermal magnetic type                        |                |                                   |      |      |    |
| Service life (O~C)                          | Mechanical                                   | Actual value   | 20000                             |      |      |    |
|   |  | Standard value | 8500                              |      |      |    |
|   | Electrical                                   | Actual value   | 10000                             |      |      |    |
|   |  | Standard value | 1500                              |      |      |    |
| Control and indication                      |  |                |                                   |      |      |    |
| Auxiliary contact                           | <input type="checkbox"/>                     |                |                                   |      |      |    |
| Alarm contact                               | <input type="checkbox"/>                     |                |                                   |      |      |    |
| Shunt release                               | <input type="checkbox"/>                     |                |                                   |      |      |    |
| Undervoltage release                        | <input type="checkbox"/>                     |                |                                   |      |      |    |
| Overvoltage release                         | <input type="checkbox"/>                     |                |                                   |      |      |    |
| Connection and installation                 |  |                |                                   |      |      |    |
| Protection degree                           | IP20   |                |                                   |      |      |    |
| Padlock                                     | ON/OFF position                              |                |                                   |      |      |    |
| Wire  | mm <sup>2</sup>                              | 1~35           |                                   |      |      |    |
| Working temperature                         | -30~+70                                      |                |                                   |      |      |    |
| Resistance to humidity and heat             | Class 2                                      |                |                                   |      |      |    |
| Altitude above sea                          | m  | ≤2000          |                                   |      |      |    |
| Relative humidity                           | +20 , ≤95%, +40 , ≤50%                       |                |                                   |      |      |    |
| Pollution degree                            | 2  |                |                                   |      |      |    |
| Installation environment                    | Avoid obvious shock and vibration            |                |                                   |      |      |    |
| Installation class                          | Class III                                    |                |                                   |      |      |    |
| Mounting                                    | DIN35 rail                                   |                |                                   |      |      |    |
| Dimensions(mm)<br>(WxHxL)                   |  | a              | 18                                | 36   | 54   | 72 |
|   |  | b              | 89                                | 89   | 89   | 89 |
|   |  | c              | 72                                | 74   | 74   | 74 |
| Weight                                      | kg   | 0.12           | 0.24                              | 0.36 | 0.48 |    |

■ Default    □ Optional    — None

## Appearance



CB

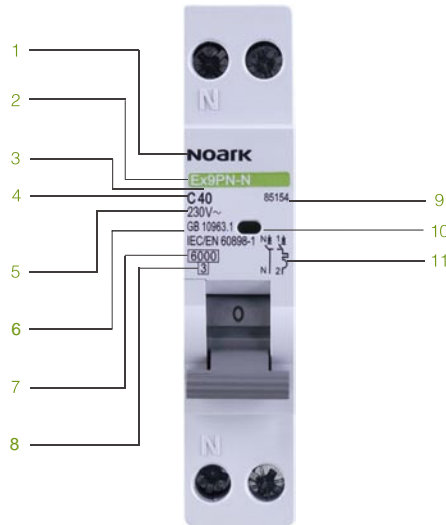

- 1 Brand
- 2 Type
- 3 Rated current
- 4 Tripping type
- 5 Rated voltage
- 6 Conformed Standards
- 7 Rated breaking capacity
- 8 Level of current limiting
- 9 Ordering code
- 10 Indicator
- 11 Electrical diagram

## Characteristics

### Instantaneous tripping type

- Curve B  
Protection for pure resistance load and low inductive illuminating system.  
Rated current: 1~40A(30°C)  
Tripping characteristic:  
instantaneous tripping range(3-5)In
- Curve C  
Protection for inductive load and high inductive illuminating system.  
Rated current: 1~40A(30°C)  
Tripping characteristic:  
instantaneous tripping range(5-10)In

\* For the detail of tripping curve, please refer to appendix

### Conformed standards

IEC / EN60898-1

## Selection Guide

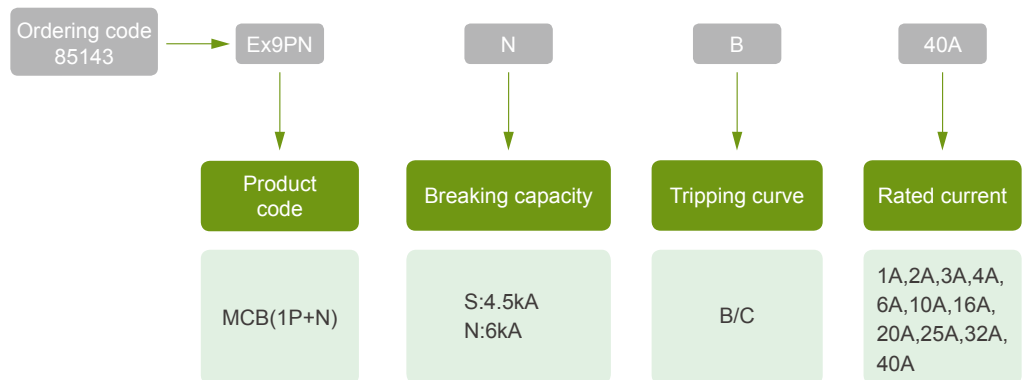

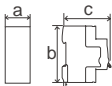

## Parameters

| MCB Ex9PN  |   |   |                             |
|--|---|---|-----------------------------|
| For protection of general power distribution<br>( IEC/EN 60898-1 ) |   |  |                             |
| Poles  |   | 1P+N  |                             |
| Electrical performance   |   |   |                             |
| Functions  |   | short circuit protection, overload protection, isolation, control                   |                             |
| Rated frequency  | f   | Hz  | 50/60                       |
| Rated working voltage  | U <sub>e</sub>  | V AC  | 230                         |
| Rated current  | I <sub>n</sub>  | A   | 1,2,3,4,6,10,16,20,25,32,40 |
| Rated insulated voltage  | U <sub>i</sub>  | V   | 400                         |
| Impulse withstand voltage  | U <sub>imp</sub>  | kV  | 4                           |
| Current limiting level   |   | 3   |                             |
| Instantaneous tripping type  | Ex9PN-S   |   | B/C                         |
|  | Ex9PN-N   |   | B/C                         |
| Rated short circuit I <sub>cn</sub> (kA)                           | Ex9PN-S   |   | 4.5                         |
|  | Ex9PN-N   |   | 6                           |
| Release type   |   | Thermal magnetic type   |                             |
| Service life (O~C)   | Mechanical  | Actual value  | 20000                       |
|  |   | Standard value  | 4000                        |
|  | Electrical  | Actual value  | 10000                       |
|  |   | Standard value  | 4000                        |
| Control and indication   |   |   |                             |
| Auxiliary contact  |   | <input type="checkbox"/>  |                             |
| Alarm contact  |   | <input type="checkbox"/>  |                             |
| Shunt release  |   | <input type="checkbox"/>  |                             |
| Undervoltage release   |   | <input type="checkbox"/>  |                             |
| Overvoltage release  |   | <input type="checkbox"/>  |                             |
| Connection and installation  |   |   |                             |
| Protection degree  |   | IP20  |                             |
| Padlock  |   | ON/OFF position   |                             |
| Wire   | mm <sup>2</sup>   | 1~16  |                             |
| Working temperature  |   | -30~+70   |                             |
| Resistance to humidity and heat                                    |   | Class 2   |                             |
| Altitude above sea   | m   | ≤2000   |                             |
| Relative humidity  |   | +20 , ≤95%, +40 , ≤50%  |                             |
| Pollution degree   |   | 2   |                             |
| Installation environment   |   | Avoid obvious shock and vibration   |                             |
| Installation class   |   | Class III   |                             |
| Mounting   |   | DIN35 rail  |                             |
| Dimensions(mm)<br>(WxHxL)  |  | a   | 18                          |
|  |   | b   | 89                          |
|  |   | c   | 72                          |
| Weight   | kg  | 0.12  |                             |

■ Standard    □ Optional    — None

## Appearance



CB



CE

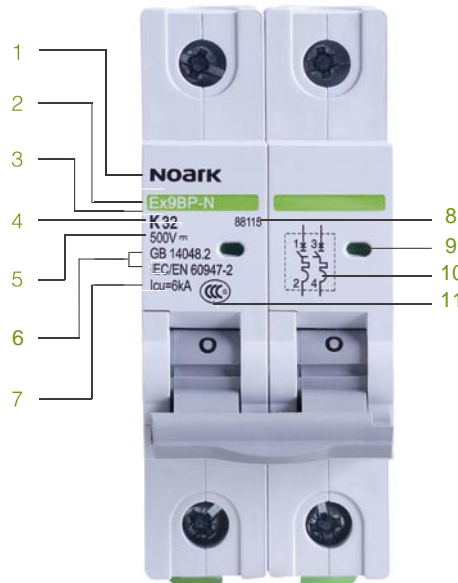

- 1 Brand
- 2 Type
- 3 Rated current
- 4 Tripping type
- 5 Rated voltage
- 6 Conformed Standards
- 7 Rated breaking capacity
- 8 Ordering code
- 9 Indicator
- 10 Electrical diagram
- 11 Signal of certificate

## Characteristics

### Instantaneous tripping type

Curve C

- Protection for low PV module perceptual load and photovoltaic line system  
Rated current: 1~63A(30 )  
Tripping characteristic:  
instantaneous tripping range(7-14) $I_n$

Curve K

- Protection for high PV module perceptual load and photovoltaic line system, and have a higher impact resistant current ability  
Tripping characteristic:  
instantaneous tripping range(14-20) $I_n$   
\* For the detail of tripping curve, please refer to appendix

### Features

The product can realize non-polarity wiring, and ensure the safety of equipment

### Conformed standards

IEC / EN60898-1

### Altitude

Ex9BP Series products have passed the high-altitude test and the test data are as follows.

| Altitude(m)  | 2000     | 3000        | 4000        | 5000       |
|--|----------|-------------|-------------|------------|
| Dielectric(V DC)                                   | 3110     | 2799        | 2550.2      | 2332.5     |
| Max working voltage for 4P tandem connection (VDC) | 1000     | 900         | 820         | 750        |
| 40 thermal rating(A)                               | 1× $I_n$ | 0.96× $I_n$ | 0.93× $I_n$ | 0.9× $I_n$ |
| Rated impulse withstand voltage $U_{imp}(kV)$      | 4        | 3.6         | 3           | 2.2        |



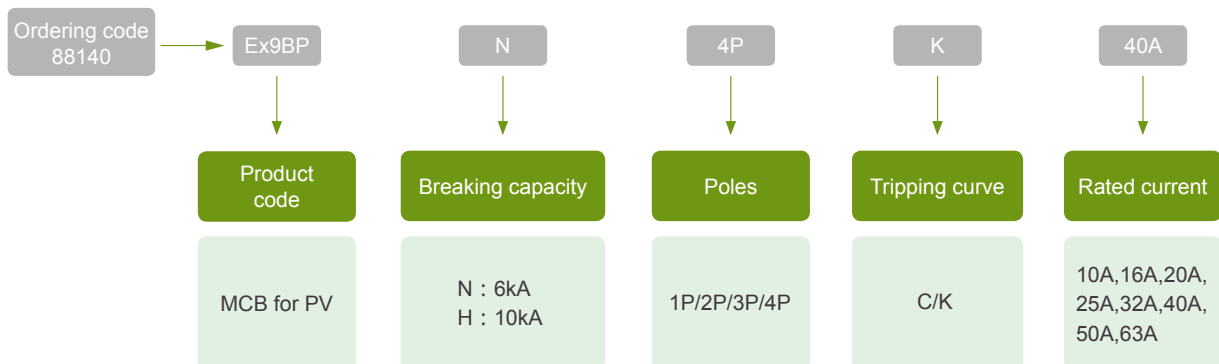

## Selection Guide





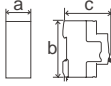

## Parameters

| MCB Ex9BP for PV                       |   |   |   |   |   |      |
|--|---|---|---|---|---|------|
| For PV system only<br>(IEC/EN 60947-2) |   |  |  |  |  |      |
| Poles                                  |   | 1P  | 2P  | 3P  | 4P  |      |
| Rated frame current (A)                |   | 63  |   |   |   |      |
| Electrical performance                 |   |   |   |   |   |      |
| Rated working voltage                  | $U_e$   | V DC  | 250   | 500   | 750   | 1000 |
| Rated current                          | $I_n$   | A   | 10,16,20,25,32,40,50,63   |   |   |      |
| Rated insulated voltage                | $U_i$   | V   | 1000  |   |   |      |
| Rated implused voltage                 | $U_{imp}$   | kV  | 4   |   |   |      |
| Type of breaking                       |   | N/H   |   |   |   |      |
| Ultimate breaking capacity             |   | kA  | 6/10  |   |   |      |
| Service breaking capacity (%Icu)       |   | 100%  |   |   |   |      |
| Curve type                             |   | C/K   |   |   |   |      |
| Tripping type                          |   | Thermal magnetic type   |   |   |   |      |
| Service life (C-O)                     | Mechanica   | Actual value  | 20000   |   |   |      |
|  |   | Standard value  | 8500  |   |   |      |
|  | Electrical  | Actual value  | 10000   |   |   |      |
|  |   | Standard value  | 1500  |   |   |      |
| Control and indication                 |   |   |   |   |   |      |
| Auxiliary contact                      |   | <input type="checkbox"/>  |   |   |   |      |
| Alarm contact                          |   | <input type="checkbox"/>  |   |   |   |      |
| Shunt release                          |   | <input type="checkbox"/>  |   |   |   |      |
| Undervoltage release                   |   | <input type="checkbox"/>  |   |   |   |      |
| Overvoltage release                    |   | <input type="checkbox"/>  |   |   |   |      |
| Connection and installation            |   |   |   |   |   |      |
| Protection degree                      |   | All sides   | IP40  |   |   |      |
|  |   | Connection terminal   | IP20  |   |   |      |
| Padlock                                |   | ON/OFF position   |   |   |   |      |
| Wire                                   |   | mm <sup>2</sup>   | 1~35  |   |   |      |
| Working temperature                    |   | -30~+70   |   |   |   |      |
| Resistance to humidity and heat        |   | Class 2   |   |   |   |      |
| Altitude above sea                     |   | m   | ≤2000   |   |   |      |
| Relative humidity                      |   | +20 , ≤95% ; +40 , ≤50%   |   |   |   |      |
| Pollution degree                       |   | 3   |   |   |   |      |
| Installation environment               |   | Avoid obvious shock and vibration   |   |   |   |      |
| Installation class                     |   | Class III   |   |   |   |      |
| Mounting                               |   | DIN35 rail  |   |   |   |      |
| Dimensions(mm)<br>(WxHxL)              |  | a   | 18  | 36  | 54  | 72   |
|  |   | b   | 89  | 89  | 89  | 89   |
|  |   | c   | 72  | 74  | 74  | 74   |
| Weight                                 |   | kg  | 0.12  | 0.24  | 0.36  | 0.48 |

■ Standard   □ Optional   — None

## Overview

### Ex9B/Ex9PN/Ex9BP have five kinds of accessories

- Alarm contact AL3111/AXL31

Function  
When MCB trips because of faults, the mechanical indicator on the panel can indicate the fault trip. AXL31 has the function of auxiliary and alarm also.

- Auxiliary contact AX3111/AX3122

Function  
To indicate ON or OFF status of the circuit breaker

- Shunt release SHT31/SHT3111

Function  
SHT should be combined with MCB to realize the function of remote trip.

- Undervoltage release UVT31/ UVT3101/UVT3110

Function  
UVT should be combined with MCB to realize the following function: When the voltage decrease to 70%-35%U<sub>e</sub>, the release make the breaker trip; only when the voltage resume to 85%-110%U<sub>e</sub>, it ensures the breaker ON

- Overvoltage release OVT31

Function  
When the voltage ranges to 280V ±5% for fault or some other reasons, overvoltage release make the circuit breaker disconnect; Overvoltage release can be used together with undervoltage release to provide comprehensive protection.

### Technical specifications

Rated current of AL31/AXL31/AX31:

|    | working voltage(V) | rated current(A) |
|----|--------------------|------------------|
| AC | 240                | 6                |
|    | 415                | 3                |
| DC | 24                 | 6                |
|    | 48                 | 2                |
|    | 130                | 1                |

### Conformed standards

IEC/EN 60947-1  
IEC/EN 60947-5-1

### Assembly of MCB and accessories



### Introduction

- Full range of accessories, realize the function of remote monitoring
- Modular design and convenient installation
- The special design makes it easy to realize the function
- Each MCB can be assembled with 2 release, 3 indicating accessories with 1 group of contact or 2 indicating accessories with 2 release accessories

## Appearance

CB

CE

EIC

SAA  
APPROVALS®



- Residual Current Circuit Breakers according to IEC / EN 61008-1
- Conditional rated short circuit strength  $I_{cn}$  6kA, 10kA
- 2 and 4-pole versions
- Rated residual current 30, 100, 300 mA
- Rated current up to 100 A
- Suitable for domestic as well as industrial applications
- AC, A, S and S+A types Rated

## Characteristics

Rated operational voltage 230/400 V AC

Rated frequency 50/60 Hz

Ex9CL residual current circuit breakers are based on permanent magnet principle. It brings the advantage of Voltage independent function. Nonzero Voltage is only necessary when testing of the RCCB with the T test button. Magnetic RCCBs should be tested regularly with a period of one month.

## Selection Guide

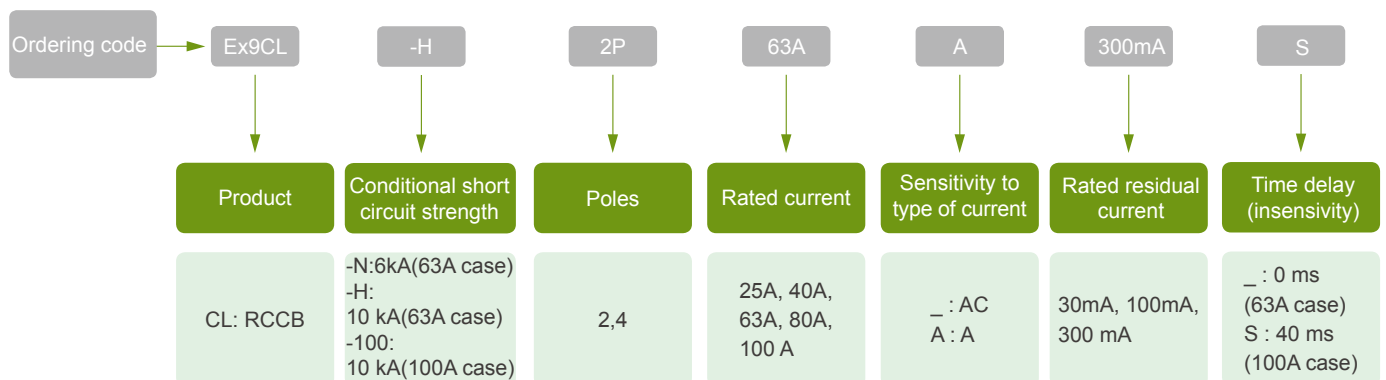



## Parameters

| Electrical parameters   | Ex9CL-H  | Ex9CL-100                                 | Ex9CL-N                             |
|---|--|---|-------------------------------------|
| Tested according to   | IEC/EN 61008   |   |                                     |
| Rated op. voltage U <sub>e</sub>  | 230/400 V AC   |   | 240/415V AC                         |
| Min. voltage for RCD function   | voltage independent  |   |                                     |
| Voltage range of the test button T  | 150 — 254 V AC (2-pole), 150 — 440 V AC (4-pole)                               |   |                                     |
| Rated frequency   | 50/60 Hz   |   | 50 Hz                               |
| Conditional short circuit strength I <sub>nc</sub>                                    | 10 kA  |   | 6 kA                                |
| Rated current   | 25, 40, 63 A   | 60,80,100                                 | 25, 40, 63                          |
| Rated residual current  | 30, 100, 300 mA  | 100, 300 mA                               | 30, 300 mA                          |
| Sensitivity to residual current   | AC type - AC residual current<br>A type - residual AC and pulsating DC current |   | AC type - AC residual current       |
| Time characteristic   | undelayed type   | selective S type with insensitivity 40 ms | undelayed type                      |
| Rated impulse withstand voltage U <sub>imp</sub>                                      | 6 kV   |   |                                     |
| Rated insulation voltage U <sub>i</sub>   | 500 V  |   |                                     |
| Mechanical service life   | 2 000 operation cycles   |   |                                     |
| Electrical service life   | 2 000 operation cycles   |   |                                     |
| Back-up fuse for overload   | I <sub>n</sub> = 25, A max. 25 A gG  | I <sub>n</sub> = 63, A max.40 A gG        | I <sub>n</sub> = 25, A max. 25 A gG |
|   | I <sub>n</sub> = 40, A max. 25 A gG  | I <sub>n</sub> = 80, A max. 50 A gG       | I <sub>n</sub> = 40, A max. 25 A gG |
|   | I <sub>n</sub> = 63, A max. 40 A gG  | I <sub>n</sub> = 100, A max. 63 A gG      | I <sub>n</sub> = 63, A max. 40 A gG |
| <b>Back-up fuse for short circuit</b>   |  |   |                                     |
| Back-up fuse for short circuit  | I <sub>n</sub> = 25, max. 63 A gG  | I <sub>n</sub> = 63, max. 63 A gG         | I <sub>n</sub> = 25, max. 63 A gG   |
|   | I <sub>n</sub> = 40, max. 63 A gG  | I <sub>n</sub> = 80, max. 80 A gG         | I <sub>n</sub> = 40, max. 63 A gG   |
|   | I <sub>n</sub> = 63, max. 63 A gG  | I <sub>n</sub> =100, max. 100 A gG        | I <sub>n</sub> = 63, max. 63 A gG   |
| Rated making capacity I <sub>m</sub> (rated residual making capacity I <sub>m</sub> ) | I <sub>n</sub> = 25,500A   | I <sub>n</sub> = 63,500A                  | I <sub>n</sub> = 25,500A            |
|   | I <sub>n</sub> = 25,500A   | I <sub>n</sub> = 80,500A                  | I <sub>n</sub> = 25,500A            |
|   | I <sub>n</sub> = 25,630A   | I <sub>n</sub> = 100,630A                 | I <sub>n</sub> = 25,630A            |
| Line voltage connection   | arbitrary above or below   |   |                                     |

## Appearance

CB

CE

IEC

SAA  
 APPROVALS®



- Residual Current Breakers with Overload protection according to IEC / EN 61009
- Rated breaking capacity Icn 6 kA
- 1+N-pole version
- Rated residual current 30 mA
- Rated currents up to 40 A
- Tripping characteristics of installed circuit breaker B and C
- Suitable for domestic as well as industrial applications
- AC and A type of RCD
- 2-module width

## Characteristics

Rated operational voltage 230/400 V AC

Rated frequency 50/60 Hz

Ex9CBL residual current circuit breakers are based on combination of residual current device with permanent magnet principle and circuit breaker with thermal overload release and magnetic short circuit current release. It brings the advantage of Voltage independent function of the residual current device. Nonzero Voltage is only necessary when testing of the RCD with the T test button. Magnetic RCDs should be tested regularly with a period of one month.

## Selection Guide

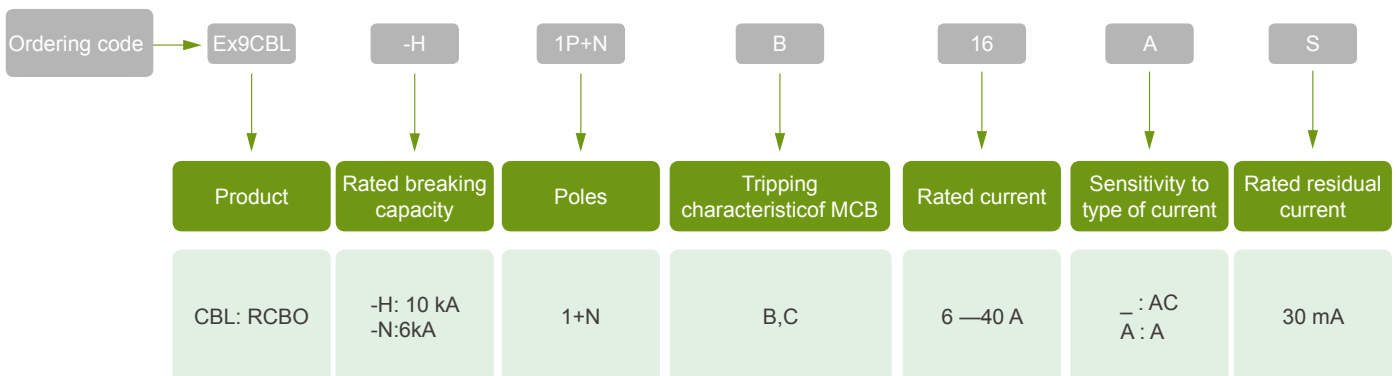



## Parameters

| Electrical parameters                              | Ex9CBL-H   | Ex9CBL-N |
|--|--|----------|
| Tested according to                                | IEC/EN 61009   |          |
| Rated op. voltage $U_e$                            | 230 V AC   |          |
| Min. voltage for RCD function                      | voltage independent  |          |
| Voltage range of the test button T                 | 110 — 254 V AC   |          |
| Rated frequency                                    | 50/60 Hz   |          |
| Conditional short circuit strength $I_{nc}$ ( kA ) | 10   | 6        |
| Rated current ( A )                                | 6 — 40   |          |
| Rated residual current ( mA )                      | 30   |          |
| Sensitivity to residual current                    | AC type - AC residual current<br>A type - residual AC and pulsating DC current |          |
| Time characteristic of RCD                         | undelayed type   |          |
| Tripping characteristics of MCB                    | B, C   |          |
| Rated impulse withstand voltage $U_{imp}$          | 4 kV   |          |
| Rated insulation voltage $U_i$                     | 500 V  |          |
| Mechanical service life                            | 2 000 operation cycles   |          |
| Electrical service life                            | 2 000 operation cycles   |          |
| Selectivity class                                  | 3  |          |
| Back-up fuse/breaker                               | max. 125 A gG  |          |
| Line voltage connection                            | arbitrary above or below   |          |

| Mechanical parameters           | Ex9CBL-H                                    | Ex9CBL-N                       |
|---------------------------------|---|--------------------------------|
| Device width                    | 36 mm                                       | 36 mm (2-pole), 72 mm (4-pole) |
| Device height                   | 85 mm including rail clip)                  |                                |
| Frame size                      | 45 mm                                       |                                |
| Mounting                        | easy fastening onto 35 mm device rail (DIN) |                                |
| Degree of protection            | IP20  |                                |
| Terminals                       | combined lift + open mouthed                |                                |
| Terminal capacity               | 1 — 35 mm <sup>2</sup>                      |                                |
| Fastening torque of terminals   | 1.5 — 2.5 Nm                                |                                |
| Busbar thickness                | 0.8 — 2 mm                                  |                                |
| Ambient temperature             | -5 — +40 °C                                 |                                |
| Altitude                        | ≤ 2000 m                                    |                                |
| Relative humidity               | ≤ 95 %                                      |                                |
| Resistance to humidity and heat | class 2                                     |                                |
| Pollution degree                | 2   |                                |
| Installation class              | III   |                                |

## Appearance



CB



CE

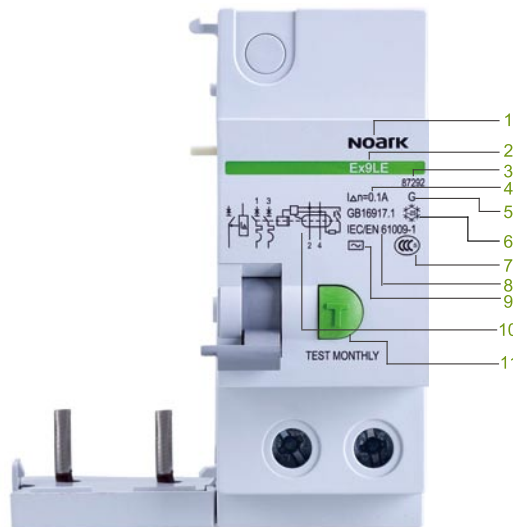

- 1 Brand
- 2 Type
- 3 Ordering code
- 4 rated residual operating current
- 5 With delay-time action **S** or over-voltage protection **G**
- 6 Temperature
- 7 Conformed standards
- 8 Certificates
- 9 Type of residual current
- 10 Electrical diagram
- 11 Test button

## Characteristics

When Ex9LE assembled with Ex9B, the following functions can be realized:

- Leakage protection for direct contact
- Leakage protection for indirect contact
- Insulation protection (for short circuit, electrical fire, etc)
- Complementary protection when other protection doesn't work
- "G" type over-voltage protection

### Conformed standards

IEC / EN61009-1

### Instantaneous residual trip

When residual current is bigger than the action value, the RCD block trips

### Type S

Delay-time protection: 0.13~0.5s

### Type G

Protection for over-voltage: AC280±5%V

### Manual operation

Two reset modes:

- MCB and RCD block reset at the same time.
- MCB resets first and then the RCD block.

## Usage Introduction

### Assembly with MCB

|       | MCB Ex9B | RCD block Ex9LE |
|-------|----------|-----------------|
| Poles | 1P       | 1PN             |
|       | 2P       | 2P              |
|       | 3P       | 3P/3PN          |
|       | 4P       | 4P              |

### Application guide

- Check the device monthly by pushing the test button to see whether the product trips.
- When selecting the products, please choose the MCB of corresponding rated current according to the ratio between control load (total power of load) and power voltage. Choose the rated residual action current according to the situation of residual current.
- For your safety, please do not test the RCD with residual current, overload or short circuit which caused by dangerous circuit.

## Selection Guide

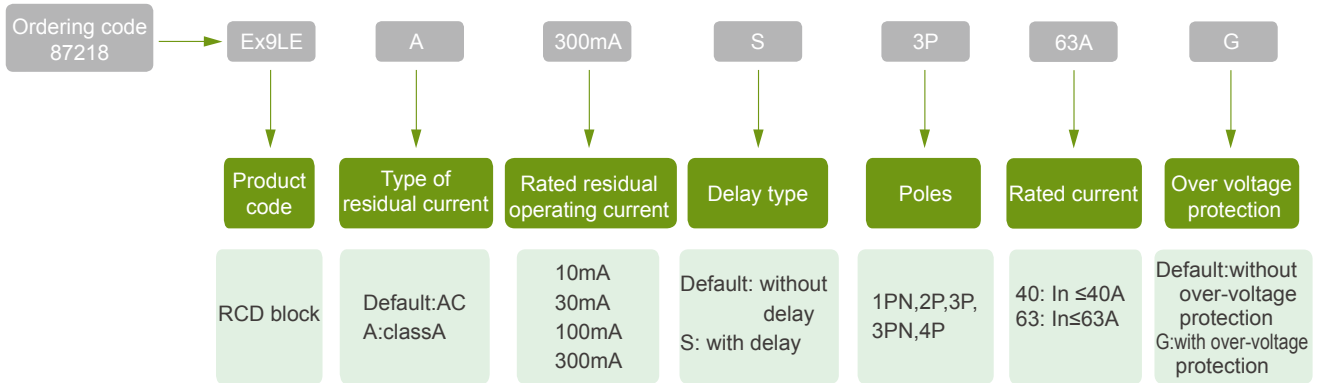

## Parameter

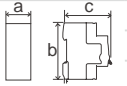
| RCD block Ex9LE   |  |       |      |      |      |      |      |
|---|--|-------|------|------|------|------|------|
| For protection of general power distribution (IEC/EN 60947-2) |  |       |      |      |      |      |      |
| Poles   | 1PN 2P 3P 3PN 4P   |       |      |      |      |      |      |
| Electrical performance  |  |       |      |      |      |      |      |
| Functions   | Protection against short current, overload, leakage, over-voltage, isolation and control |       |      |      |      |      |      |
| Type of residual current                                      | AC and A   |       |      |      |      |      |      |
| Rated frequency f Hz  | 50/60  |       |      |      |      |      |      |
| Rated working voltage Ue V                                    | 230/400  |       |      |      |      |      |      |
| Rated residual current $I_n$ mA                               | 10, 30, 100, 300   |       |      |      |      |      |      |
| Rated residual operating current                              | $I_n \leq 40, I_n \leq 63$   |       |      |      |      |      |      |
| Over-voltage protection of G type $I_n$ A                     | AC 280±5%V (Only for 1PN and 2P)   |       |      |      |      |      |      |
| Delaytime protection of S type                                | 0.13~0.5s (Only for 100mA and 300mA)   |       |      |      |      |      |      |
| Service life (C-O)  | Mechanica  | 16000 |      |      |      |      |      |
|   | Electrical   | 8000  |      |      |      |      |      |
| Connection and installation                                   |  |       |      |      |      |      |      |
| Protection degree   | IP20   |       |      |      |      |      |      |
| Mounting  | DIN35 rail   |       |      |      |      |      |      |
| Wire mm <sup>2</sup>  | $I_n \leq 32A, 1 \sim 25; I_n \geq 40A, 10 \sim 35$                                      |       |      |      |      |      |      |
| Working temperature   | -25~+40  |       |      |      |      |      |      |
| Resistance to humidity and heat                               | Class 2  |       |      |      |      |      |      |
| Altitude above sea m  | ≤2000  |       |      |      |      |      |      |
| Relative humidity   | +20 °C, ≤95%; +40 °C, ≤50%   |       |      |      |      |      |      |
| Pollution degree  | 2  |       |      |      |      |      |      |
| Installation environment                                      | Avoid obvious shock and vibration  |       |      |      |      |      |      |
| Installation class  | Class III  |       |      |      |      |      |      |
| Dimensions(mm)<br>(WxHxL)                                     |       | a     | 54   | 72   | 117  | 117  | 135  |
|   |  | b     | 89.5 | 89.5 | 89.5 | 89.5 | 89.5 |
|   |  | c     | 73   | 73   | 73   | 73   | 73   |



## Appearance



CB



CE

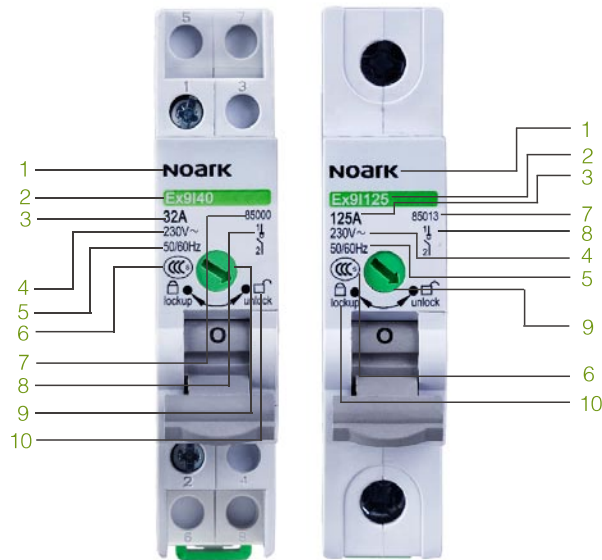

- 1 Brand
- 2 Type
- 3 Rated current
- 4 Rated voltage
- 5 Running frequency
- 6 Signal of certificates
- 7 Ordering code
- 8 Electrical diagram
- 9 Locker
- 10 Locking device for OFF position

## Characteristic

Ex9I40, Ex9I125 are based on Ex9B platform. Appearance dimension is the same as Ex9B products

Operation mechanism is safer and more reliable.

### Function :

- Break and connect circuit on load
- Isolation

Lock design of ON/OFF position

Optimized dimension design  
Ex9I40, width of 1P-4P are all 18mm

### Status indication

According to status of inner contact, Red/Green indication makes ON/OFF status visual.

### Conformed standard

IEC/EN 60947-3

## Selection Guide

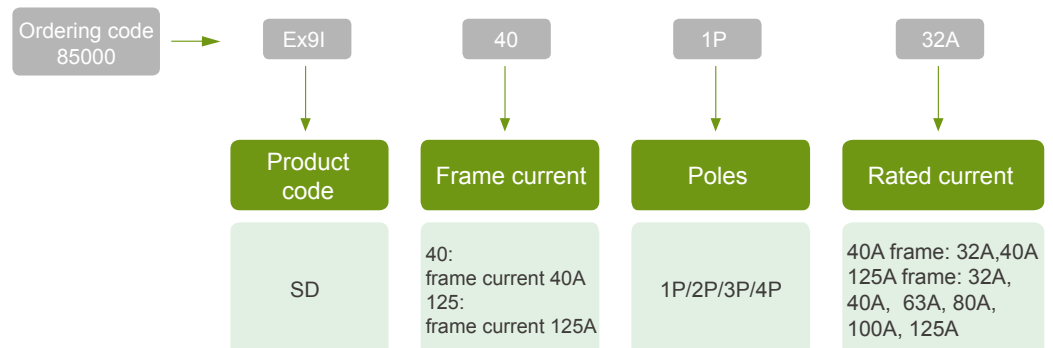



## Parameters

| Ex9I Switch Disconnecter   |                     |                                   |    |      |      |  |       |    |    |  |
|--|---------------------|-----------------------------------|----|------|------|--|-------|----|----|--|
| For protection of general distribution system ( IEC/EN 60947-3 ) |                     |                                   |    |      |      |  |       |    |    |  |
| Poles  |                     | 1P                                | 2P | 3P   | 4P   | 1P                                     | 2P    | 3P | 4P |  |
| Rated frame current  | A                   | 40                                |    |      |      | 125                                    |       |    |    |  |
| Electrical performance   |                     |                                   |    |      |      |  |       |    |    |  |
| Rated working voltage  | Ue                  | VAC                               |    |      |      | 230/400                                |       |    |    |  |
| Rated insulated voltage  | Ui                  | V                                 |    |      |      | 500                                    |       |    |    |  |
| Rated current  | In                  | A                                 |    |      |      | 32,40                                  |       |    |    |  |
| Rated short-time withstand current                               | le 1s               |                                   |    |      |      | 12                                     |       |    |    |  |
| Rated short-current making capacity                              | le (t=0.1s)         |                                   |    |      |      | 20                                     |       |    |    |  |
| Service life (C-O)   | Mechanical          | Actual value                      |    |      |      |  | 20000 |    |    |  |
|  |                     | Standard value                    |    |      |      |  | 8500  |    |    |  |
|  | Electrical          | Actual value                      |    |      |      |  | 4000  |    |    |  |
|  |                     | Standard value                    |    |      |      |  | 1500  |    |    |  |
| Connection and Installation                                      |                     |                                   |    |      |      |  |       |    |    |  |
| Protection degree  | All sides           |                                   |    |      |      | IP40                                   |       |    |    |  |
|  | Connection terminal |                                   |    |      |      | IP20                                   |       |    |    |  |
| Mounting   |                     | TH35-7.5/DIN35 rail               |    |      |      |  |       |    |    |  |
| Utilization category   |                     | AC-22A                            |    |      |      |  |       |    |    |  |
| Wire   | mm <sup>2</sup>     | Hard cable/Flexible calbe: 1~10   |    |      |      | Hard cable: 10~50;Flexible calbe:10~40 |       |    |    |  |
| Working temperature  |                     | -30~+70                           |    |      |      |  |       |    |    |  |
| Resistance to humidity and heat                                  |                     | Class 2                           |    |      |      |  |       |    |    |  |
| Altitude above sea   | m                   | ≤2000                             |    |      |      |  |       |    |    |  |
| Relative humidity  |                     | +20 , ≤95% ; +40 , ≤50%           |    |      |      |  |       |    |    |  |
| Pollution degree   |                     | 2                                 |    |      |      |  |       |    |    |  |
| Installation category  |                     | Class III                         |    |      |      |  |       |    |    |  |
| Installation environment   |                     | Avoid obvious shock and vibration |    |      |      |  |       |    |    |  |
| Appearance dimension (mm) ( WxHxL )                              |                     | a                                 | 18 |      | 18   | 36                                     | 54    | 72 |    |  |
|  |                     | b                                 | 89 |      | 89   |  |       |    |    |  |
|  |                     | c                                 | 80 |      | 80   |  |       |    |    |  |
| Weight   | kg                  | 0.06                              |    | 0.09 | 0.18 | 0.27                                   | 0.36  |    |    |  |

## Appearance



CB

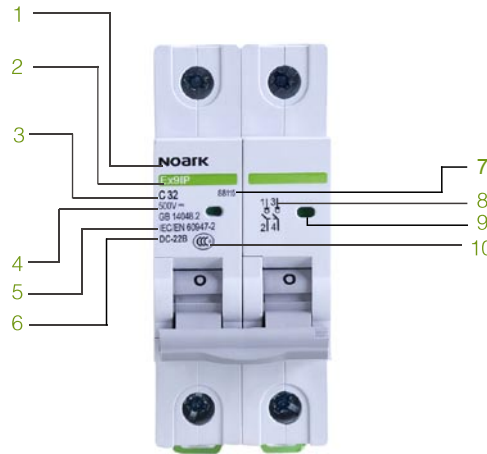

- 1 Brand
- 2 Type
- 3 Rated current
- 4 Rated voltage
- 5 Conformed standard
- 6 Utilization category
- 7 Ordering code
- 8 Electrical diagram
- 9 Status indicator
- 10 Signal of certificates

## Characteristic

Ex9IP are based on Ex9B platform. Appearance dimension is the same as Ex9B products

### Function :

- Break and connect circuit on load
- Isolation

### Status indication

According to status of inner contact, Red/Green indication makes ON/OFF status visual.

The working voltage which topped 1000VDC can provide a more reliable protection for PV system

### Conformed standard



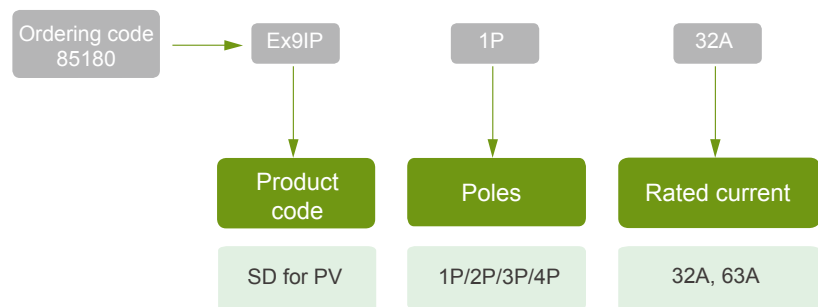

IEC/EN 60947-3

## Selection Guide



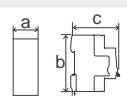

## Parameters

| SD Ex9IP for PV                        |   |                |   |   |   |   |
|--|---|----------------|---|---|---|---|
| For PV DC<br>( IEC/EN 60947-3 )        |   |                |  |  |  |  |
| Poles                                  |   |                | 1P  | 2P  | 3P  | 4P  |
| <b>Electrical performance</b>          |   |                |   |   |   |   |
| Rated working voltage                  | Ue  | VDC            | 250   | 500   | 750   | 1000  |
| Rated current                          | In  | A              | 32,63   |   |   |   |
| Rated insulated voltage                | Ui  | V              | 1000  |   |   |   |
| Rated short-time withstand current     | Ie  | 1s             | 12  |   |   |   |
| Rated short-current making capacity    | Ics   | 0.1s           | 20  |   |   |   |
| Service life (C-O)                     | Mechanical  | Actual value   | 10000   |   |   |   |
|  |   | Standard value | 1700  |   |   |   |
|  | Electrical  | Actual value   | 1000  |   |   |   |
|  |   | Standard value | 300   |   |   |   |
| <b>Connection and Installation</b>     |   |                |   |   |   |   |
| Protection degree                      | All sides   |                | IP40  |   |   |   |
|  | Connection terminal   |                | IP20  |   |   |   |
| Utilization category                   |   |                | DC-22B  |   |   |   |
| Wire                                   | mm <sup>2</sup>   |                | 1~35  |   |   |   |
| Working temperature                    |   |                | -30~+70   |   |   |   |
| Resistance to humidity and heat        |   |                | Class 2   |   |   |   |
| Altitude above sea                     |   |                | ≤2000   |   |   |   |
| Relative humidity                      |   |                | +20 , ≤95% ; +40 , ≤50%   |   |   |   |
| Pollution degree                       |   |                | 3   |   |   |   |
| Installation environment               |   |                | Avoid obvious shock and vibration   |   |   |   |
| Installation category                  |   |                | Class III   |   |   |   |
| Installation class                     |   |                | TH35-7.5/DIN35 rail   |   |   |   |
| Appearance dimension (mm)<br>( WxHxL ) |  | a              | 18  | 36  | 54  | 72  |
|  |   | b              | 89  |   |   |   |
|  |   | c              | 80  |   |   |   |
| Weight                                 | kg  |                | 0.12  | 0.24  | 0.36  | 0.48  |



## Appearance

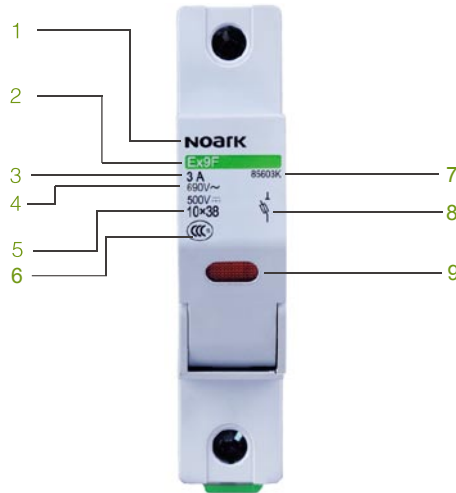

- 1 Brand
- 2 Type
- 3 Rated current
- 4 Rated voltage
- 5 Fuse size
- 6 Signal of certificates
- 7 Ordering code
- 8 Electrical diagram
- 9 Status indicator

## Characteristic

- The range of voltage: 690V AC, 500V DC
- Maximum of breaking capacity is 200KA to provide a reliable protection
- The innovation way of fuse replacing make the operation
- Fault indication will be on the light constantly when a fault occur, and to remind the customer replace the fuse timely
- The size of applicable fuse: 10×38mm

### Conformed standard

IEC/EN 60947-3

## Selection Guide

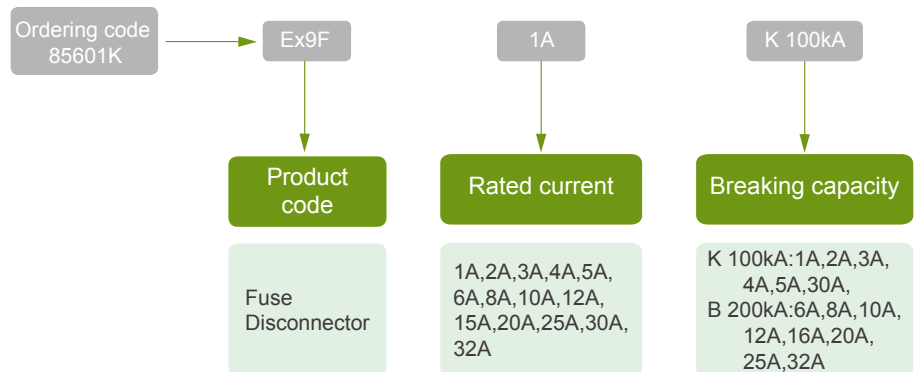

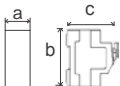

## Parameter

| Ex9F Fuse Disconnecter                 |   |   |                                   |                       |
|--|---|---|-----------------------------------|-----------------------|
| For AC/DC<br>(IEC/EN 60269)            |   |  |                                   |                       |
| Poles                                  |   | 1P  |                                   |                       |
| Electrical performance                 |   |   |                                   |                       |
| Rated working voltage                  | Ue  | V AC/V DC   | 690V AC/500V DC                   | 600V AC/400V DC       |
| Rated current                          | In  | A   | 1,3,4,5,30                        | 6,8,10,12,16,20,25,32 |
| Breaking capacity                      | kA  |   | 100                               | 200                   |
| Max power dissipation                  | w   |   | 7.5                               |                       |
| Connection and Installation            |   |   |                                   |                       |
| Protection degree                      |   |   | IP20                              |                       |
| Wire                                   | mm <sup>2</sup>   |   | 2.5~10                            |                       |
| Working temperature                    |   |   | -30~+70                           |                       |
| Resistance to humidity and heat        |   |   | Class 2                           |                       |
| Altitude above sea                     |   |   | ≤2000                             |                       |
| Relative humidity                      |   |   | +20 , ≤95% ; +40 , ≤50%           |                       |
| Pollution degree                       |   |   | 3                                 |                       |
| Installation environment               |   |   | Avoid obvious shock and vibration |                       |
| Installation class                     |   |   | Class III                         |                       |
| Installation category                  |   |   | TH35-7.5/DIN35 rail               |                       |
| Appearance dimension (mm)<br>( WxHxL ) |  | a   | 18                                |                       |
|  |   | b   | 89                                |                       |
|  |   | c   | 80                                |                       |
| Fuse size                              | mm  |   | 10x38                             |                       |
| Weight                                 | kg  |   | 0.07                              |                       |

## Appearance



CB

CE

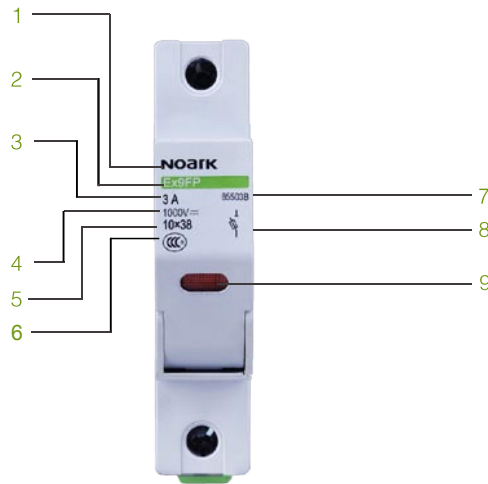

- 1 Brand
- 2 Type
- 3 Rated current
- 4 Rated voltage
- 5 Fuse size
- 6 Signal of certificates
- 7 Ordering code
- 8 Electrical diagram
- 9 Status indicator

## Characteristic

- The range of voltage: 1000V DC
- Maximum of breaking capacity is 33KA to provide a reliable protection
- The innovation way of fuse replacing make the operation safer
- Fault indication will be on the light constantly when a fault occur, and to remind the customer replace the fuse timely
- The size of applicable fuse: 10×38mm

### Conformed standard



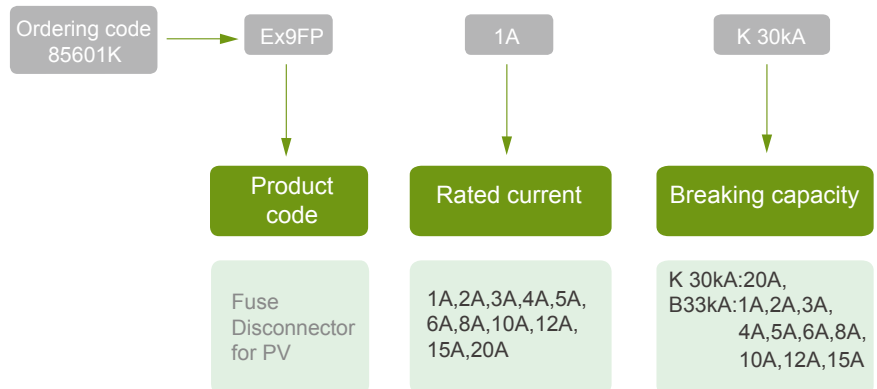

IEC/EN 60269

## Selection Guide





## Parameter

| Ex9FP Fuse Disconnecter for PV            |   |   |                        |
|---|---|---|------------------------|
| For PV DC<br>( IEC/EN 60269)              |   |  |                        |
| Poles                                     |   | 1P/2P   |                        |
| Electrical performance                    |   |   |                        |
| Rated working voltage                     | Ue  | VDC   | 1000                   |
| Rated current                             | In  | A   | 1,2,3,4,5,6,8,10,12,15 |
| Breaking capacity                         | kA  |   | 33                     |
| Max power dissipation                     | w   |   | 3                      |
| Connection and Installation               |   |   |                        |
| Protection degree                         |   | IP20  |                        |
| Wire                                      | mm <sup>2</sup>   | 2.5~10  |                        |
| Working temperature                       |   | -30~+70   |                        |
| Resistance to humidity and heat           |   | Class 2   |                        |
| Altitude above sea                        |   | ≤2000   |                        |
| Relative humidity                         |   | +20 , ≤95% ; +40 , ≤50%   |                        |
| Pollution degree                          |   | 3   |                        |
| Installation environment                  |   | Avoid obvious shock and vibration   |                        |
| Installation class                        |   | Class III   |                        |
| Installation category                     |   | TH35-7.5/DIN35 rail   |                        |
| Appearance<br>dimension (mm)<br>( WxHxL ) |  | a   | 18                     |
|   |  | b   | 89                     |
|   |  | c   | 80                     |
| Fuse size                                 | mm  | 10x38   |                        |
| Weight                                    | kg  | 0.07  |                        |



## Parameter



### Surge Protective Device

Surge Protective Device is a kind of protecting equipment which can protect protect from surge which influenced by Indirect and direct lightning thunder and other transient overvoltage.

### Test classification of SPD

- Ex9U1 level I  
The test is done with  $I_n 1.2/50\mu s$  and  $I_{imp} 10/350\mu s$ . The SPD level I can protect the power supply of low voltage distribution system from the direct lightning thunder. It is used in the high risk areas of lightning and installed in main distribution panels.
- Ex9U2 level II  
The test is done with  $I_n 1.2/50\mu s$  and  $I_{max} 8/20\mu s$ . The SPD level II can support the impaction in a short time and protect the circuit comprehensively.
- Ex9U3 level III  
The test do with composite wave (  $U_{oc} 1.2/50\mu s$  and  $I_{sc} 8/20\mu s$  ). The SPD level III is installed in the equipment as close as possible to protect extremely sensitive equipment.

### Parameter definitions of SPD

- Nominal discharge current  $I_n$ :  
The peak current flow past the protector with  $8/20\mu s$  current wave. It is used in test level II, and in the pretreatment of test level I and II moreover.
- Maximum discharge current  $I_{max}$ :  
The max discharging peak current flow past the protector with  $8/20\mu s$  standard ray wave. It is difined by the program of load level II.
- Max impulse current  $I_{imp}$  :  
The parameter indicated the SPD with test level I. It means the protector can receive a max impulse current  $10/350\mu s$ ; it is determined by  $I_{peak}$  and  $Q$ .
- Max continuous operational voltage  $U_c$ :  
abidingly applied in the specified end of protector which do not cause the performance change of the protector and do not make the protection components act inaccurate.  $U_c$  equals to rated voltage.
- Open voltage  $U_{oc}$ :  
The parameter indicated the SPD with test level III. It means this kind of SPD can receive the impluse voltage which end voltage is  $1.2/50\mu s$  wave when the composite wave generator virtual intrinsic impedance is  $2\Omega$  outlet open circuit, theamplitude must less than  $20kV$  ( We must test level II if overstep ).
- Short circuit current  $I_{sc}$ :  
The parameter indicated the SPD which accord with test level III. It means this kind of SPD can receive the current  $I_{sc}$  is  $8/20\mu s$  wave when the composite wave generator virtual intrinsic impedance is  $2\Omega$  outlet short circuit, the amplitude is  $0.5U_{oc}$ .
- Voltage protection level  $U_p$ :  
the ability of SPD to control the surge, meaning the max voltage of protector in the follow test.
  1. Test by the nominal discharge current.
  2. Test by the composite wave after the surge voltage being limited.

## Selection Guide

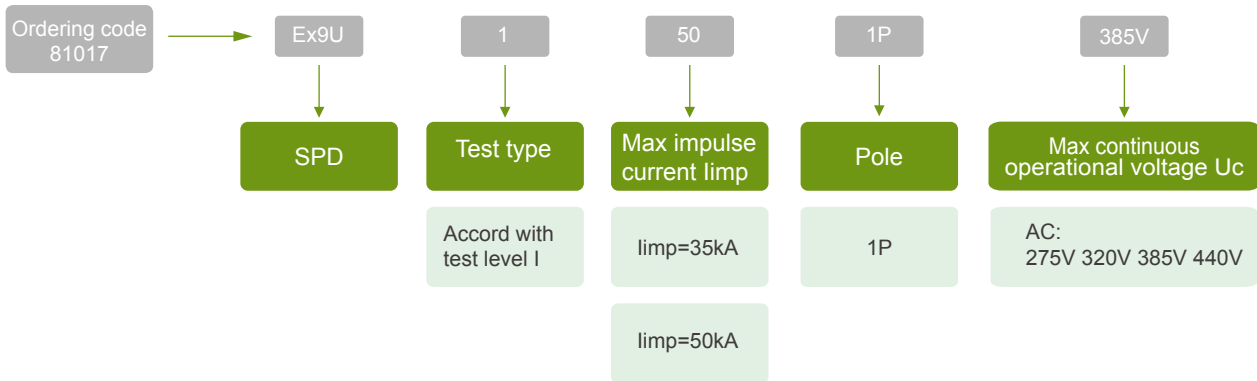

## Parameter

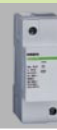
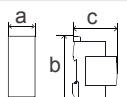
| SPD Ex9U1   |   |                 | Ex9U1 35   |      | Ex9U1 50   |  |
|---|---|-----------------|--|------|--|--|
| For protection of general power distribution ( IEC 61643-1/EN 61643-11) |   |                 |  |      |  |  |
| Poles   |   |                 | 1P   |      |  |  |
| <b>Electrical performance</b>   |   |                 |  |      |  |  |
| Test type   |   |                 | I  |      |  |  |
| Frequency   | f   | Hz              | 50/60  |      |  |  |
| Nominal discharge current   | I <sub>n</sub>  | kA              | 35   | 50   |  |  |
| Max impulse current   | I <sub>imp</sub> (10/350us)   | kA              | 35   | 50   |  |  |
| Voltage protection level  | U <sub>p</sub>  | kV              | 4.0  |      |  |  |
| Max continuous operational voltage                                      | U <sub>c</sub>  | V               | 3.5  |      |  |  |
| <b>Control and indication</b>   |   |                 |  |      |  |  |
| Instruction   |   |                 | —  |      |  |  |
| Insertable module   |   |                 | —  |      |  |  |
| Remote contact  |   |                 | —  |      |  |  |
| <b>Connection and Installation</b>                                      |   |                 |  |      |  |  |
| Wire  | Hard cable  | mm <sup>2</sup> | 4~35   |      |  |  |
|   | Flexible calbe  | mm <sup>2</sup> | 4~25   |      |  |  |
| Stripping length  |   | mm              | 10   |      |  |  |
| Protection degree   | All sides   |                 | IP40   |      |  |  |
|   | Connection terminal   |                 | IP20   |      |  |  |
| Installation environment  |   |                 | Avoid obvious shock and vibration  |      |  |  |
| Altitude above sea  |   |                 | ≤2000  |      |  |  |
| Working temperature   |   |                 | -30~+70  |      |  |  |
| Relative humidity   |   |                 | 30%~90%  |      |  |  |
| Installation category   |   |                 | TH35-7.5/DIN35 rail  |      |  |  |
| Appearance dimension (mm) ( WxHxL )                                     |  |                 | a  | 18   |  |  |
|   |   |                 | b  | 91   |  |  |
|   |   |                 | c  | 67.6 |  |  |
| Weight  |   |                 | kg 0.17  |      |  |  |

■ Standard    □ Optional    — None

## Selection Guide

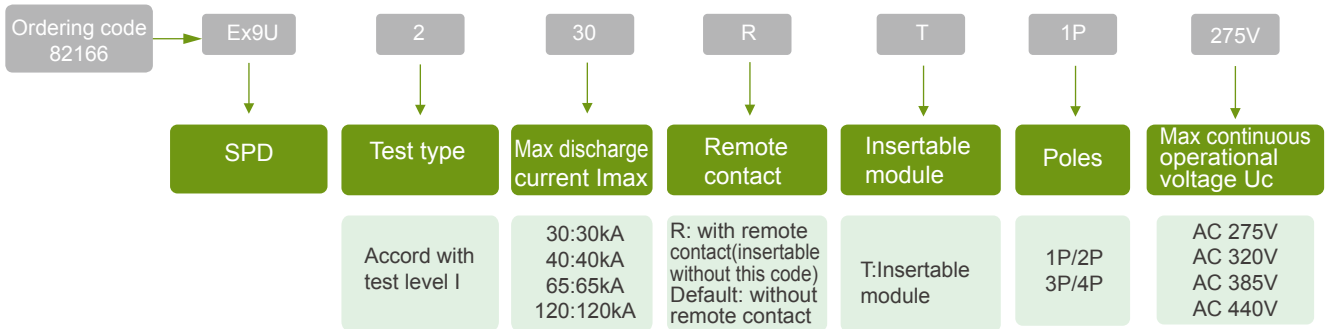



## Parameter

| SPD Ex9U2   |  |  | Ex9U2 30   | Ex9U2 40 | Ex9U2 65        | Ex9U2 120       |
|---|--|--|--|----------|-----------------|-----------------|
| For protection of general power distribution ( IEC 61643-1/EN 61643-11) |  |  |  |          |                 |                 |
| Poles   |  |  | 1P/2P/3P/4P  |          |                 |                 |
| Electrical performance  |  |  |  |          |                 |                 |
| Test type   |  |  | II   |          |                 |                 |
| Frequency f Hz  |  |  | 50/60  |          |                 |                 |
| Norminal discharge current In kA  |  |  | 15   | 20       | 30              | 65              |
| Max impulse current Iimp kA   |  |  | 30   | 40       | 65              | 120             |
| Voltage protection level Up kV  |  |  | 1.3-1.5-1.8-2.2  |          | 1.5-1.8-2.0-2.5 | 2.0-2.5-2.8-3.0 |
| Max continuous operational voltage Uc V                                 |  |  | 3.5  |          |                 |                 |
| Control and indication  |  |  |  |          |                 |                 |
| Instruction   |  |  | ■  |          |                 |                 |
| Insertable module   |  |  | ■  |          |                 |                 |
| Remote contact  |  |  | □  |          |                 |                 |
| Remote contact  |  |  | Max working voltage V<br>250V AC / 30V DC  |          |                 |                 |
| Remote contact  |  |  | Max working current ( Resistive/ Inductive )<br>1A (250V AC )                    |          |                 |                 |
| Remote contact  |  |  | Max working current ( Resistive/ Inductive )<br>1A (30V DC )                     |          |                 |                 |
| Connection and Installation   |  |  |  |          |                 |                 |
| Wire  |  |  | Hard calbe mm <sup>2</sup><br>input terminal : 0.2~10; outlet terminal: 2.5~25   |          |                 |                 |
| Stripping length  |  |  | Flexible calbe mm <sup>2</sup><br>input terminal :0.2~6; outlet terminal: 2.5~16 |          |                 |                 |
| Protection degree   |  |  | All sides<br>10  |          |                 |                 |
| Installation environment  |  |  | Connection terminal<br>IP40  |          |                 |                 |
| Altitude above sea  |  |  | Avoid obvious shock and vibration<br>≤2000                                       |          |                 |                 |
| Working temperature   |  |  | -30~+70  |          |                 |                 |
| Relative humidity   |  |  | 30%~90%  |          |                 |                 |
| Installation category   |  |  | TH35-7.5/DIN35 rail  |          |                 |                 |
| Appearance dimension (mm) ( WxHxL )                                     |  |  | <br>a 18<br>b 102<br>c 67.6  |          |                 |                 |
| Weight  |  |  | kg 0.12  |          |                 |                 |

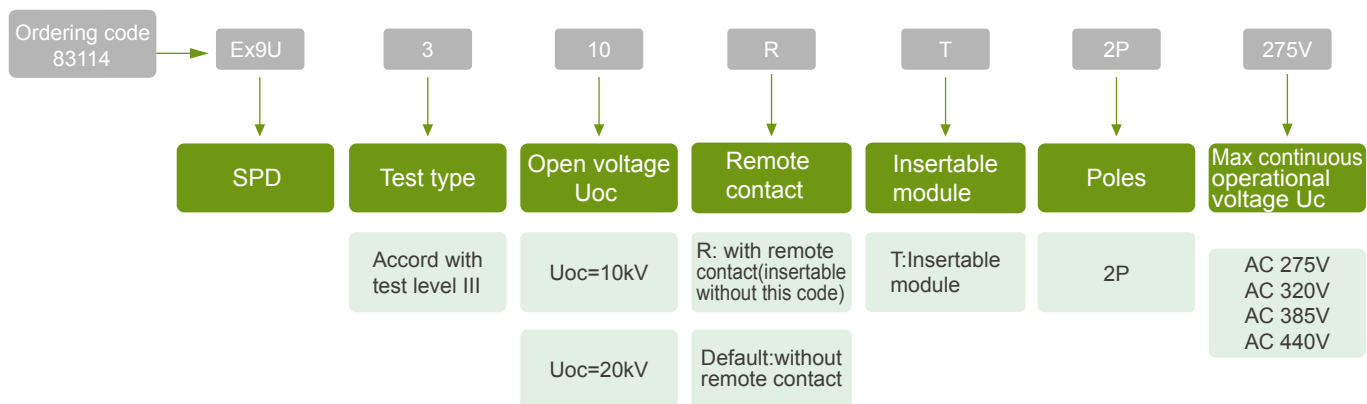
## Selection Guide

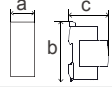

## Parameter

| SPD Ex9U3   |   | Ex9U3 10   |  | Ex9U3 20   |  |
|---|---|--|--|--|--|
| For protection of general power distribution ( IEC 61643-1/EN 61643-11) |   |  |  |  |  |
| Poles   |   | 2P   |  |  |  |
| Electrical performance  |   |  |  |  |  |
| Test type   |   | III  |  |  |  |
| Frequency   | f Hz  | 50   |  | 60   |  |
| Open voltage  | Uoc(1.2/50us) kV  | 10   |  | 20   |  |
| Short circuit current   | Isc(8/20us) kA  | 5  |  | 10   |  |
| Voltage protection level  | Up kV   | 1-1.2-1.5  |  | 1.2-1.5-1.6  |  |
| Control and indication  |   |  |  |  |  |
| Instruction   |   | ■  |  |  |  |
| Insertable module   |   | ■  |  |  |  |
| Remote contact  |   | □  |  |  |  |
| Remote contact  |   | Max working voltage (V) 250V AC / 30V DC   |  |  |  |
| Remote contact  |   | Max working current( Resistive/ Inductive ) 1A (250V AC )                          |  |  |  |
| Remote contact  |   | Max working current( Resistive/ Inductive ) 1A (30V DC )                           |  |  |  |
| Connection and Installation   |   |  |  |  |  |
| Wire  | Hard calbe  | mm <sup>2</sup>  | input terminal : 0.2~10; outlet terminal: 2.5~25 |  |  |
|   | Flexible calbe  | mm <sup>2</sup>  | input terminal : 0.2~6; outlet terminal: 2.5~16  |  |  |
| Stripping length  | mm  |  | 10   |  |  |
| Protection degree   | All sides   |  | IP40   |  |  |
|   | Connection terminal   |  | IP20   |  |  |
| Installation environment  |   | Avoid obvious shock and vibration  |  |  |  |
| Altitude above sea  |   | ≤2000  |  |  |  |
| Working temperature   |   | -30~+70  |  |  |  |
| Relative humidity   |   | 30%~90%  |  |  |  |
| Installation category   |   | TH35-7.5/DIN35 rail  |  |  |  |
| Appearance dimension (mm) ( WxHxL )                                     |  |  | a 18   |  |  |
|   |   |  | b 102  |  |  |
|   |   |  | c 67.6   |  |  |
| Weight  | kg  |  | 0.12   |  |  |

■ Standard □ Optional — None

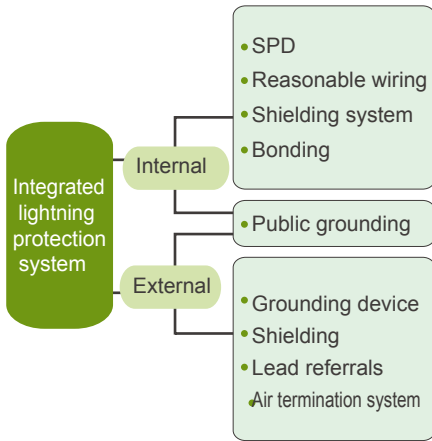

Figure 1

### The integrated lightning protection measures and the functioning of the SPD

Nowadays, designing a system of lightning protection is involved in choosing different lightning protection equipment like the SPD. Lightning protection system is complex and huge, and the SPD plays a crucial role in it. Figure 1 shows the SPD position in the lightning protection system.

The overvoltage of the power circuit can be divided into three protection levels:

- Protection level 1 is installed in the entrance of a house or the main distribution box. Because of the residual voltage is still too high to bear to the follow-up equipment, the other protector must be installed according to the definition of protection scope.
- If the follow-up equipment as floor distribution panel cabinets or junction box of large electronic equipment, the overvoltage lightning protection device should be installed as protection level 2.
- The overvoltage protector should be installed in front of the equipment as protection level 3.
- Multi-level protection combined organically to achieve the optimization of overall protection performance.

### The choice of $U_c$

With use security of SPD, the choice of  $U_c$  must satisfy the following rules :  $U_c$  should be higher than  $U_{cs}(k \times U_0)$  which may produce in system ( Minimum table below: the relationship between  $U_c$  and system nominal voltage ). Considering the complexity of the system fault,  $U_c$  at least be  $1.5U_0$  recommended.



$U_c$  according to IEC 60364-5-534

| SPD is installed between PE and PEN in TN system or between phase and neutral in TT system | SPD is installed between phase and ground or between neutral and ground in TT system<br>$U_c \text{ min}$ | SPD is installed between phase and ground or between neutral and ground in IT system<br>$U_c \text{ min}$ | SPD is installed between phases in TT , TN or IT system<br>$U_c \text{ min}$ |
|--|---|---|--|
| Voltage regulation is equal to 10%   | The value of $1.5 \times U_0$ has been used   | The value of $\sqrt{3} \times U_0$ has been used  | Voltage regulation is equal to 10%   |
| V  | V   | V   | V  |
| 132  | 180   |   | 229  |
| 140  | 191   | 220   | 242  |
|  |   | 240   | 264  |
|  |   | 347   | 382  |
| 253  | 345   | 400   | 440  |
| 286  | 390   | 415   | 484  |
| 305  | 416   | 480   | 528  |

a- Maybe require a higher value in some cases(For example,the neutral line break in the TT system)

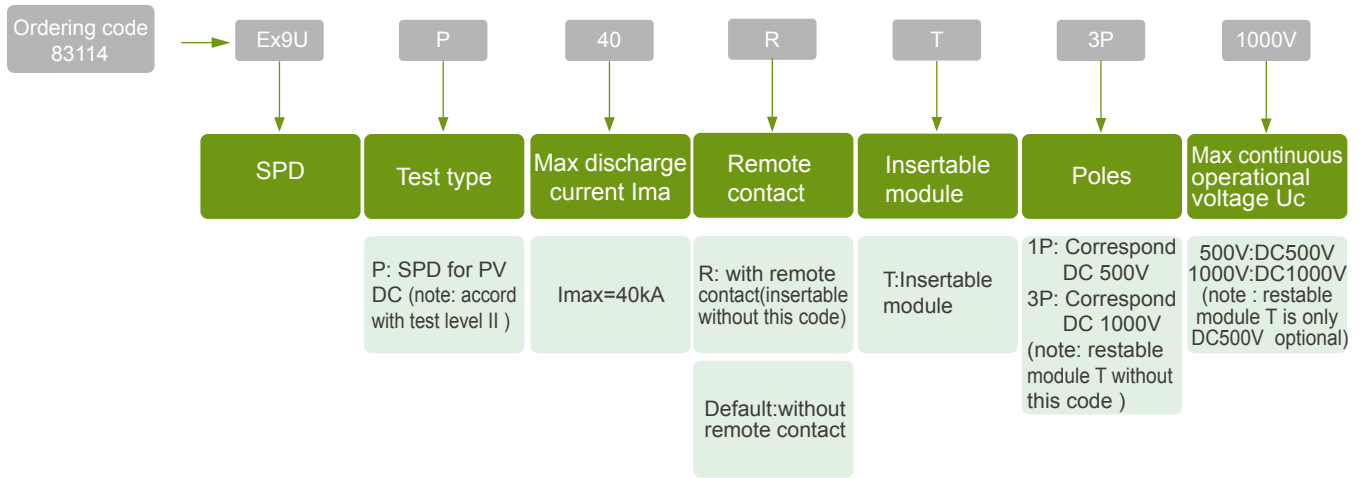
## Selection Guide

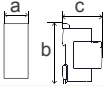

| SPD Ex9UP   |   |                 | Ex9UP  |  |
|---|---|-----------------|--|--|
| For PV DC<br>( IEC 61643-1/ EN 61643-11)                    |   |                 |  |  |
| Poles   |   |                 | 1P   | 3P   |
| Electrical performance                                      |   |                 |  |  |
| Test type   |   |                 | II   |  |
| Open voltage  | $U_{oc}$ max  | V DC            | 500  | 1000   |
| Max continuous operational voltage                          |   | $U_c$           | 500  | 1000   |
| Nominal discharge current $I_n(8/20)\mu s$                  |   | kA              | 20   |  |
| Maximum discharge current $I_{max}(8/20)\mu s$              |   | kA              | 40   |  |
| Voltage protection level $U_p$                              |   | kV              | 2.0  | 3.8  |
| Control and indication                                      |   |                 |  |  |
| Instruction   |   |                 | ■  |  |
| Insertable module   |   |                 | ■  |  |
| Remote contact  |   |                 | □  |  |
| Remote contact Max working voltage (V)                      |   |                 | 250V AC / 30V DC   |  |
| Remote contact Max working current( Resistive/ Inductive )  |   |                 | 1A (250V AC )  |  |
| Remote contact Max working current ( Resistive/ Inductive ) |   |                 | 1A (30V DC )   |  |
| Connection and Installation                                 |   |                 |  |  |
| Wire  | Hard calbe  | mm <sup>2</sup> | 4~25   |  |
|   | Flexible calbe  | mm <sup>2</sup> | 4~16   |  |
| Stripping length  | mm  |                 | 10   |  |
| Terminal screws   |   |                 | M5   |  |
| Torque (Nm)   | Main circuit  |                 | 3.5  |  |
|   | Remote contact  |                 | 0.25   |  |
| Protection degree   | All sides   |                 | IP40   |  |
|   | Connection terminal   |                 | IP20   |  |
| Installation environment                                    |   |                 | Avoid obvious shock and vibration  |  |
| Altitude above sea  |   |                 | ≤2000  |  |
| Working temperature   |   |                 | -30~+70  |  |
| Relative humidity   |   |                 | 30%~90%  |  |
| Installation category                                       |   |                 | TH35-7.5/DIN35 rail  |  |
| Appearance dimension (mm)<br>( WxHxL )                      |  | a               | 18   | 54   |
|   |   | b               | 102  | 99   |
|   |   | c               | 67.6   | 67.6   |
| Weight  | kg  |                 | 0.12   | 0.36   |
| ■ Standard □ Optional — None                                |   |                 |  |  |



## Characteristic



- Busbars for connection of installation devices
- 1 and 3 - phase versions
- 10 mm<sup>2</sup> for 63 A and 16 mm<sup>2</sup> for 80 A
- Lengths 1 meter (54 modules) or 12 modules
- Fork version of connection points
- Step 1 module (18 mm)

Rated operational voltage 230/400 V AC

Rated frequency 50 Hz

Busbars for simple and reliable interconnection of installation devices. Shortened versions for 12 modules are equipped with end caps. There are available separately packed end caps for busbars with length of 1 m.



## Selection Guide

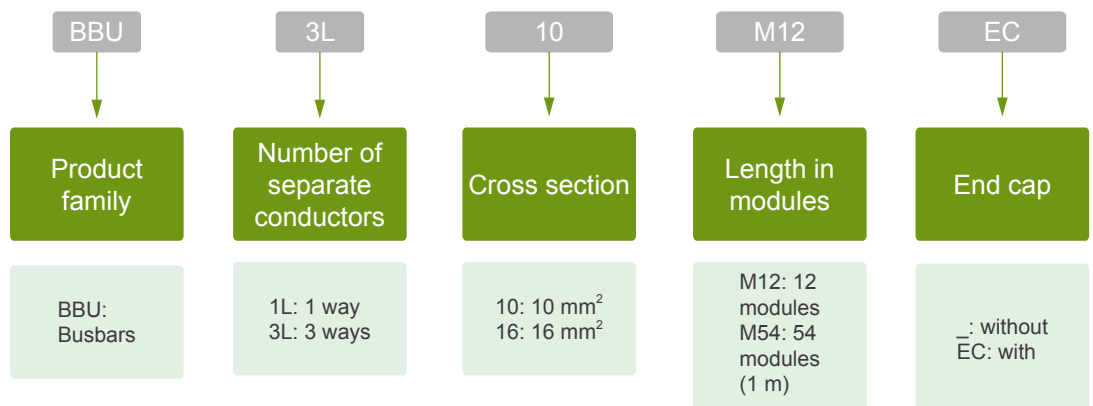



## Technical Data Busbars BBU

### General parameters

1 and 3-phase busbars

Length 1 meter (with 54 connection points, can be shortened) or 12 modules (with 12 connection points)

Delivered without end caps (1 m / 54 modules) or with end caps (12 modules)

### Electrical parameters

Tested according to EN 60439-1

Rated op. voltage 230 / 400 V AC

Rated current 63 A (10 mm<sup>2</sup>), 80 A (16 mm<sup>2</sup>)

Rated frequency 50 Hz

### Mechanical parameters

Busbar cross section 10 or 16 mm<sup>2</sup>

Connection point step 1 module (18 mm)





## Features

### Ex9C Series AC Contactor

- Products with exquisite appearance ,compact structure ,well arrangement and easy installation
- Modular design for easy extension of product features
- With more normally open and closed contacts
- Two mounting ways by standard card and mounting screws
- Mechanical service life of 10 million times, AC-3 electrical service life of 1.2 million times
- Meet the safety standards of straight-acting double-contact design
- Comes with dust-proof device, able to adapt to harsh environment
- Application of environmental temperature range (-20 ~ 60 )
- Have proprietary intellectual property rights with 5 inventive patents, 7 new practical patents and 5 appearance patents
- Special small contactor (6A~12A),suitable for small capacity motor load

| Specification | Length(mm) | Width(mm) | Thickness(mm) |
|---------------|------------|-----------|---------------|
| Ex9CS06       | 59         | 45        | 58            |
| Ex9CS09       |            |           |               |
| Ex9CS012      |            |           |               |

- Machine with semi-automatic production line model
- Process testing,product commissioning and product testing etc.are controlled by computer and do the full check
- Key processes are using advanced manufacturing engineering such as laser welding and auto wiring etc.

## Operating Conditions

### Temperature

- -20 - +60

### Altitude

- altitude 2,000 m.

### Humidity

The following conditions must be met during normal operation:

- If the ambient air temperature is +40oC, the atmospheric relative humidity can not exceed 50%. If the temperature is lower, use it under the conditions for a higherdegree of humidity
- The monthly mean relative humidity needs to be below 90% in the dampest month
- The effects of condensation on the product surface impacts its performance and needs to be taken into consideration

### Pollution Level



- Level

### Installation

- Contactors with rated current <100A could be either installed by screw of Din-rail.(DIN Rail(35mm)/DIN Rail(75mm))
- Contactors with rated current between 115A~500A should be installed with screws.
- Inclination between mounting and vertical plane shoule be less than  $\pm 30^{\circ}$



## Parameters



| Ex9C Series AC Contactor                                    |  | Ex9CS06   | Ex9CS09 | Ex9CS12  | Ex9C09  | Ex9C12 | Ex9C18 |
|---|--|---|---------|--|---|--------|--------|
| IEC 60947-4-1   |  |  |         |  |  |        |        |
| Poles   |  | 3P/4P   |         |  | 3P  |        |        |
| Electrical performance                                      |  |   |         |  |   |        |        |
| Operation frequency   |  | 50/60   |         |  | 50/60   |        |        |
| Rated conventional heating current $I_{th}(A)\theta\leq 60$ |  | 20  |         |  | 25  |        | 32     |
| Rated operational current(A)                                |  | 20  |         |  | 25  |        | 32     |
| AC-1  |  | 20  |         |  | 25  |        | 32     |
| 380V/400V AC-2/AC-3/AC-4                                    |  | 6   | 9       | 12   | 9   | 12     | 18     |
| 660V/690V AC-3  |  | 3.8   | 4.9     |  | 6.7   | 9      | 10.6   |
| AC-4/AC-2   |  | 3.8   | 4.9     |  | 4.9   |        | 6.7    |
| Rated insulation voltage $U_i(V)$                           |  | 690   |         |  | 690   |        |        |
| 380V/400V AC-3/AC-4   |  | 2.2   | 4       | 5.5  | 4   | 5.5    | 7.5    |
| Max. power of 3-phase motor(kW)                             |  | 3   | 4       |  | 5.5   | 7.5    | 9      |
| 660V/690V AC-4  |  | 3   | 4       |  | 4   |        | 5.5    |
| Electrical durability ( $\times 10^3$ cycles)               |  | 120   |         |  | 120   |        |        |
| 380V/400V AC-3  |  | 120   |         |  | 120   |        |        |
| AC-4  |  | 50  | 40      |  | 50  | 40     |        |
| Mechanical cycles ( $\times 10^3$ cycles)                   |  | 1000  |         |  | 1000  |        |        |
| Holding power   |  | 9C Eries(VA)  |         | 7.5  | 9.5   |        |        |
| Control voltage $U_c(V)$                                    |  | 9C Eries  |         | AC:24,36,42,48,110,127,220,230,240,380,400,415 |   |        |        |
| Connection and installation                                 |  |   |         |  |   |        |        |
| Auxiliary contacts  |  | 1NO/1NC   |         |  | 1NO+1NC/2NO+2NC   |        |        |
| Mounting type   |  | DIN Rail(35mm)  |         |  | DIN Rail(35mm)  |        |        |
| Dimension(L×W×H)  |  | 59×45×58  |         |  | 89×45×94  |        |        |
| Weight (Kg)   |  | 0.18  |         |  | 0.35  |        |        |
| Safe area(mm)   |  | 0   |         |  | 3   |        |        |
| Matched thermal overload relay                              |  |   |         |  |   |        |        |
| Models  |  | Ex9R12  |         |  | Ex9R38  |        |        |
| Matched mechanical interlocking device                      |  |   |         |  |   |        |        |
| Models  |  | MIT41   |         |  | MIT42   |        |        |
| Add-on auxiliary contact blocks                             |  |   |         |  |   |        |        |
| Top mounting  |  | 4NC   | AX4104  |  | AX4204  |        |        |
|   |  | 1NO+3NC   | AX4113  |  | AX4213  |        |        |
|   |  | 2NO+2NC   | AX4122  |  | AX4222  |        |        |
|   |  | 3NO+1NC   | AX4131  |  | AX4231  |        |        |
|   |  | 4NO   | AX4140  |  | AX4240  |        |        |
|   |  | 2NC   | —       |  | AX4202  |        |        |
|   |  | 1NO+1NC   | —       |  | AX4211  |        |        |
|   |  | 2NO   | —       |  | AX4220  |        |        |
| Side mounting   |  | 1NO+1NC   | —       |  | AX4311  |        |        |

| Ex9C25  | Ex9C32 | Ex9C38 | Ex9C40  | Ex9C50 | Ex9C65 | Ex9C80  | Ex9C100 |
|---|--------|--------|---|--------|--------|---|---------|
|  |        |        |  |        |        |  |         |
| 3P  |        |        | 3P  |        |        | 3P  |         |
| 50/60   |        |        | 50/60   |        |        | 50/60   |         |
| 40  | 50     |        | 60  | 80     |        | 125   |         |
| 40  | 50     |        | 60  | 80     |        | 125   |         |
| 25  | 32     | 38     | 40  | 50     | 65     | 80  | 100     |
| 17.3  | 21.9   |        | 34  | 39     | 42     |   | 49      |
| 14  | 17.3   |        | 34  | 39     | 42     |   | 49      |
| 690   |        |        | 1000  |        |        | 1000  |         |
| 11  | 15     | 18.5   | 18.5  | 22     | 30     | 37  | 45      |
| 15  | 18.5   |        | 30  | 33     | 37     |   | 45      |
| 11  | 15     |        | 30  | 33     | 37     |   | 45      |
| 120   |        |        | 120   |        |        | 120   |         |
| 50  | 40     |        | 35  | 30     |        |   | 25      |
| 1000  |        |        | 1000  |        |        | 1000  |         |
| 10.5  |        |        | 25.0  |        |        | 30.0  |         |
| AC:24,36,42,48,110,127,220,230,240,380,400,415                                    |        |        |   |        |        |   |         |
| 1NO+1NC/2NO+2NC   |        |        | 1NO+1NC   |        |        | 1NO+1NC   |         |
| DIN Rail(35mm)  |        |        | DIN Rail(35mm)/DIN Rail(75mm)   |        |        | DIN Rail(35mm)/DIN Rail(75mm)   |         |
| 100×45×108  |        |        | 122×76×123  |        |        | 130×87×130  |         |
| 0.4   |        |        | 1.23  |        |        | 1.5   |         |
| 5   |        |        | 12  |        |        | 12  |         |
| Ex9R38  |        |        | Ex9R100   |        |        | Ex9R100   |         |
| MIT42   |        |        | MIT43   |        |        | MIT43   |         |
| AX4204  |        |        |   |        |        |   |         |
| AX4213  |        |        |   |        |        |   |         |
| AX4222  |        |        |   |        |        |   |         |
| AX4231  |        |        |   |        |        |   |         |
| AX4240  |        |        |   |        |        |   |         |
| AX4202  |        |        |   |        |        |   |         |
| AX4211  |        |        |   |        |        |   |         |
| AX4220  |        |        |   |        |        |   |         |
| AX4311  |        |        |   |        |        |   |         |





## Parameters

| Ex9C Series AC Contactor  |           |      | Ex9C115  | Ex9C150 | Ex9C185 |
|---|-----------|------|--|---------|---------|
| IEC 60947-4-1   |           |      |  |         |         |
| Poles   |           |      | 3P   |         |         |
| Electrical performance  |           |      |  |         |         |
| Operation frequency(Hz)   |           |      | 50/60  |         |         |
| Rated conventional heating current $I_{th}(A)\theta\leq 40$         |           |      | 160  | 185     | 215     |
| Rated operational current (A)                                       | 380V/400V | AC-1 | 160  | 185     | 215     |
|   |           | AC-3 | 115  | 150     | 185     |
|   | 660V/690V | AC-4 | 54   | 68      | 81      |
|   |           | AC-3 | 115  | 150     | 170     |
|   | 1000V     | AC-4 | 48   | 57      | 65      |
|   |           | AC-3 | 53   | 65      | 65      |
|   |           | AC-4 | 34   | 38      | 42      |
| Rated insulation voltage $U_e(V)$                                   |           |      | 1000   |         |         |
| Control rated power of 3-phase motor(kW)                            | 380V/400V | AC-3 | 55   | 75      | 90      |
|   |           | AC-4 | 30   | 37      | 45      |
|   | 660V/690V | AC-3 | 110  | 132     | 160     |
|   |           | AC-4 | 50   | 55      | 63      |
|   | 1000V     | AC-3 | 75   | 90      | 90      |
|   |           | AC-4 | 50   | 55      | 63      |
| Electrical durability ( $\times 10^4$ cycles)                       | 380V/400V | AC-3 | 100  |         |         |
|   |           | AC-4 | 20   | 20      | 20      |
| Holding power(VA)   |           |      | 10   |         |         |
| Control voltage(V) AC/DC  |           |      | 24,36,42,48,110,127,220,230,240,380,400,415  |         |         |
| Auxiliary contacts  |           |      | 2NO+2NC  |         |         |
| Dimension(L×W×H)(mm)  |           |      | 173×120×174  |         |         |
| Weight(Kg)  |           |      | 3  |         |         |
| Matched thermal overload relay                                      |           |      |  |         |         |
| Models  |           |      | Ex9R185  |         |         |
| Matched mechanical interlocking device                              |           |      |  |         |         |
| Models  |           |      | MIT44  |         |         |
| Add-on auxiliary contact blocks: Use categories for AC-15 and DC-13 |           |      |  |         |         |
| Top mounting  | 4NC       |      | AX4204   |         |         |
|   | 1NO+3NC   |      | AX4213   |         |         |
|   | 2NO+2NC   |      | AX4222   |         |         |
|   | 3NO+1NC   |      | AX4231   |         |         |
|   | 4NO       |      | AX4240   |         |         |
|   | 2NC       |      | AX4202   |         |         |
|   | 1NO+1NC   |      | AX4211   |         |         |
|   | 2NO       |      | AX4220   |         |         |
|   | 1NO+1NC   |      | AX4411   |         |         |
| Side mounting   | 2NC       |      | AX4402   |         |         |
|   | 2NO       |      | AX4420   |         |         |

| Ex9C225   |     | Ex9C265 |     | Ex9C300 |   | Ex9C400 |  | Ex9C500 |  |
|---|-----|---------|-----|---------|---|---------|--|---------|--|
|  |     |         |     |         |  |         |  |         |  |
| 3P  |     |         |     |         | 3P  |         |  |         |  |
| 50/60   |     |         |     |         | 50/60   |         |  |         |  |
| 275   | 330 | 330     | 330 | 430     | 610   |         |  |         |  |
| 275   | 330 | 330     | 330 | 430     | 610   |         |  |         |  |
| 225   | 265 | 300     | 300 | 400     | 500   |         |  |         |  |
| 96  | 117 | 125     | 125 | 150     | 175   |         |  |         |  |
| 225   | 265 | 280     | 280 | 400     | 450   |         |  |         |  |
| 85  | 105 | 115     | 115 | 135     | 150   |         |  |         |  |
| 68  | 95  | 95      | 95  | 180     | 200   |         |  |         |  |
| 42  | 57  | 57      | 57  | 80      | 80  |         |  |         |  |
| 1000  |     |         |     |         | 1000  |         |  |         |  |
| 110   | 132 | 160     | 160 | 220     | 250   |         |  |         |  |
| 55  | 63  | 75      | 75  | 90      | 100   |         |  |         |  |
| 200   | 250 | 250     | 250 | 355     | 400   |         |  |         |  |
| 80  | 100 | 110     | 110 | 132     | 150   |         |  |         |  |
| 90  | 132 | 132     | 132 | 250     | 315   |         |  |         |  |
| 63  | 80  | 80      | 80  | 110     | 110   |         |  |         |  |
| 100   |     |         |     |         | 100   |         |  |         |  |
| 20  | 20  | 20      | 20  | 20      | 20  |         |  |         |  |
| 10  |     |         |     |         | 10  |         |  |         |  |
| 24,36,42,48,110,127,220,230,240,380,400,415                                       |     |         |     |         | 24,36,42,48,110,127,220,230,240,380,400,415   |         |  |         |  |
| 2NO+2NC   |     |         |     |         |   |         |  |         |  |
| 213x145x208   |     |         |     |         | 216x160x229   |         |  |         |  |
| 6   |     |         |     |         | 9.5   |         |  |         |  |
| Ex9R500   |     |         |     |         | Ex9R500   |         |  |         |  |
| MIT44   |     |         |     |         | MIT44   |         |  |         |  |
| AX4204  |     |         |     |         | AX4204  |         |  |         |  |
| AX4213  |     |         |     |         | AX4213  |         |  |         |  |
| AX4222  |     |         |     |         | AX4222  |         |  |         |  |
| AX4231  |     |         |     |         | AX4231  |         |  |         |  |
| AX4240  |     |         |     |         | AX4240  |         |  |         |  |
| AX4202  |     |         |     |         | AX4202  |         |  |         |  |
| AX4211  |     |         |     |         | AX4211  |         |  |         |  |
| AX4220  |     |         |     |         | AX4220  |         |  |         |  |
| AX4411  |     |         |     |         | AX4411  |         |  |         |  |
| AX4402  |     |         |     |         | AX4402  |         |  |         |  |
| AX4420  |     |         |     |         | AX4420  |         |  |         |  |





## Parameters

| Ex9Ci Low Energy Consumption Contactor          |                    |                | Ex9C09i   | Ex9C12i | Ex9C18i | Ex9C25i   | Ex9C32i | Ex9C38i |
|---|--------------------|----------------|---|---------|---------|---|---------|---------|
| Low Energy Consumption AC Contactor             |                    |                |  |         |         |  |         |         |
| Electrical performance                          |                    |                |   |         |         |   |         |         |
| Operation frequency(Hz)                         |                    |                | 50/60   |         |         | 50/60   |         |         |
| Rated conventional heating current $I_{th}$ (A) |                    |                | 25  |         | 32      | 40  | 50      |         |
| Rated operational current (A)                   | AC-1               |                | 25  |         | 32      | 40  | 50      |         |
|   | 380V/400V          | AC-2/AC-3/AC-4 | 9   | 12      | 18      | 25  | 32      | 38      |
|   |                    | AC-3           | 6.7   | 9       | 10.6    | 17.3  | 21.9    |         |
| 660V/690V                                       | AC-4/AC-2          | 4.9            |   | 6.7     | 14      | 17.3  |         |         |
| Rated insulation voltage $U_i$ (V)              |                    |                | 690   |         |         | 690   |         |         |
| Rated control power 3-phase motor(kW)           | 380V/400V          | AC-3/AC-4      | 4   | 5.5     | 7.5     | 11  | 15      | 18.5    |
|   |                    | AC-3           | 5.5   | 7.5     | 9       | 15  | 18.5    |         |
|   | 660V/690V          | AC-4           | 4   |         | 5.5     | 11  | 15      |         |
| Electrical durability ( $\times 10^3$ cycles)   | 380V/400V          | AC-3           | 1200  |         |         | 1200  |         |         |
|   |                    | AC-4           | 50  | 40      |         | 50  | 40      |         |
| Machinery durability ( $\times 10^6$ cycles)    |                    |                | 10  |         |         | 10  |         |         |
| Connection and installation                     |                    |                |   |         |         |   |         |         |
| Auxiliary contacts                              |                    |                | 1NO+1NC/2NO+2NC   |         |         | 1NO+1NC/2NO+2NC   |         |         |
| Mounting type                                   | Screw installation |                | Details See Instruction   |         |         |   |         |         |
|   | Rail installation  |                | DIN Rail(35mm)  |         |         | DIN Rail(35mm)  |         |         |
| Dimension(L×W×H)(mm)                            |                    |                | 45×89×94  |         |         | 45×100×108  |         |         |
| Weight(Kg)                                      |                    |                | 0.35  |         |         | 0.4   |         |         |
| Holding power(VA)                               |                    |                | 2.4   |         |         | 2.4   |         |         |
| Control voltage(V) AC/DC                        |                    |                | DC: 12,24,48,110,220  |         |         |   |         |         |
| Safety zone(mm)                                 |                    |                | 3   |         |         | 5   |         |         |
| Matched thermal overload relay                  |                    |                |   |         |         |   |         |         |
| Models  |                    |                | Ex9R38  |         |         | Ex9R38  |         |         |
| Matched mechanical interlocking device          |                    |                |   |         |         |   |         |         |
| Models  |                    |                | MIT42   |         |         | MIT42   |         |         |
| Add-on auxiliary contact blocks                 |                    |                |   |         |         |   |         |         |
| Top mounting                                    | 4NC                |                |   |         |         | AX4204  |         |         |
|   | 1NO+3NC            |                |   |         |         | AX4213  |         |         |
|   | 2NO+2NC            |                |   |         |         | AX4222  |         |         |
|   | 3NO+1NC            |                |   |         |         | AX4231  |         |         |
|   | 4NO                |                |   |         |         | AX4240  |         |         |
|   | 2NC                |                |   |         |         | AX4202  |         |         |
|   | 1NO+1NC            |                |   |         |         | AX4211  |         |         |
|   | 2NO                |                |   |         |         | AX4220  |         |         |
| Side mounting                                   | 1NO+1NC            |                |   |         |         | AX4311  |         |         |



## Parameters

| Ex9Ci Low Energy Consumption Contactor          |                    |                | Ex9C40i   | Ex9C50i | Ex9C65i                       | Ex9C80i   | Ex9C100i |
|---|--------------------|----------------|---|---------|-------------------------------|---|----------|
| Low Energy Consumption AC Contactor             |                    |                |  |         |                               |  |          |
| Electrical performance                          |                    |                |   |         |                               |   |          |
| Operation frequency(Hz)                         |                    |                | 50/60   |         |                               | 50/60   |          |
| Rated conventional heating current $I_{th}$ (A) |                    |                | 60  | 80      |                               | 125   |          |
| Rated operational current (A)                   | AC-1               |                | 60  | 80      |                               | 125   |          |
|   | 380V/400V          | AC-2/AC-3/AC-4 | 40  | 50      | 65                            | 80  | 100      |
|   |                    | AC-3           | 34  | 39      | 42                            | 49  |          |
| 660V/690V                                       | AC-4/AC-2          | 34             | 39  | 42      | 49                            |   |          |
|   |                    |                | 1000  |         |                               | 1000  |          |
| Rated insulation voltage $U_i$ (V)              |                    |                | 1000  |         |                               | 1000  |          |
| Rated control power 3-phase motor(kW)           | 380V/400V          | AC-3/AC-4      | 18.5  | 22      | 30                            | 37  | 45       |
|   |                    | AC-3           | 30  | 33      | 37                            | 45  |          |
|   | 660V/690V          | AC-4           | 30  | 33      | 37                            | 45  |          |
| Electrical durability ( $\times 10^3$ cycles)   | 380V/400V          | AC-3           | 1200  |         |                               | 1200  |          |
|   |                    | AC-4           | 35  | 30      |                               | 25  |          |
| Machinery durability ( $\times 10^6$ cycles)    |                    |                | 10  |         |                               | 10  |          |
| Connection and installation                     |                    |                |   |         |                               |   |          |
| Auxiliary contacts                              |                    |                | 1NO+1NC   |         |                               | 1NO+1NC   |          |
| Mounting type                                   | Screw installation |                | Details See Instruction   |         |                               |   |          |
|   | Rail installation  |                | DIN Rail(35mm)/DIN Rail(75mm)   |         | DIN Rail(35mm)/DIN Rail(75mm) |   |          |
| Dimension(L×W×H)(mm)                            |                    |                | 76×122×123  |         |                               | 87×130×130  |          |
| Weight(Kg)                                      |                    |                | 1.23  |         |                               | 1.5   |          |
| Holding power(VA)                               |                    |                | 3.6   |         |                               | 1   |          |
| Control voltage(V) AC/DC                        |                    |                | DC: 12, AC/DC: 24,48,110,220  |         |                               | DC: 12, AC/DC: 24,48,110,220,380  |          |
| Safety zone(mm)                                 |                    |                | 12  |         |                               | 12  |          |
| Matched thermal overload relay                  |                    |                |   |         |                               |   |          |
| Models  |                    |                | Ex9R100   |         |                               | Ex9R100   |          |
| Matched mechanical interlocking device          |                    |                |   |         |                               |   |          |
| Models  |                    |                | MIT43   |         |                               | MIT43   |          |
| Add-on auxiliary contact blocks                 |                    |                |   |         |                               |   |          |
| Top mounting                                    | 4NC                |                |   |         |                               | AX4204  |          |
|   | 1NO+3NC            |                |   |         |                               | AX4213  |          |
|   | 2NO+2NC            |                |   |         |                               | AX4222  |          |
|   | 3NO+1NC            |                |   |         |                               | AX4231  |          |
|   | 4NO                |                |   |         |                               | AX4240  |          |
|   | 2NC                |                |   |         |                               | AX4202  |          |
|   | 1NO+1NC            |                |   |         |                               | AX4211  |          |
|   | 2NO                |                |   |         |                               | AX4220  |          |
|   | Side mounting      | 1NO+1NC        |   |         |                               |   | AX4311   |

## Accessories

Ex9C Series AC Contactor Accessories include :  
 AX4 series auxiliary contacts, TDD series air delay head, Surge suppressor CCU series

### Conventional Contactor

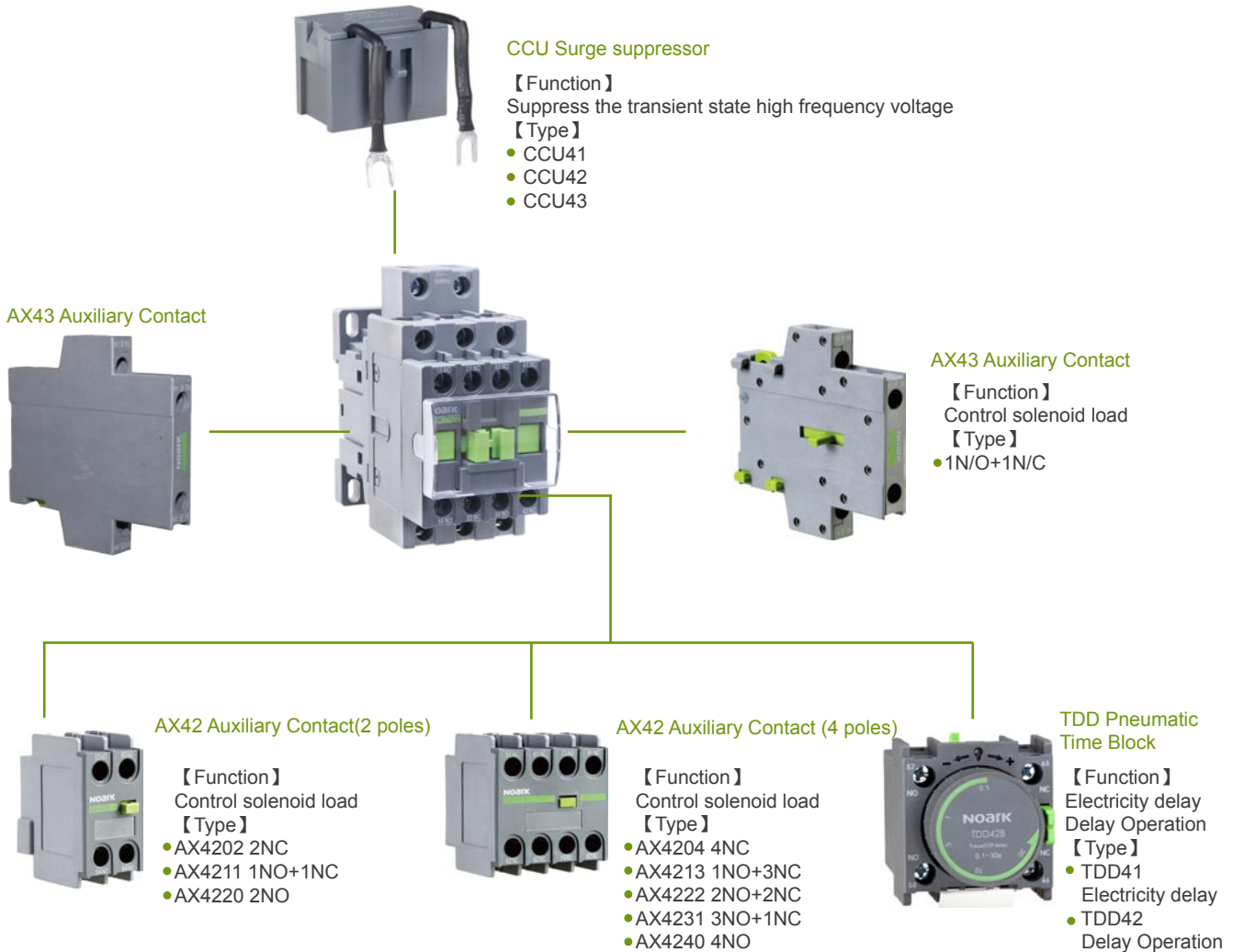

### Minitype Contactor

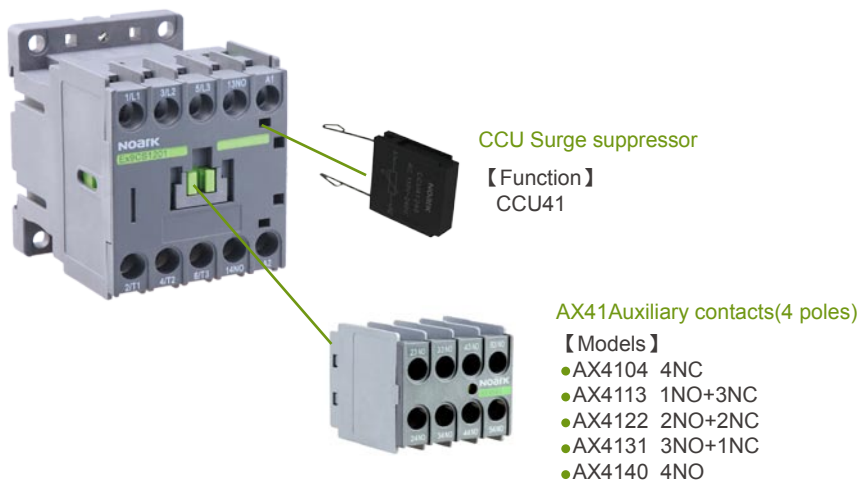



### Selection

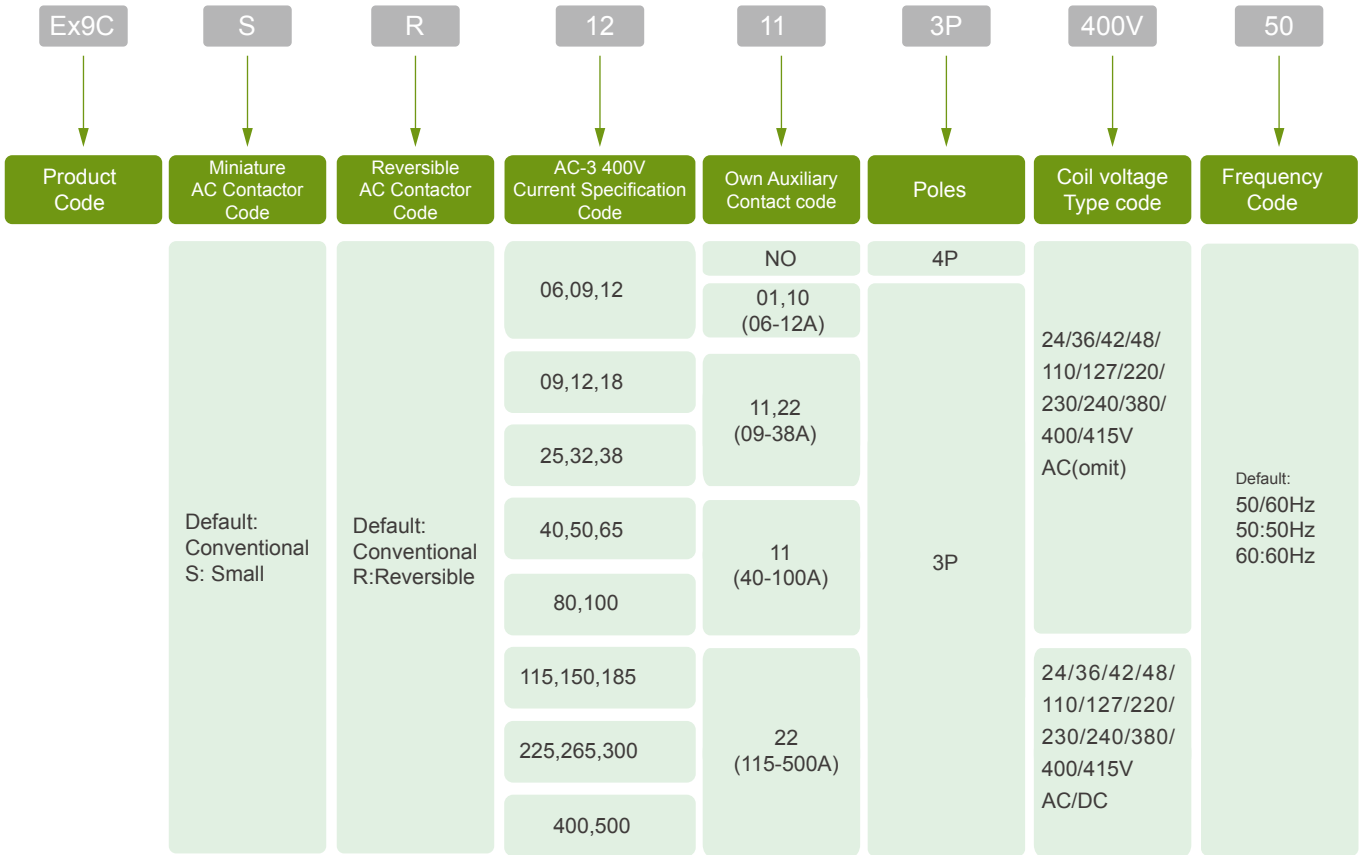

**Example:**

“Ex9CSR12 10 3P 400V 50” Means for order an In AC-3 400 V use category,frequency 50 Hz,1NO+1NC,Coil voltage AC 400 V , 3 poles, Ex9CSR series of mini-reversible AC contactor

### Pneumatic time block Selection

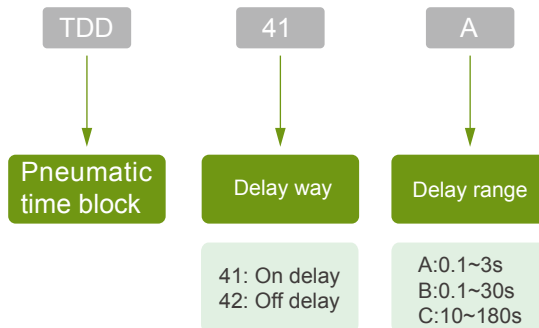

**Example:**

“TDD41A” Means for order an time delay current range of 0.1 ~ 3 s air delay contacts.

## Accessories Selection

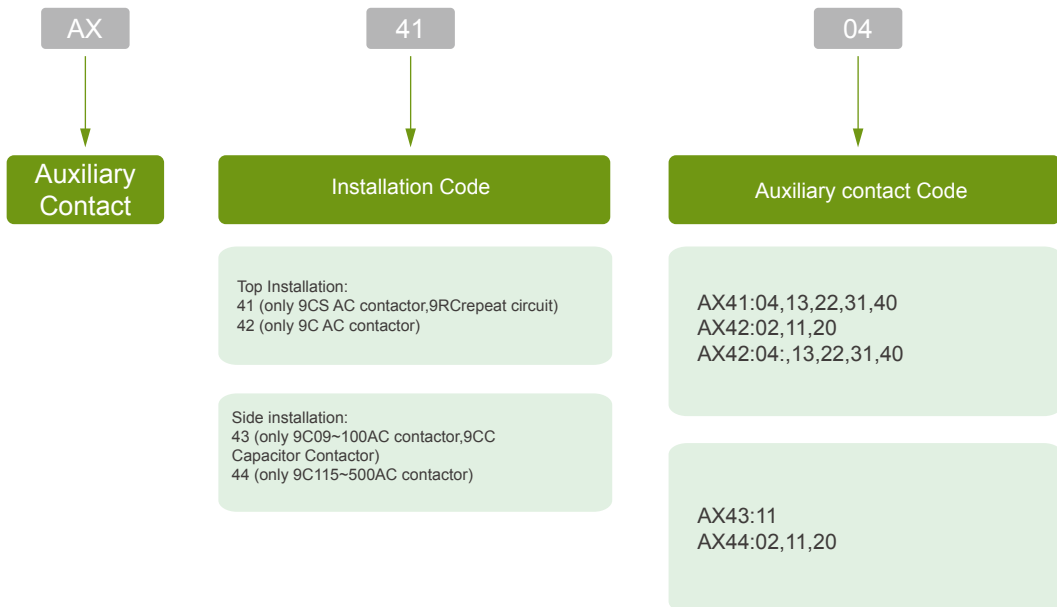

### Example:

“AX4104” Means for order an 4NC AX4 series auxiliary contacts.

## Surge suppressor versatility Selection

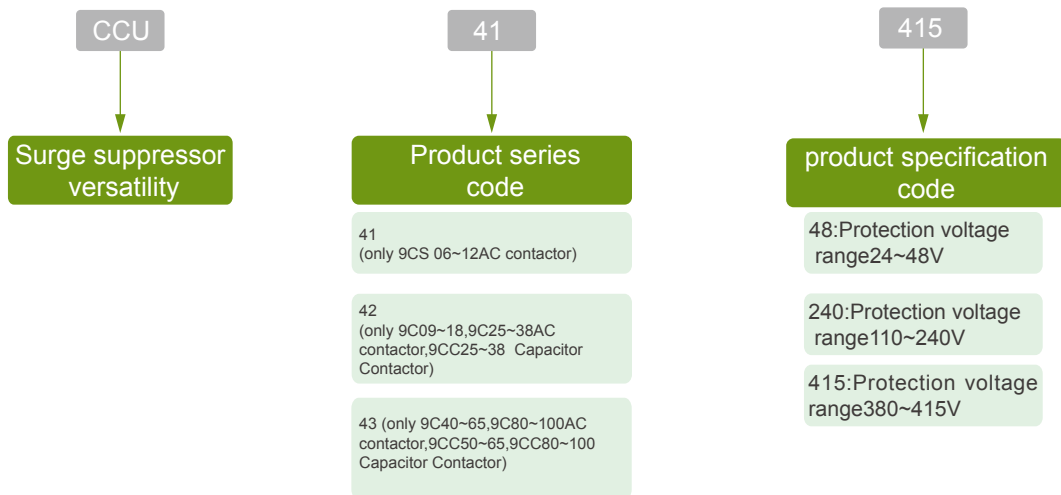

### Example:

“CCU41 415” Means for order an apply to 9CS06 ~ 12 AC contactor, and protect coil voltage range for 380 V-415 V surge suppressor.



## Selection

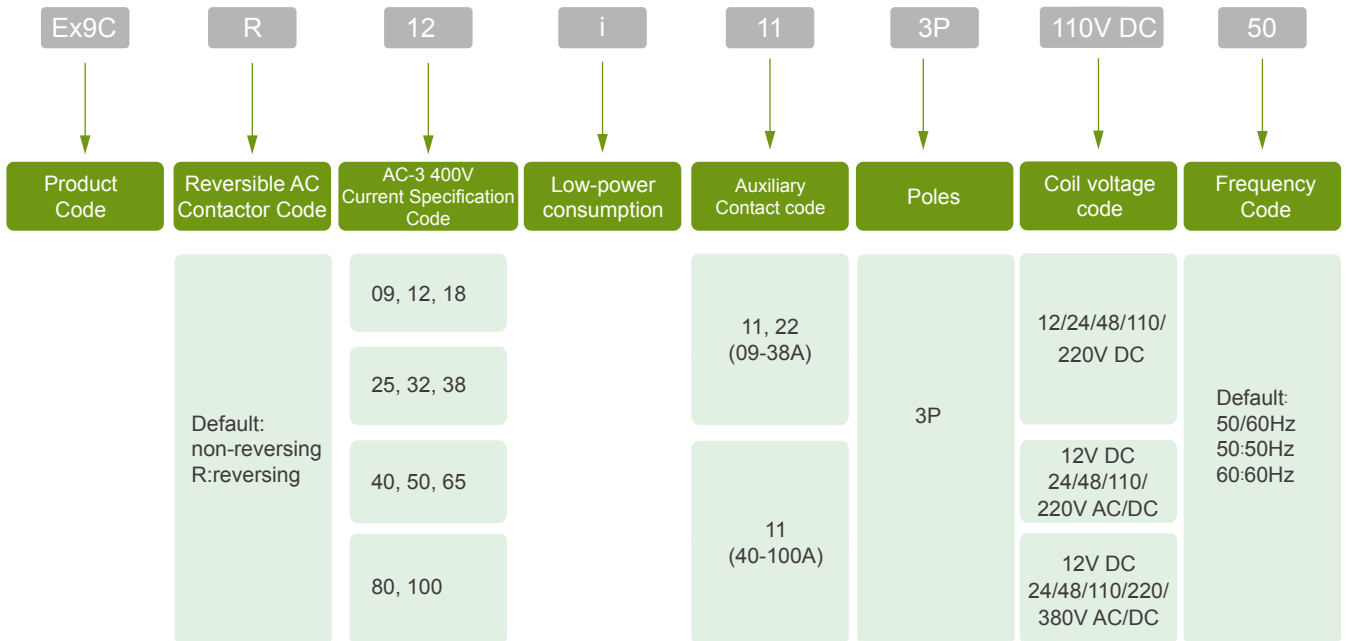

### Example:

"Ex9CR12i 11 3P 110V DC 50" stands for reversing low-consumption contactor with rated current 12A @AC-3 400V, 1NO+1NC, 3P, 50Hz



## Features



### Ex9R Series Thermal Overload Relay

- Rated current range(0.1A~100A),three frames
- Materials such as bimetal,plastic are imported
- One frame overload can use with many frames of contactor
- Function:overload protection,phase failure protection,temperature compensation etc
- Low power consumption,the max power consumption of Ex9R38 is just 4.5W
- 2 inventive patents,2 new practical patents,1 appearance patent
- Products with light weight, stable and reliable performance, exquisite appearance



| Type       | Ex9R12 | Ex9R38 | Ex9R100 |
|------------|--------|--------|---------|
| Weight(kg) | 0.16   | 0.14   | 0.51    |

- Machine with semi-automatic production line model
- Process testing, product testing, product testing and other aspects of computer control and the use of all seized by Taiwan
- Processing of the key process using laser welding, auto and other advanced manufacturing processes around the wire

### Five kinds of shell frame current level

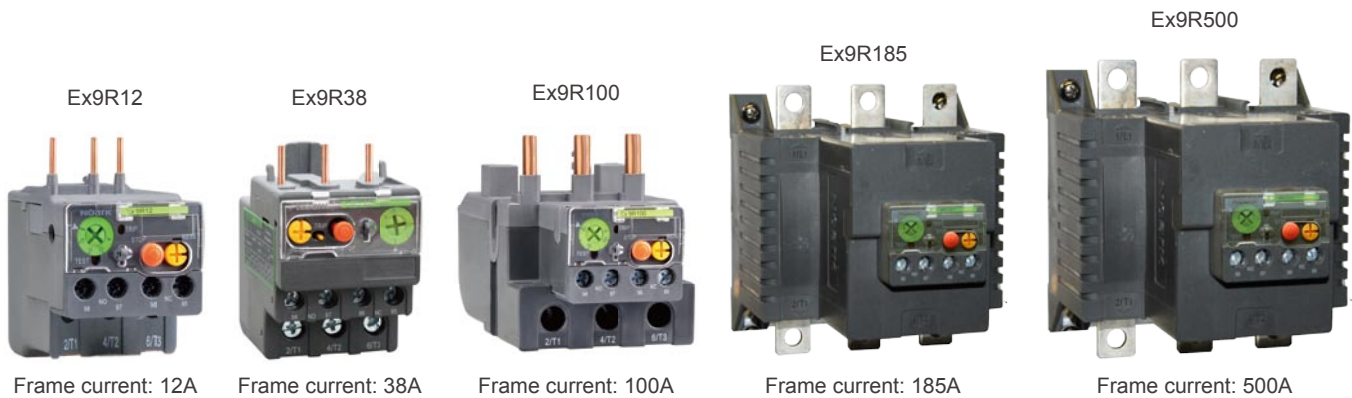



For each type of Ex9R thermal overload relays can match various types of Ex9C ac contactor,Chart:

| Ex9R Model                                      | Ex9R12  | Ex9R38 | Ex9R100 | Ex9R185 | Ex9R500 |         |         |         |
|---|---------|--------|---------|---------|---------|---------|---------|---------|
| In the Ex9C can match Flow contact device model | Ex9CS06 | Ex9C09 | Ex9C25  | Ex9C40  | Ex9C80  | Ex9C115 | Ex9C225 | Ex9C400 |
|   | Ex9CS09 | Ex9C12 | Ex9C32  | Ex9C50  | Ex9C100 | Ex9C150 | Ex9C265 | Ex9C500 |
|   | Ex9CS12 | Ex9C18 | Ex9C38  | Ex9C65  |         | Ex9C185 | Ex9C300 |         |

Note: Ex9R12 setting current range: (0.1 ~ 12) A; Ex9R38 setting current range: (2.5 ~ 38) A; Ex9R100 setting current range: (23-100) A. Ex9R185 setting current range: (80 ~ 185) A; Ex9R500 setting current range: (160 ~ 500) A.





## Parameters

| Ex9R Series Thermal Overload Relay                                | Ex9R12  | Ex9R38   | Ex9R100   |
|---|---|--|---|
| IEC 60947-4-1   |  |  |  |
| <b>Electrical performance</b>                                     |   |  |   |
| Operation frequency(Hz)   | 50/60   |  |   |
| Tripping class  | 10A   |  |   |
| Rated insulation voltage(V)                                       | 690   |  |   |
| Setting current range(A)  | 0.1~12  | 2.5~38   | 23~100  |
| Tripping threshold  | 1.14±0.06I <sub>n</sub>   |  |   |
| Sensitivity to phase failure                                      | Tripping current 30% of I <sub>n</sub> on one phase,the others at I <sub>n</sub>  |  |   |
| Protection functions  | Overload,phase failure  |  |   |
| conformed standards   | IEC 60947-4-1   |  |   |
| <b>Operational environment</b>                                    |   |  |   |
| Ambient air temperature for normal operation(°C)                  | -20~+55   |  |   |
| Mounted position  | Mounting surface and vertical plane is not more than 30 °                         |  |   |
| <b>Protection</b>   |   |  |   |
| Seismic performance<br>(accord with IEC68-2-6 allow acceleration) | 2gn-5 to 300Hz  |  |   |
| Shock resistance<br>(accord with IEC68-2-27 allow acceleration)   | 15gn-11ms   |  |   |
| Degree of protection  | IP20  |  |   |
| Protection degree   | "TH"  |  |   |
| <b>Outline structure</b>  |   |  |   |
| Reset   | Manual or Automatic   |  |   |
| Auxiliary contact   | 1NO+1NC   |  |   |
| Dimension (L xW xH) (mm)  |   | 65×46×69   | 117×72×80   |
| Weight (kg)   | 0.16  | 0.14   | 0.51  |
| <b>Matched contactor</b>  |   |  |   |
| Model   | Ex9CS06,09,12   | Ex9C09,12,18,25,32,38  | Ex9C40,50,65,80,100   |
| <b>Matched mounting base</b>                                      |   |  |   |
| Model   | AD51  | AD52   | AD53  |



## Parameters

| Ex9R Series Thermal Overload Relay                                | Ex9R185   | Ex9R500   |
|---|---|---|
| IEC 60947-4-1   |  |  |
| <b>Electrical performance</b>                                     |   |   |
| Operation frequency(Hz)   | 50/60   |   |
| Tripping class  | 10A   |   |
| Rated insulation voltage(V)                                       | 690   |   |
| Setting current range(A)  | 80~185  | 160~500   |
| Tripping threshold  | 1.14±0.06I <sub>n</sub>   |   |
| Sensitivity to phase failure                                      | Tripping current 30% of I <sub>n</sub> on one phase,the others at I <sub>n</sub>  |   |
| Protection functions  | Overload,Phase failure  |   |
| Conformed standards   | IEC 60947-4-1   |   |
| <b>Operational environment</b>                                    |   |   |
| Ambient air temperature for normal operation( )                   | -20~+55   |   |
| Operating positions   | The angle between teh installation plane and the vertical plane is less than 30°  |   |
| <b>Protection</b>   |   |   |
| Seismic performance<br>(accord with IEC68-2-6 allow acceleration) | 2gn-5 ~ 300Hz   |   |
| Shock resistance<br>(accord with IEC68-2-27 allow acceleration)   | 15gn-11ms   |   |
| Shell protection grade  | IP20  |   |
| Protection degree   | "TH"  |   |
| <b>Outline structure</b>  |   |   |
| Reset   | Manual or Auto  |   |
| Auxiliary contact   | 1NO+1NC   |   |
| Dimension (Lx W × H) (mm)   | 136×120×133   | 146×145×149   |
| Weight (kg)   | 1.5   | 1.9   |
| <b>Matched contactor</b>  |   |   |
| Model   | Ex9C115,150,185   | Ex9C225,265,300,400,500   |
| <b>Matched mounting base</b>                                      |   |   |
| Model   | AD54  | AD55  |



## Selection



Table of setting current range

### Example:

“Ex9R12 10A” is for ordering for order A shell frame for 12 current level, setting current range for 7 A ~ 12 A, 3poles Ex9R series of thermal overload relays.

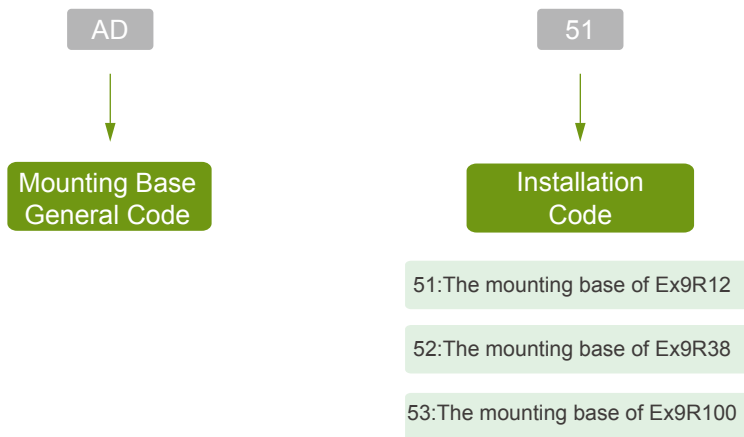

### Example:

“AD51” is for ordering for order a only applies to the Ex9R12 three extremely hot overload relays installed base.



## Overview

The product is used for breaking the capacitor bank in low voltage reactive compensation, whose rated working voltage is 690V, utilization category is AC-6b in the power system. It is for connecting and breaking the power capacitor whose shunt capacitance points to 90k Var and to adjust electric power system for numerical. The contactor with current suppression device can effectively reduce the current impact of the capacitors and operational over voltage.

Ex9CC has three shell frame current levels, six types:



## Standards and Certifications

IEC/EN 60947-4-1

## Operating Conditions

### Temperature

- May be used in temperatures from -20 - +40



### Altitude

- Normally, the altitude above sea level at its installation site must not exceed 2,000 m.

### Humidity

The following conditions must be met during normal operation:

- If the ambient air temperature is +40°C, the atmospheric relative humidity can not exceed 50%. If the temperature is lower, use it under the conditions for a higher degree of humidity
- The monthly mean relative humidity needs to be below 90% in the dampest month
- The effects of condensation on the product surface impacts its performance and needs to be taken into consideration

### Pollution Level

- Level

### Installation

- Could be installed with screwing mounting
- Could be installed with card rail mounting (DIN Rail(35mm)/DIN Rail(75mm))
- The slope between mounting surface and vertical plane is less than  $\pm 5^\circ$





## Parameters

### Main contact parameters

| Ex9CC Series Capacitor Contactor                    | Ex9CC25 | Ex9CC38 | Ex9CC50 | Ex9CC65 | Ex9CC80 | Ex9CC100 |
|---|---------|---------|---------|---------|---------|----------|
| <b>Electrical performance</b>                       |         |         |         |         |         |          |
| Rated conventional heating current                  | 50      | 50      | 80      | 80      | 125     | 125      |
| Rated current                                       | 25      | 38      | 50      | 65      | 80      | 100      |
| AC-6b   | 8       | 15      | 20      | 25      | 30      | 40       |
| AC-6b   | 16      | 25      | 30      | 40      | 50      | 60       |
| Kvar  | 25      | 40      | 50      | 60      | 80      | 90       |
| Rated insulation voltage Ui(V)                      | 690     |         |         |         |         |          |
| Inhibit current ability(current limiting multiples) | 30      |         |         |         |         |          |
| Electrical durability( $\times 10^6$ cycles)        | 2       |         |         | 1       |         |          |
| Mechanical life( $\times 10^6$ cycles)              | 10      |         |         |         |         |          |
| Operation frequency(cycles/h)                       | 180     |         |         | 100     |         |          |
| Auxiliary contacts                                  | 2NO+1NC | 2NO+1NC | 2NO+1NC | 2NO+1NC | 2NO+1NC | 2NO+1NC  |
|   | 1NO+2NC | 1NO+2NC | 1NO+2NC | 1NO+2NC | 1NO+2NC | 1NO+2NC  |
|   | 3NO+2NC | 3NO+2NC | —       | —       | —       | —        |
|   | 2NO+3NC | 2NO+3NC | —       | —       | —       | —        |

### Auxiliary contacts Parameters

| Utilization Category                   | AC-15      | DC-13 |
|--|------------|-------|
| Rated conventional heating current (A) | 10         |       |
| Rated voltage (V)                      | 415        | 250   |
| Rated current (A)                      | 1.9        | 0.31  |
| Control capacity                       | connecting | 69W   |
|  | breaking   | 69W   |

## Selection

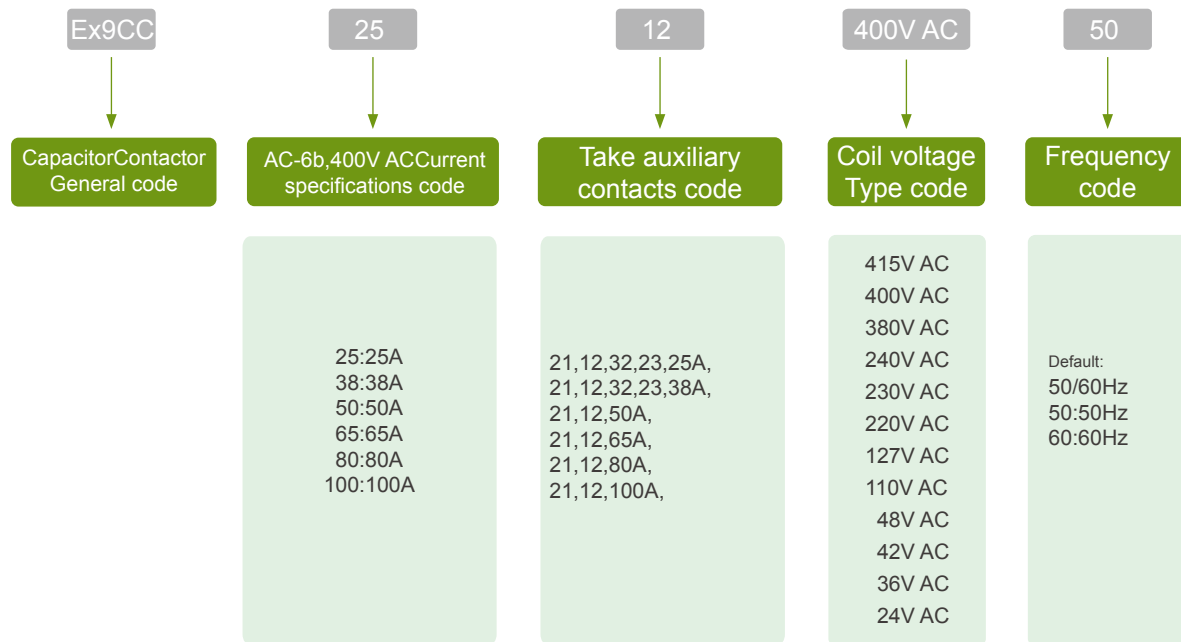

### Example:

“Ex9CC25 12 400V AC 50” is for ordering for order a in AC-400 V use category, 50 Hz, a pair of 2NC, coil voltage of AC 400 V Ex9CC series of capacitance contactor.



## Overview

It is used in the control circuit with 690V working voltage. The product is with compact structure, easy installation, small volume and has a variety of combination of the contacts.

Ex9RC 5 kinds of models:



- Ex9RC**
- Ex9RC04
  - Ex9RC13
  - Ex9RC22
  - Ex9RC31
  - Ex9RC40

## Standards and Certifications

IEC/EN 60947-5-1

## Operating Conditions

### Temperature

- May be used in temperatures from -20 - +55

### Altitude

- Normally, the altitude above sea level at its installation site must not exceed 2,000 m.

### Humidity

The following conditions must be met during normal operation:

- If the ambient air temperature is +40°C, the atmospheric relative humidity can not exceed 50%. If the temperature is lower, use it under the conditions for a higher degree of humidity
- The monthly mean relative humidity needs to be below 90% in the dampest month
- The effects of condensation on the product surface impacts its performance and needs to be taken into consideration

### Pollution Level

- Level

### Installation

- Could be installed with screwing mounting
- Could be installed with card rail mounting (DIN Rail(35mm))
- The slope between mounting surface and vertical plane is less than  $\pm 30^\circ$





## Parameters

| Ex9RC Series Contactor Relay                             |           | Ex9RC04/Ex9RC22/Ex9RC31/Ex9RC40  |        |
|--|-----------|--|--------|
| IEC/EN 60947-5-1   |           |  |        |
| <b>Electrical performance</b>                            |           |  |        |
| Utilization category                                     |           | AC-15  | DC-13  |
| Rated voltage $U_e$ (V)                                  |           | 415  | 250    |
| Rated current $I_e$ (A)                                  |           | 1.9  | 0.31   |
| Rated conventional heating current $I_{th}$ (A)          |           | 10   | 10     |
| Rated control capacity                                   |           | 720VA  | 69W    |
| Electrical durability( $\times 10^6$ cycles)             |           |  | 12     |
| Mechanical life( $\times 10^6$ cycles)                   |           |  | 100    |
| Rated insulation voltage $U_i$ (V)                       |           |  | 690    |
| Rated impulse withstand voltage $U_{imp}$ $U_{imp}$ (kV) |           |  | 6      |
| Shell protection grade                                   |           |  | IP20   |
| Protection degree  |           |  | 3      |
| Minimum high voltage                                     |           |  | 17V    |
| Minimum high current                                     |           |  | 5mA    |
| Coil Power(VA)   | Start     |  | 35     |
|  | Keep      |  | 7.5    |
| Action time(ms)  | Actuation |  | 6~20   |
|  | Release   |  | 4~16   |
| Root number  |           |  | 1~2    |
| wire (mm <sup>2</sup> )                                  |           |  | 1~2.5  |
| Connection screws specifications                         |           |  | M3     |
| Tighten the torque (N.m)                                 |           |  | 0.8    |
| <b>Matched auxiliary contact</b>                         |           |  |        |
| Top mounted  | 4NC       |  | AX4104 |
|  | 1NO+3NC   |  | AX4113 |
|  | 2NO+2NC   |  | AX4122 |
|  | 3NO+1NC   |  | AX4131 |
|  | 4NO       |  | AX4140 |

Note: The product size is the same as that of the Ex9CS12

## Selection

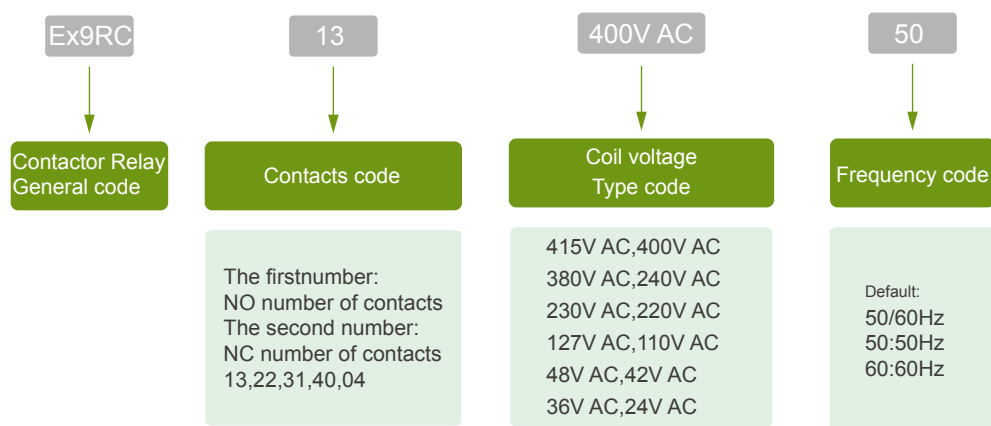

### Example:

“Ex9RC 13 400V AC 50” is for ordering an Ex9RC series Contactor Relay with frequency 50Hz, 1 NO+3NC, coil voltage of AC 400V.

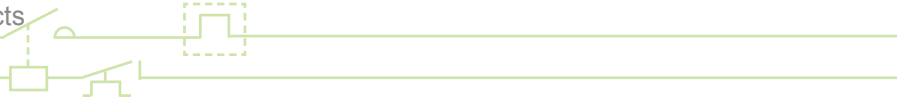

## Overview

The electromagnetic starter is a combination with contactor and relay in the same metal box. It controls connecting and breaking of the contactor according to the external switch signal in the system of AC50/60Hz,415V rated voltage,AC-3,18.5kW rated controlled power. It is used for controlling the motor as starting and stopping,and the thermal relay protects the motor from overload and loss of fase.

Ex9QC have 2 kinds of models:



Ex9QC05



Ex9QC18

## Operating Conditions

### Temperature

- May be used in temperatures from -5 - +40

### Altitude

- Normally, the altitude above sea level at its installation site must not exceed 2,000 m.

### Humidity

The following conditions must be met during normal operation:

- If the ambient air temperature is +40°C, the atmospheric relative humidity can not exceed 50%. If the temperature is lower, use it under the conditions for a higher degree of humidity
- The monthly mean relative humidity needs to be below 90% in the dampest month
- The effects of condensation on the product surface impacts its performance and needs to be taken into consideration

### Pollution Level

- The starter is generally applied in the environment of pollution level III(conductivity pollution,or the dry non-conductivity pollution changing into conductivity due to the condensation)

### Installation

- The slope between mounting surface and vertical plane is less than  $\pm 30^\circ$
- Screwing mounting,and appending corresponding spring washer and flat gasket





## Parameters

Ex9QC electromagnetic starter parameter table

| Ex9QC Series Electromagnetic Starter | Ex9QC05         | Ex9QC18  |
|--------------------------------------|-----------------|----------|
| Output of motors at 380V/415VAC      | 5.5             | 18.5     |
| Rated current (A)                    | up to 12        | up to 38 |
| Rated insulation voltage (V AC)      | 690             |          |
| Rated voltage (V AC)                 | up to 415       |          |
| Operating frequency                  | 30times/h       |          |
| Protection degree                    | IP65            |          |
| Conformed standards                  | IEC/EN60947-4-1 |          |

## Selection

| Model         | Rated current<br>Ie(A) | Rated power(kW) |             | Contactor type | Thermal relay type |
|---------------|------------------------|-----------------|-------------|----------------|--------------------|
|               |                        | Ue:380/415V     | Ue:220/240V |                |                    |
| Ex9QC05 0.16A | 0.16                   | 0.04            | 0.03        | Ex9CS1210      | Ex9R12 0.16A       |
| Ex9QC05 0.25A | 0.25                   | 0.06            | 0.04        |                | Ex9R12 0.25A       |
| Ex9QC05 0.4A  | 0.4                    | 0.09            | 0.06        |                | Ex9R12 0.4A        |
| Ex9QC05 0.63A | 0.63                   | 0.18            | 0.09        |                | Ex9R12 0.63A       |
| Ex9QC05 1A    | 1                      | 0.25            | 0.12        |                | Ex9R12 1A          |
| Ex9QC05 1.6A  | 1.6                    | 0.55            | 0.25        |                | Ex9R12 1.6A        |
| Ex9QC05 2.5A  | 2.5                    | 0.75            | 0.37        |                | Ex9R12 2.5A        |
| Ex9QC05 4A    | 4                      | 1.1             | 0.55        |                | Ex9R12 4A          |
| Ex9QC05 6A    | 6                      | 2.2             | 1.1         |                | Ex9R12 6A          |
| Ex9QC05 8A    | 8                      | 3               | 1.5         |                | Ex9R12 8A          |
| Ex9QC05 10A   | 10                     | 4               | 2.2         |                | Ex9R12 10A         |
| Ex9QC05 12A   | 12                     | 5.5             | 3           |                | Ex9R12 12A         |
| Ex9QC18 4A    | 4                      | 1.5             | 0.75        |                | Ex9C1811           |
| Ex9QC18 6A    | 6                      | 2.2             | 1.1         | Ex9R38 6A      |                    |
| Ex9QC18 8A    | 8                      | 3               | 1.5         | Ex9R38 8A      |                    |
| Ex9QC18 10A   | 10                     | 4               | 2.2         | Ex9R38 10A     |                    |
| Ex9QC18 13A   | 13                     | 5.5             | 3           | Ex9R38 13A     |                    |
| Ex9QC18 18A   | 18                     | 7.5             | 4           | Ex9R38 18A     |                    |
| Ex9QC18 24A   | 24                     | 11              | 5.5         | Ex9C3811       | Ex9R38 24A         |
| Ex9QC18 32A   | 32                     | 15              | 7.5         |                | Ex9R38 32A         |
| Ex9QC18 38A   | 38                     | 18.5            | 9           |                | Ex9R38 38A         |



## Selection

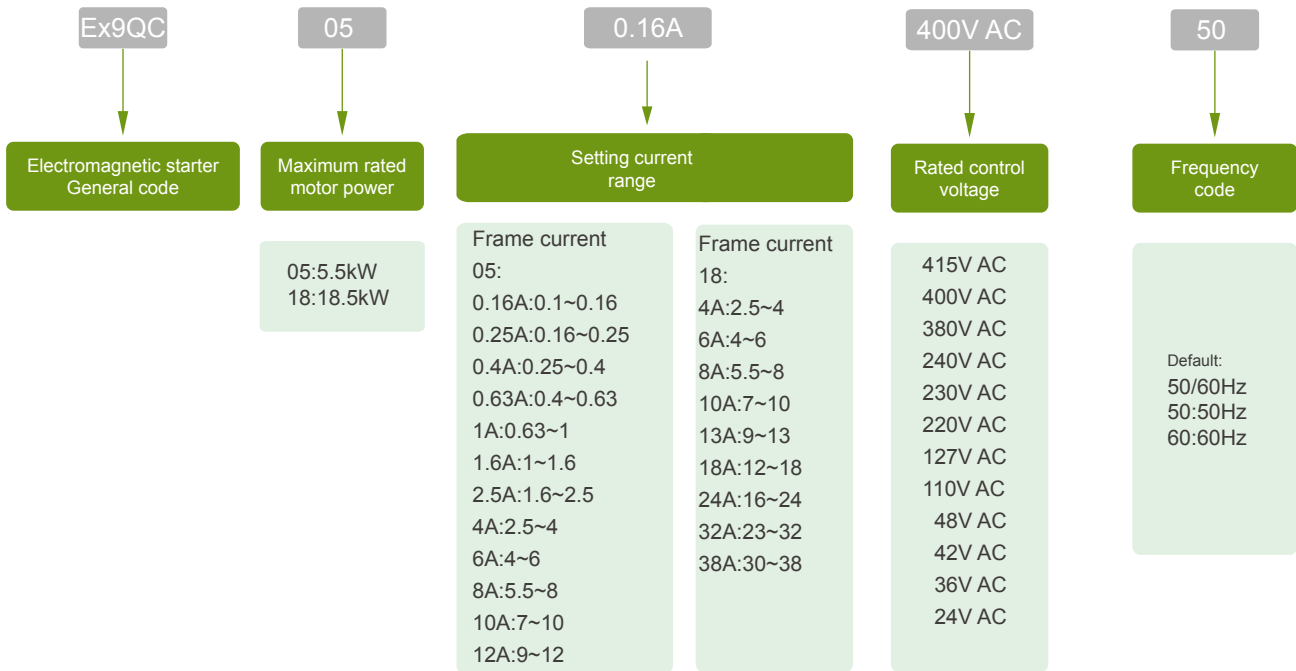



## Overview

Star-Delta starters are applicable to the circuit of AC 50/60HZ, rated control voltage up to 415V, rated power up to 85KW (rated current to 160A), for the control of "star-delta" start and stop of three-phase squirrel cage induction motor. The starter winding of the motor can transform from "Y" connection to "Δ" connection automatically, by which to reduce the starting current of motor and reduce the impact to the power grid.

Ex9QS have four shell frame current levels, 11 models:



Frame current: 18A

Ex9QS09  
Ex9QS12  
Ex9QS18



Frame current: 38A

Ex9QS25  
Ex9QS32  
Ex9QS38



Frame current: 65A

Ex9QS40  
Ex9QS50  
Ex9QS65



Frame current: 65A

Ex9QS80  
Ex9QS100

## Operating Conditions

### Temperature

- May be used in temperatures from -5 - +40

### Altitude

- Normally, the altitude above sea level at its installation site must not exceed 2,000 m.

### Humidity

The following conditions must be met during normal operation:

- If the ambient air temperature is +40°C, the atmospheric relative humidity can not exceed 50%. If the temperature is lower, use it under the conditions for a higher degree of humidity
- The monthly mean relative humidity needs to be below 90% in the dampest month
- The effects of condensation on the product surface impacts its performance and needs to be taken into consideration

### Pollution Level

- The starter is generally applied in the environment of pollution level III (conductivity pollution, or the dry non-conductivity pollution changing into conductivity due to the condensation)

### Installation

- The slope between mounting surface and vertical plane is less than  $\pm 30^\circ$
- Screwing mounting, and appending corresponding spring washer and flat gasket





## Parameters

Ex9QS series star-delta starter parameter table

| Ex9QS Series Star-delta motor starters                  | Ex9QS09                                     | Ex9QS12 | Ex9QS18 | Ex9QS25 | Ex9QS32 | Ex9QS38 | Ex9QS40 | Ex9QS50 | Ex9QS65 | Ex9QS80 | Ex9QS100 |
|---|---|---------|---------|---------|---------|---------|---------|---------|---------|---------|----------|
| Output of motors at 380V/415V (kW)                      | 7.5   | 9       | 15      | 18.5    | 25      | 30      | 33      | 45      | 59      | 75      | 85       |
| Rated current(A)  | 15.5  | 20      | 31      | 43      | 55      | 65      | 69      | 86      | 112     | 138     | 160      |
| rated insulation voltage VAC                            | 690   |         |         |         |         |         | 1000    |         |         |         |          |
| Rated voltage VAC                                       | To 415                                      |         |         |         |         |         |         |         |         |         |          |
| Electrical durabilityAC-3 380V(×10 <sup>6</sup> cycles) | 0.5   |         |         | 0.4     |         |         | 0.3     |         |         | 0.3     |          |
| Mechanical life (×10 <sup>6</sup> cycles)               | 3   |         |         |         |         |         |         |         |         |         |          |
| Conformed standards                                     | IEC/EN60947-4-1                             |         |         |         |         |         |         |         |         |         |          |
| Coil VoltageU <sub>s</sub> (V)                          | 24,36,42,48,110,127,220,230,240,380,400,415 |         |         |         |         |         |         |         |         |         |          |

## Selection

| Specification | Rated voltage U <sub>e</sub> (V) | Rated current I <sub>e</sub> (A) | Rated power P <sub>e</sub> (kW) | Rated insulation voltage U <sub>i</sub> (V) | Ac contactor             |            | Pneumatic Time Block |          |           |          |        |          |        |          |        |          |        |
|---------------|----------------------------------|----------------------------------|---------------------------------|---|--------------------------|------------|----------------------|----------|-----------|----------|--------|----------|--------|----------|--------|----------|--------|
|               |                                  |                                  |                                 |   | Lord, triangle (KM1,KM2) | Star (KM3) |                      |          |           |          |        |          |        |          |        |          |        |
| Ex9QS09       | 220/240                          | 15.5                             | 4                               | 690   | Ex9C0911                 | Ex9C0911   | TDD41B               |          |           |          |        |          |        |          |        |          |        |
|               | 380/415                          |                                  | 7.5                             |   |                          |            |                      |          |           |          |        |          |        |          |        |          |        |
| Ex9QS12       | 220/240                          | 20                               | 5.5                             |   | 690                      | Ex9C1211   |                      | Ex9C0911 | TDD41B    |          |        |          |        |          |        |          |        |
|               | 380/415                          |                                  | 9                               |   |                          |            |                      |          |           |          |        |          |        |          |        |          |        |
| Ex9QS18       | 220/240                          | 31                               | 7.5                             |   |                          | 690        |                      | Ex9C1811 |           | Ex9C1211 | TDD41B |          |        |          |        |          |        |
|               | 380/415                          |                                  | 15                              |   |                          |            |                      |          |           |          |        |          |        |          |        |          |        |
| Ex9QS25       | 220/240                          | 43                               | 11                              |   |                          |            |                      | 690      |           | Ex9C2511 |        | Ex9C1211 | TDD41B |          |        |          |        |
|               | 380/415                          |                                  | 18.5                            |   |                          |            |                      |          |           |          |        |          |        |          |        |          |        |
| Ex9QS32       | 220/240                          | 55                               | 15                              |   |                          |            |                      |          |           | 690      |        | Ex9C3211 |        | Ex9C2511 | TDD41B |          |        |
|               | 380/415                          |                                  | 25                              |   |                          |            |                      |          |           |          |        |          |        |          |        |          |        |
| Ex9QS38       | 220/240                          | 65                               | 18.5                            |   |                          |            |                      |          |           |          |        | 690      |        | Ex9C3811 |        | Ex9C2511 | TDD41B |
|               | 380/415                          |                                  | 30                              |   |                          |            |                      |          |           |          |        |          |        |          |        |          |        |
| Ex9QS40       | 220/240                          | 69                               | 18.5                            | 1000  |                          |            | Ex9C4011             |          |           |          |        |          |        | Ex9C4011 |        | TDD41B   |        |
|               | 380/415                          |                                  | 33                              |   |                          |            |                      |          |           |          |        |          |        |          |        |          |        |
| Ex9QS50       | 220/240                          | 86                               | 25                              |   | 1000                     |            | Ex9C5011             |          | Ex9C4011  |          |        |          |        | TDD41B   |        |          |        |
|               | 380/415                          |                                  | 45                              |   |                          |            |                      |          |           |          |        |          |        |          |        |          |        |
| Ex9QS65       | 220/240                          | 112                              | 30                              |   |                          | 1000       | Ex9C6511             |          | Ex9C4011  |          | TDD41B |          |        |          |        |          |        |
|               | 380/415                          |                                  | 59                              |   |                          |            |                      |          |           |          |        |          |        |          |        |          |        |
| Ex9QS80       | 220/240                          | 138                              | 40                              |   |                          |            | 1000                 | Ex9C8011 | Ex9C5011  |          |        |          | TDD41B |          |        |          |        |
|               | 380/415                          |                                  | 75                              |   |                          |            |                      |          |           |          |        |          |        |          |        |          |        |
| Ex9QS100      | 220/240                          | 160                              | 45                              |   |                          |            |                      | 1000     | Ex9C10011 | Ex9C6511 |        |          |        |          | TDD41B |          |        |
|               | 380/415                          |                                  | 85                              |   |                          |            |                      |          |           |          |        |          |        |          |        |          |        |





## Selection

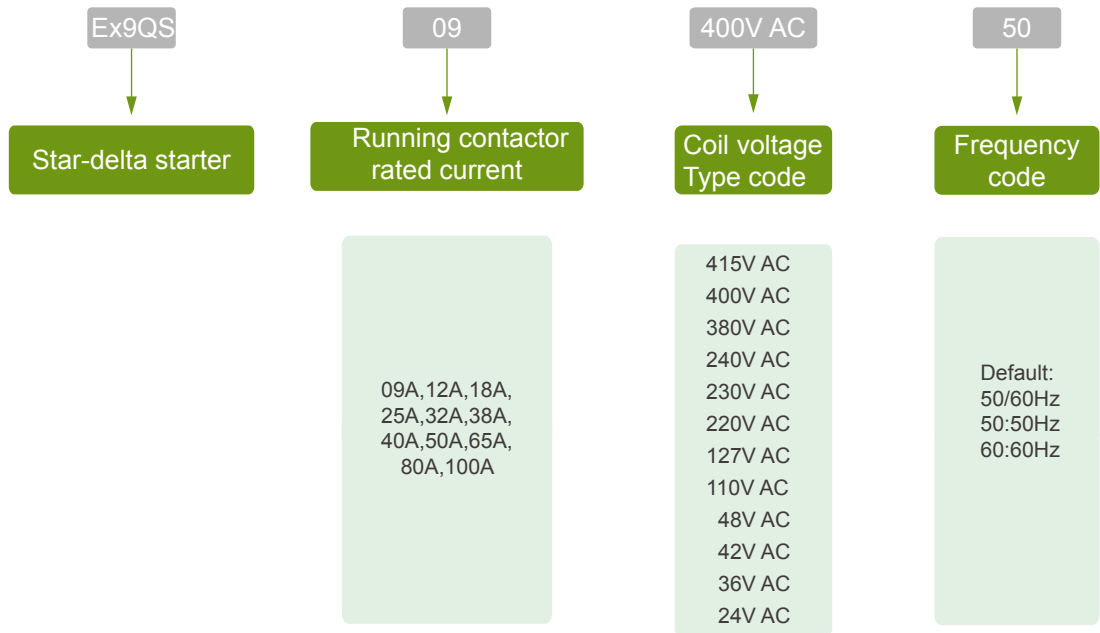

### Example:

"Ex9QS09 400V AC 50" is for ordering an Ex9QS series star-delta motor starter with frequency 50Hz, rated current of contactor 09A, coil voltage AC400V.

## Product Overview



### PVBx Series Photovoltaic Combiner Box

PVBx series PV combiner box functions of combining circuit and surge protection between PV modules and inverters.

### PVBx Z Series Smart Photovoltaic Combiner Box

PVBX Z series intelligent PV combiner box could upload and monitor the status of current, voltage, switch and SPD. Electrical data is displayed by LED and transferred by the means of RS485

## Advantages

ALL components are PV specialized by Noark, voltage of which is up to 1000VDC

Different size of combiner box and different solution to meet different demands of customers.

Number of mounting units are from 1 to 20.

Protection degree of IP 65

## Selection

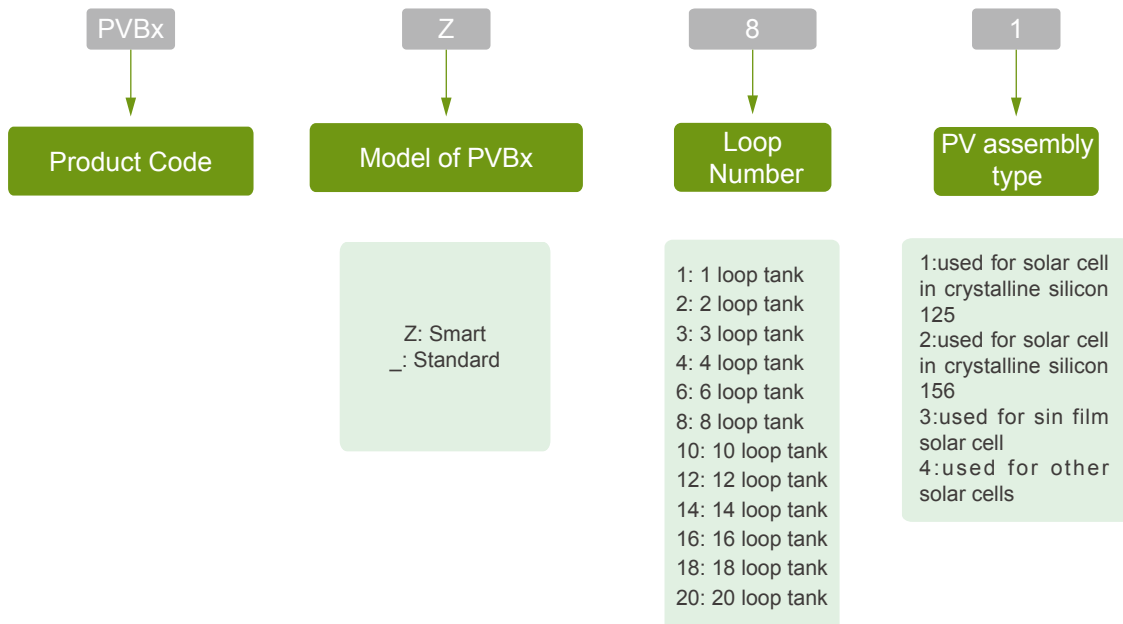



## Parameter

| Model                                 | Standard | Smart   |
|---------------------------------------|----------|---|
| <b>Electrical performance</b>         |          |   |
| Voltage range of PV array(V DC)       |          | 1000  |
| Max.string input in parallel          |          | 20  |
| Max.current of each fuse input(A)     |          | 15  |
| Max diameter of each input cable(mm)  |          | 6.5   |
| Max diameter of each output cable(mm) |          | 17  |
| <b>Protection function</b>            |          |   |
| Input fuse/breaker for PV DC          |          | ■   |
| Output breaker for PV DC              |          | ■   |
| Lightning protection module for PV    |          | ■   |
| preventing reverse current            |          | □   |
| <b>Environmental Adaptability</b>     |          |   |
| Protection degree                     |          | IP65  |
| Relative humidity                     |          | 0~99%   |
| Installation temperature              |          | -25~+70   |
| Anti-corrosion                        |          | corrosin of rain,hail and snow                    |
| Temperature resistance(Box)           |          | -40(oc)to +120(oc)                                |
| Position-free materials               |          | exclusive of silicon and halogen                  |
| Flame retardant                       |          | conform to IEC 60695-2-11,UL Subject 94V-2        |
| Chemical resistance                   |          | Prevent 10% of acid,alkali,gasoline and heavy oil |
| UV resistance                         |          | UV resistance tested for outdoor installation     |
| Degree of resistance to impact        |          | Degree of resistance to impact IK08(5 Joule)      |
| <b>Smart communication</b>            |          |   |
| Communication interface               | —        | RS485   |
| Each circuit current measurement      | —        | ■   |
| Voltage measurement system            | —        | ■   |
| Switch state upload                   | —        | □   |
| Surge protector state upload          | —        | □   |
| Temperature measurement inside box    | —        | □   |
| Alarm                                 | —        | □   |

■ Standard □ Optional — None

Monitoring string current and voltage, providing the Modbus RTU output, making combiner box "smart".

- Standardized products, 4~20strings, the same dimensions of all products
- Double-layer wiring, large aperture thread design
- Easy installation, simple operation
- High accuracy:  $\pm 1\%RDG+2DGT$
- Low-power consumption
- Relay signal output function
- With power-supply module PVP, the monitoring device SUP could be supplied by PV power instead of grid



SUP



Power-supply module

### Selection of monitoring device

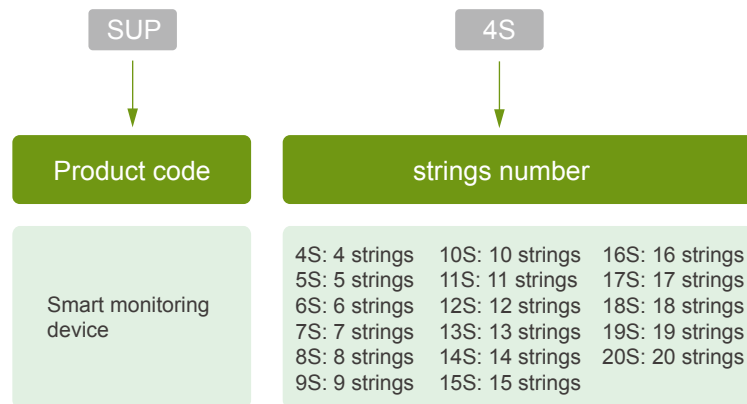

### Selection of power-supply module

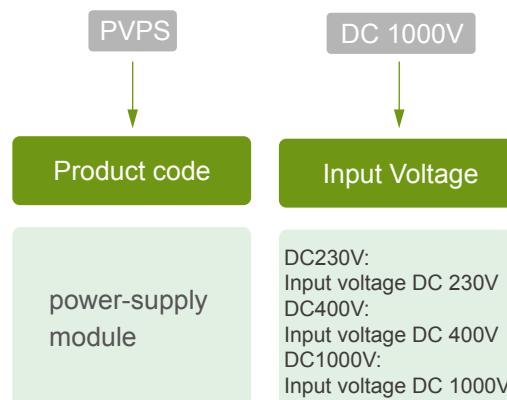



| Electrical Specification for Monitoring device | ELECTRICAL SPECIFICATION                                    |  |
|--|---|--|
| <b>Power</b>                                   |   |  |
| Input Power                                    | 24VDC, 350mA, Required (not included)                       |  |
| Max. Power Consumption (W)                     | 8(Input Voltage 24VDC, 20 Channels)                         |  |
| <b>Monitoring</b>                              |   |  |
| Max. Quantity of Channels                      | 20  |  |
| Maxi. String Current (A)                       | 20  |  |
| Range of Current Monitoring (A)                | 0.5~18 per channel  |  |
| Accuracy of Current Monitoring                 | ±(1%RDG+2DGT)   |  |
| Range of Voltage Monitoring (V)                | 100~1200  |  |
| Accuracy of Voltage Monitoring                 | ±(1%RDG+3DGT)   |  |
| <b>Output</b>                                  |   |  |
| Alarm  | Over Voltage 200V~1200V(Adjustable)                         |  |
|  | Under Voltage 50V~800V(Adjustable)                          |  |
|  | Over load protection 1.0A~18.0A(Adjustable), default 13.6A  |  |
|  | Reverse Current -18.0A~-1.0A(Adjustable)                    |  |
| Status Monitoring                              | SPD   |  |
|  | Fuse  |  |
|  | Breaker   |  |
| <b>Communication</b>                           |   |  |
| Protocols                                      | ModBus-RTU  |  |
| Baud rate                                      | 4800bps/9600bps/19200bps(Adjustable), default value 9600bps |  |
| Addressing                                     | 1~247   |  |
| Communication Distance 1200                    | 1200m(shielded twisted-pair cable)                          |  |
| <b>Environment</b>                             |   |  |
| Operation Temperature ( )                      | -25~+70   |  |
| Humidity (%)                                   | 0~95  |  |
| Storage Temperature ( )                        | 0~+85   |  |
| Altitude (m)                                   | ≤2500   |  |
| Pollution Degree                               | 2   |  |
| <b>Physical</b>                                |   |  |
| Size   | 10.25"×3.2"×2.8" (260mm×80mm×70mm)                          |  |
| Weight (kg)                                    | 0.575(Full Function, 20 Channels)                           |  |

| Electrical Specification for Power-supply module          | ELECTRICAL SPECIFICATION     |      |      | NOTES                                   |
|---|------------------------------|------|------|---|
|   | Min.                         | Typ. | Max. |   |
| <b>Maximum ratings</b>                                    |                              |      |      |   |
| Input Voltage (Vdc)                                       | -0.3                         |      | 1200 |   |
| Operating Temperature ( )                                 | -25                          |      | 70   |   |
| Storage Temperature ( )                                   | -40                          |      | 85   |   |
| Output Current (mA)                                       |                              |      | 350  |   |
| <b>Input Characteristics</b>                              |                              |      |      |   |
| Operating Input Voltage (Vdc)                             | 100                          |      | 1000 |   |
| Maximum Input Current (mA)                                |                              |      | 120  | Vout=24V, Full load                     |
| <b>Output Characteristics</b>                             |                              |      |      |   |
| Output Voltage Set Point (%Vset)                          | -3                           |      | +3   | With a 1.0% trim resistor               |
| Output Voltage Regulation (%Vset)                         | Over Line                    | -1   | +1   | Vin=100~1000Vdc                         |
|   | Over Load                    | -2   | +2   | I <sub>o</sub> =Min to Full Load        |
|   | Over Temperature             | -2   | +2   | T <sub>a</sub> =-25 to 70               |
|   | Total output range           | -2   | +2   | Over load, line, temperature regulation |
| Output Voltage Ripple and Noise(mV) (5Hz~20MHz bandwidth) | Peak-to-Peak                 |      | 500  | Full Load                               |
|   | RMS                          |      | 100  | Full Load                               |
| Output Voltage Over-shoot at Start-up (%Vset)             |                              |      | 5    | Vin=400V, Turn on                       |
| Output Voltage Under-shoot at Power-Off (mV)              |                              |      | 100  | Vin=400V, Turn OFF                      |
| Efficiency (%)  |                              | 75   |      | Vin=400V, Vout=24V, Full load           |
| <b>Physical</b>   |                              |      |      |   |
| Size (mm)   | 4.72"×1.8"×3.23" (120×46×82) |      |      |   |
| Weight (kg)   |                              | 0.24 |      |   |

**NOARK**

Tel: 86-21-37791111  
Fax: 86-21-37791199  
[www.noark-electric.com](http://www.noark-electric.com)  
E-mail: [Asia@noark-electric.com](mailto:Asia@noark-electric.com)



CBRIEF201206EN