

## Traffic detector VEK MNE1 / VEK MNE2



## Notes

© Copyright 2015 by

**FEIG ELECTRONIC GmbH**

Lange Straße 4

D-35781 Weilburg

Tel.: +49 6471 3109-0

[www.feig.de](http://www.feig.de)

**Version: 2015-09-14**

VEK MNE1 / VEK MNE2

This edition renders all previous editions invalid.

The information in this document is subject to change without notice.

**Without FEIG ELECTRONIC's prior written permission, it is not permitted to produce complete or partial copies and reproductions of this manual and translations into other languages. It is also prohibited to store total this manual on modern information carriers for manipulation purpose in data processing systems**

The compilation of the information in this document is based on our best knowledge and belief. *FEIG ELECTRONIC GmbH* accepts no responsibility for the correctness and completeness of the information in this manual. *FEIG ELECTRONIC GmbH will not be held liable for consequential damages arising as the result of incorrect or incomplete information.*

Since it is impossible to avoid mistakes despite our sincerest efforts, we are always grateful if these are pointed out.

The installation recommendations provided in this document are based on favorable conditions. *FEIG ELECTRONIC does not provide any warranty for the proper operation of the traffic detector in foreign system environments.*

*FEIG ELECTRONIC GmbH does not warrant the material described herein to be free of third party industrial property rights. With this document, FEIG ELECTRONIC GmbH does not issue any licenses to its own or others patent rights or industrial property rights.*

Warranty claims against *FEIG ELECTRONIC GmbH* can only be made by the purchaser and are not transferable. *FEIG ELECTRONIC GmbH's* warranty obligation extends only to products supplied by *FEIG ELECTRONIC GmbH*. The warranty excludes any liabilities for the entire system.

The description of the products, their application, capabilities and performance shall not be considered as warranted properties and are subject to technical change.

**Before using the traffic detector, please read the operating and safety instructions with care!**

## General information about this document

Language of the original instructions: Deutsch  
The following characters are used in the functional description to point out the different danger zones and useful hints.

 **ATTENTION** indicates that a potential risk to persons exists, if the procedure is not carried out as described.

 **WARNING** indicates that the controller is at risk of being damaged.

 indicates information that is important for the operation of the device.

 indicates useful information that is relevant but not essential to the utilization of the device.

# TABLE OF CONTENTS

<b>1</b>	<b>Safety Precautions and Warning Notes</b> .....	<b>4</b>
<b>2</b>	<b>Maintenance</b> .....	<b>4</b>
<b>3</b>	<b>Functional Description</b> .....	<b>5</b>
3.1	Vehicle Detection System .....	5
3.2	Adjustment .....	5
3.3	Output Options .....	5
3.4	Multiplex-Procedure .....	5
<b>4</b>	<b>Enclosure</b> .....	<b>6</b>
<b>5</b>	<b>Technical Specifications</b> .....	<b>7</b>
<b>6</b>	<b>Licenses and Directives</b> .....	<b>8</b>
<b>7</b>	<b>Installation Instructions</b> .....	<b>9</b>
7.1	Installation Location .....	9
7.2	Pin Assignment .....	9
<b>8</b>	<b>Ordering Code</b> .....	<b>10</b>
<b>9</b>	<b>Accessories</b> .....	<b>10</b>
<b>10</b>	<b>Elements on the Front</b> .....	<b>11</b>
10.1	LED Display.....	11
10.2	Push Buttons .....	12
10.3	DIP-switches .....	12
10.4	USB Socket.....	13
<b>11</b>	<b>Adjustment Options</b> .....	<b>14</b>
11.1	Sensitivity, On Threshold .....	14
11.2	Hysteresis, Off Threshold.....	15
11.3	Frequency .....	16
11.4	Hold Time .....	16
11.5	Output, Signal Shape .....	17
11.6	Invert Output Signal Behavior .....	17
11.7	Loop Error Behavior (Error Mode).....	17
11.8	Loop/Output Assignment.....	18
11.9	Pulse Timing Edge .....	18
11.10	Timing of Output Signals (On Delay, Off Delay, min. Duration).....	18
11.11	Direction Detection (Dir. Mode, Direction Mode) .....	19
11.12	Direction Logic.....	19
<b>12</b>	<b>Notes</b> .....	<b>26</b>

---

## 1 Safety Precautions and Warning Notes

---

** ATTENTION**

- The device must only be used for the purpose intended by the manufacturer.
- Store the operating instructions in an accessible location and pass it on to every user.
- Unauthorized modifications and the use of spare parts and accessories, which are not sold or recommended by the manufacturer of the equipment, can result in fires, electric shock and injury. Therefore, such measures lead to an exclusion of liability and the manufacturer will not accept liabilities.
- For the device, the manufacturer's warranty provisions in force at the time of purchase are valid. No liability is assumed for improper or wrong manuals or automatic adjustment of parameters of a unit or the improper use of a device.
- Do not open the enclosure.
- Repairs shall only be carried out by the manufacturer.
- The power source used must meet the requirements for SELV circuits and current limited power sources in accordance with EN 60950-1.
- Connecting, commissioning, maintenance, testing and adjustment work on the traffic detector must be carried out by qualified electricians with the relevant accident prevention training.
- Observe valid VDE regulations when handling devices that are exposed to electrical voltage. In particular, but not limited to, these are VDE 0100, VDE 0550/0551, VDE 0700, VDE 0711, VDE 0860, VDE 0105, as well as the fire and accident prevention regulations BGV A3 (previously VBG 4).
- The fact that an operational indicator turns off is no indication that the unit was disconnected from the power supply and that it is de-energized.
- All work on the unit and its installation must be carried out in accordance with the national electrical codes and local regulations.
- It is the responsibility of users or installers to make sure that the equipment is installed and connected in accordance with recognized engineering practice in the country of installation and relevant local regulations. Particular attention must be focused on cable dimensions, fuses, grounding, shutdown, isolation, insulation monitoring and overcurrent protection.
- The combined operation of extra low and low voltage on both outputs of the relays is not permitted!
- The round plug corresponds to the basic insulation properties. If the relay contacts carry voltages > 48 VAC/DC as well as for all -R230 versions, the isolation of all connecting cables of the 11-pin round plug must be designed for 230 V AC.
- The device must not be used as a safety unit in accordance with the Machinery Directive 2006/42 / EC, the Construction Products Directive 89/106 / EEC or any other safety regulation. In systems with potential risks, additional safety equipment is required!

---

## 2 Maintenance

---

- ** The unit does not contain parts that need servicing by the installer or user.

** ATTENTION** *Do not open the enclosure.*

---

### 3 Functional Description

---

The traffic detectors VEK MNE1 and VEK MNE2 are systems for the inductive recognition of vehicles that must be installed in control cabinets.

Properties:

- 1-channel (VEK MNE1) or 2-channel (VEK MNE2) inductive loop detector
- Compact plastic enclosure to be mounted in the control cabinet on sockets on DIN rails
- Automatic adjustment of the system after it is turned on
- Continuous readjustment of frequency drifts to neutralize environmental influences
- Sensitivity independent of loop inductance
- Fixed dwell times regardless of the degree of coverage of loops
- Frequency adjustment
- Direction sensing (only on VEK MNE2)
- Multiplexing method to avoid mutual interference of the loop channels
- LED indication of the loop conditions
- Galvanic isolation between loops and electronics
- Relay outputs
- USB-interface for the diagnosis and other adjustments

Adjustment options:

- Adjustments by means of a 8-pole DIP-switch and a 4-pole DIP-switch (only on VEK MNE2)
- two frequency levels
- Threshold of each channel in 255 steps (via 4 stage DIP-switch)
- Off hysteresis of 20-80% per channel
- Hold time 1-255 minutes and infinite per channel (via DIP-switch 5 minutes and infinite)
- Detector channels can be turned off
- Output adjustable as presence, pulse, direction signal (only on VEK MNE2) or loop failure

---

#### 3.1 Vehicle Detection System

---

An LC oscillator determines whether a metallic vehicle is located in the loop region or not. The output of the channel is controlled in accordance with the selected output function.

---

#### 3.2 Adjustment

---

The adjustment of the loop channels is carried out after turning on the detector or by pressing the front button for about 1 s. After a power failure, an automatic adjustment is carried out only when the operating voltage has been interrupted for a period of at least 0.5 s. The adjustment time is approximately 1 s, if the loop is not crossed by vehicles during this time.

Extended adjustment periods also result by external influences on the loop frequency, their causes must be identified and eliminated.

---

#### 3.3 Output Options

---

Depending on the selected output function, the outputs provide a presence signal, pulse signal, direction signal (only on VEK MNE2) or loop error. The adjustment of the pulse signal can also be used to select whether an output takes place when driving on or leaving the loop.

In addition to the inversion of the output signals, both outputs may be turned on or off individually and permanently.

---

#### 3.4 Multiplex-Procedure

---

The connected induction loops on the 2-channel traffic detector VEK MNE2 are turned on and off in rapid succession. Current always only flows through one loop. Mutual influence of the loops of a detector is thus prevented. Both loops connected to a detector can operate at the same frequency.

4 Enclosure

GBR

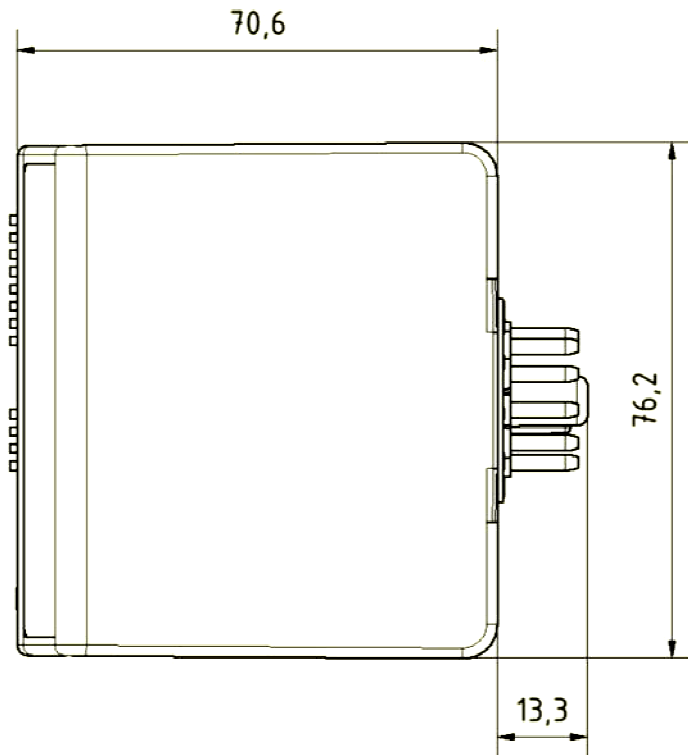

Side view

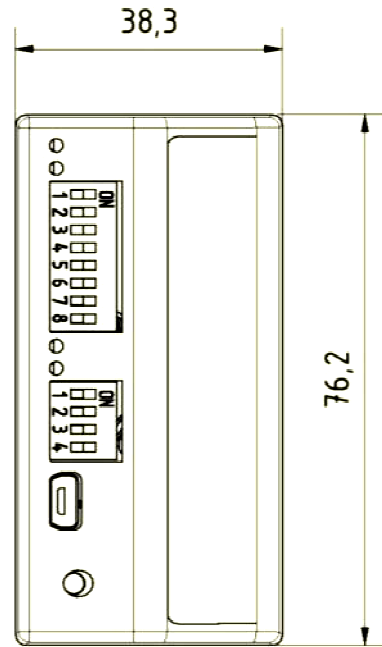

Front view (VEK MNE2)

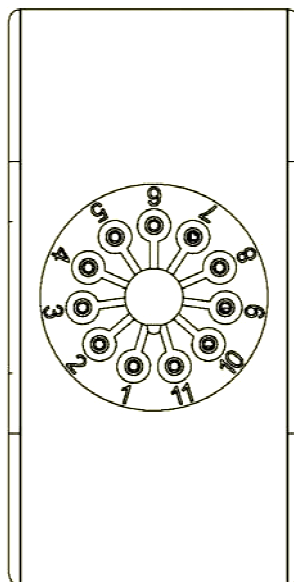

Rear view: Pins on the 11-pin round plug

## 5 Technical Specifications

Enclosure:	
Plastic enclosure	ABS, blue
Round plug, 11-pin	PPO, fiberglass-reinforced, black
Supply voltage	-R230: 100-240 V AC, 50-60 Hz -R24: 10-30 V AC/DC SELV, power source with limited output (EN 60950-1)
Power consumption	typ. 500 mW, max. 2 W
Protection class	-R230: II
Ambient temperature	-37 °C to +70 °C
Storage temperature	-40 °C to +85 °C
Relative humidity	max. 95 % non-condensing
Loop inductance range:	20-700 uH
Recommended loop inductance:	100-300 uH
Frequency of operation	30-130 kHz
Sensitivity	0,01 % to 2,55 % ( $\Delta f/f$ ) in 255 steps
max. Loop feed cable	200 m
max. internal resistance of loop	20 $\Omega$ , incl. feed cable
Loop inputs	1 kV, galvanic insulation
Cycle-/response time	12 ms
Limiting speed for passenger cars:	
with presence detection	max. 200 km/h
with direction recognition	max. 200 km/h for a 2 m loop head gap
Outputs:	
Relays	-R230: 2 A; 230 V AC; 60 W / 125 VA -R24: 2 A; 48 V AC/DC; 60 W / 125 VA
Connections:	
Inductive loops, power supply, controlled outputs	common on 11-pin round plug with base isolation
USB-interface	USB socket Mini-AB, 5-pin
USB-interface	virtual serial interface

## 6 Licenses and Directives

GBR

**Declaration of Conformity****FEIG  
ELECTRONIC**

in accordance with the  
**Electromagnetic Compatibility (EMC)**  
**Directive 2004/108/EC,**

**RoHS 2 Directive 2011/65/EU**  
**and**  
**Low Voltage Directive 2006/95/EC**

Product Manufacturer : **FEIG ELECTRONIC GmbH**  
Lange Strasse 4  
D-35781 Weilburg  
Germany  
Phone +49 6471 3109 0

Product Designation : **VEK MNE1 / VEK MNE2**

Product Description : 1- / 2-Channel Induction Loop Detector

FEIG ELECTRONIC GmbH herewith declares the conformity of the product with applicable regulations below.

Standards applied :

Electromagnetic compatibility (EMC) Part 6-3: Generic standards Emission standard for residential, commercial and light-industrial environments	<b>DIN EN 61000-6-3:2007 + A1:2011</b>
Electromagnetic compatibility (EMC) Part 6-2: Generic Standards Immunity for industrial environments	<b>DIN EN 61000-6-2:2005</b>
Information technology equipment - Safety Part 1: Generic requirements	<b>DIN EN 60950-1:2006 + A11:2009 + A1:2010 + A12:2011 + AC:2011 + A2:2013</b>

Weilburg-Waldhausen, 27/04/2015

Place & date of issue

Dirk Schäfer

Name and signature

This declaration attests to conformity with the named Directives but does not represent assurance of properties.  
The safety guidelines in the accompanying product documentation must be observed.



## 7 Installation Instructions

### 7.1 Installation Location

#### ATTENTION

Traffic detector VEK MNE<sub>x</sub> shall be installed into a switchboard or switchboard-like enclosure. The choice of the installation location must be such that the operation of the traffic detector cannot be impaired by humidity, dust or dripping water.

### 7.2 Pin Assignment

The table below shows the different pin assignments of the 11-pin round plug for the different pin-outs –A .. –G.

Pin as- signment	Pins on 11-pin round plug										
	1	2	3	4	5	6	7	8	9	10	11
-A	L/24V	N/GND	NO2	COM2	NC1	COM1	L1a	L1b	-	NO1	NC2
-B			NO2	-	COM1	NO1	L1a	L1b	COM2	NC1	NC2
-C			NC2	COM2	NC1	COM1	L1a	L1b	-	L2a	L2b
-D			NO2	COM2	NO1	COM1	L1a	L-Com	L2a	NC1	NC2
-E			L1a	L1b	L2a	L2b	NO2	COM2	NC2	NO1	COM1
-F			L1a	L1b	L2a	L2b	NC2	COM2	-	NC1	COM1
-G *			COM1+2		NO1	NC1	(L2a)	(L2b)	L1a	L1b	(NO2)

L / 24V      -R230: L  
                   -R24: 10-30 V AC/DC

N / GND      -R230: N  
                   -R24: GND

L1a, L1b      Inductive loop terminal channel 1  
 L2a, L2b      Inductive loop terminal channel 2  
 L-Com         common terminal Inductive loop channels 1 and 2, special assignment

NO1, NO2     normally open contact                    Output 1 or output 2  
 NC1, NC2     normally closed contact                 Output 1 or output 2  
 COM1, COM2   common contact                            Output 1 or output 2  
 COM1+2       common terminal for a common contact output 1 and 2, special assignment



*In addition, the inversion settings of relay contacts may need to be observed!  
 I.e. normally open contacts may be represented as normally closed contacts and vice versa.*

#### ATTENTION

*On the units of the version R230, all connecting cables of the 11-pin round plug must be rated at 240V. I.e., normally open contacts may be represented as normally closed contacts and vice versa.*

#### ATTENTION

*When extra low voltage (e.g. 24 V DC) and low voltage (e.g. 230 V AC) are being used, it is not permitted to mix the operation of the two outputs !*

\* toekomstige uitbreiding

## 8 Ordering Code

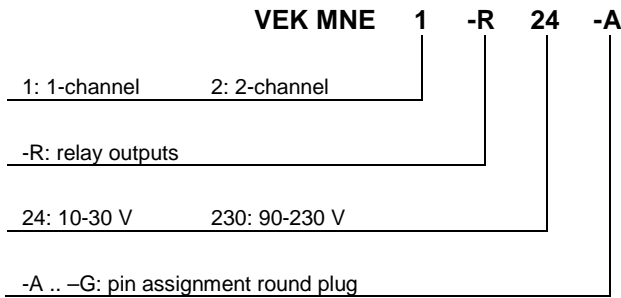

### Examples of standard versions:

<b>VEK MNE1-R24-A</b>	1-Channel traffic detector, relay, 24 V power supply, pin assignment -A
<b>VEK MNE1-R230-A</b>	1-Channel traffic detector, relay, 230 V power supply, pin assignment -A
<b>VEK MNE2-R24-C</b>	2-Channel traffic detector, relay, 24 V power supply, pin assignment -C
<b>VEK MNE2-R230-C</b>	2-Channel traffic detector, relay, 230 V power supply, pin assignment -C

## 9 Accessories

The following accessories are available:

Part No.	Description	Description
0185	VEK E socket	11-pin socket with screw terminals for mounting on DIN rails.
4405	VEK USB-cable	2.0m USB interface cable with USB type A connector and USB type mini-B connector.



Registered users may download the *Detector tool* service program free of charge from the download area of the FEIG ELECTRONIC GmbH homepage at <http://www.feig.de>.

## 10 Elements on the Front

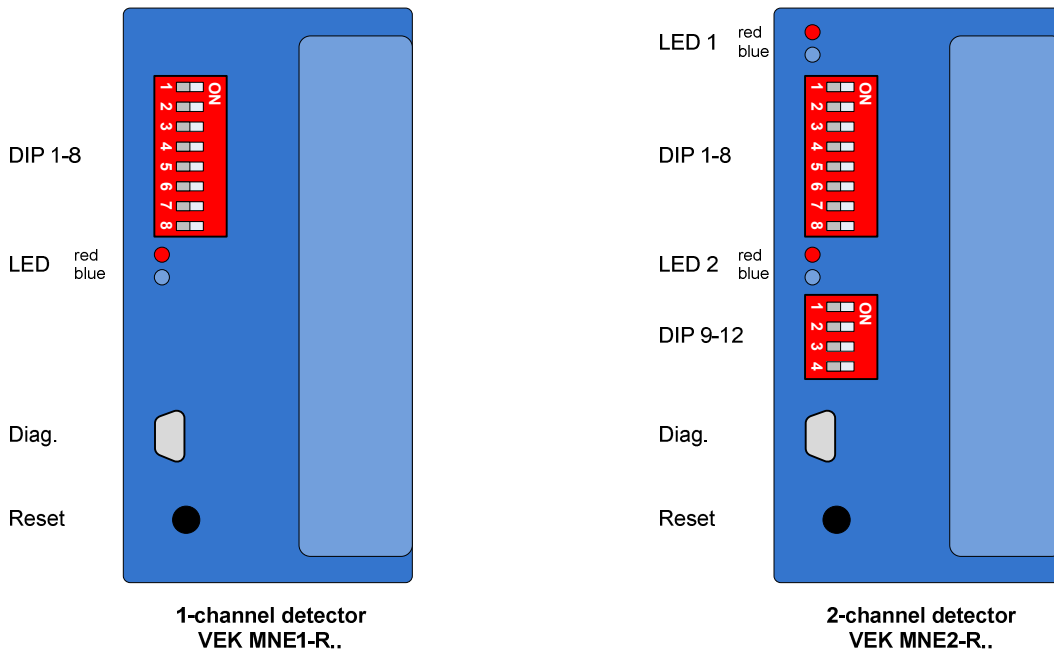

### 10.1 LED Display

The front of the detector has 2 LEDs to indicate the detector status of each loop channel.

LED red	LED blue	Description
off	off	Supply voltage missing
off	an	Loop free, detector ready
an	an	Object detected on loop
an	off	Loop failure
-	flashes, 5 Hz	Frequency alignment running
-	flashes, 1 Hz	Loop failure repaired or overwritten setting *
flashes	flashes	Frequency output after alignment (see example)

Example: Frequency output via LED for 57 kHz:

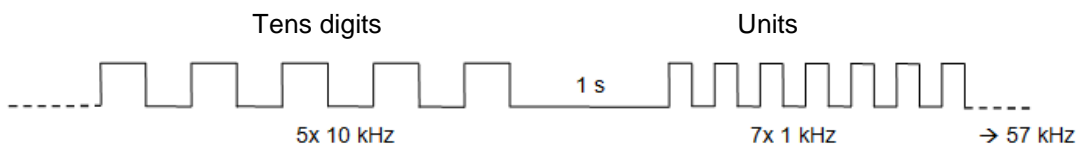

**i** The frequency output for loop channels 1 and 2 is sequential.

\* Indication, that the detector is operational again after a previously resolved loop failure.

† Change(s) by the service program of one or more settings via the USB interface

## 10.2 Push Buttons

The following functions are activated by pressing the reset button on the front panel.

Pressing push button	LED-display channel 1	Operation
1 s	red LED flashes	Triggers a hardware reset with recalibration and resets the LED output for resolved loop faults
5 s	blue LED flashes	Triggers default / factory settings *





 Only LEDs on channel 1 are used to display the activation via the push button!

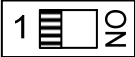

## 10.3 DIP-switches

The front of the 1-channel detector VEK MNE1 has an 8-pin DIP-switch to define settings-. For this purpose, the 2-channel detector VEK MNE2 is equipped with an 8-pin and a 4-pin DIP-switch.

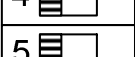
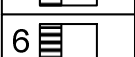
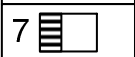



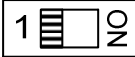

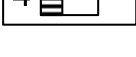
Example of the assignment of the DIP-switches:

### 2-channel detector VEK MNE2-R24/R230-C

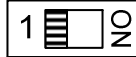
1 	Sense 1a
2 	Sense 1b
3 	Sense 2a
4 	Sense 2b
5 	Frequency
6 	Hold Time
7 	Output 2
8 	Edge 2

1 	Dir. Mode
2 	Dir. Logic
3 	Inv. Out 1
4 	Inv. Out 2

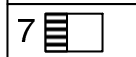
### 1-channel detector VEK MNE1-R24/R230-A

1 	Sense a
2 	Sense b
3 	Frequency
4 	Hold Time
5 	Output 2
6 	Edge 2
7 	Inv. Out 1
8 	Inv. Out 2

The illustrated DIP-switches show the assigned basic functions in the 1- and 2-channel standard variants VEK MNE1-R24-A, VEK MNE1-R230-A, VEK MNE2-R24-C and VEK MNE2-R230-C that are required for commissioning,

 For other device variants, the DIP-switch assignment may differ from the assignments and arrangements shown above. This is especially true for customized versions!

 Additional settings are available via the USB interface using the service program.

\* Settings that are made via the USB interface with the service program are also reset.

## 10.4 USB Socket

The USB socket is available for extended parameter definitions of the sensor and for the output of diagnostic data using the *Detector tool* service program and a commercially available USB cable.

In addition to the settings defined via DIP-switches, additional settings for the sensitivity, off hysteresis, hold time, behavior under loop errors, output functions, direction detection and activation- or release delays of relay are possible.

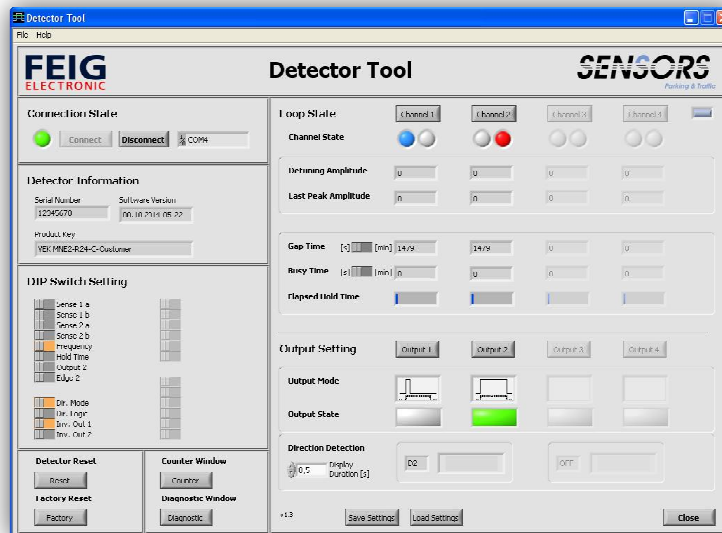

Similarly, current data such as loop frequency, detuning of the inductive loop, last maximum detuning, last availability period, time between two assignments, elapsed hold time, state of the relay output and the detected direction of travelling are displayed for the diagnosis.

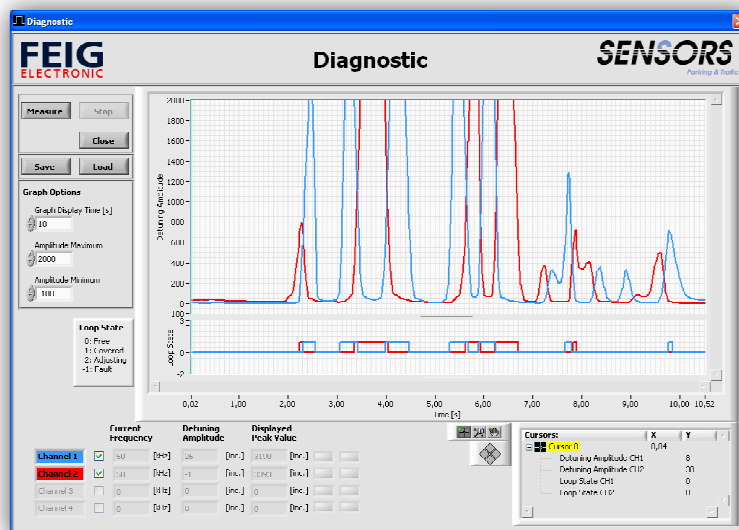

Time characteristics to detune the inductive loops and relay outputs are displayed in the diagnostic window.

Further information can be found in the separate documentation of the service program *Detector Tool*.



Registered users may download the *Detector Tool* service program free of charge from the download area of the FEIG ELECTRONIC GmbH homepage at <http://www.feig.de>.

## 11 Adjustment Options

The adjustments described below are entered either via the associated DIP-switches or via the USB interface using the service program. All main default settings are associated with the DIP-switches. As a rule, commissioning may be completed without the service program.

- i** The settings entered via the USB interface, can be reset to the factory settings by triggering the basic / factory settings (see section 10.2).

Legend of the table:

- ( ) Standard types, as well as the names in the service program *Detector tool* are specified in brackets printed on traffic sensors.

**DIP** Entries in this column show the settings for the DIP-switches

**USB** Entries in this column indicate values or settings that are possible via the USB interface using the service program *Detector Tool*.

- i** Settings entered via the USB interface, which do not match the current DIP-switch positions are indicated by the blue flashing LED.

### 11.1 Sensitivity, On Threshold

In the range of 0.01% - 2.55%  $\Delta f/f$  the sensitivity of each channel can be selected in 255 steps.

- !** To minimize interference, the sensitivity should only be set as *high as necessary*. I.e. the response threshold should be as high as possible.

DIP Sense a	DIP Sense b	USB (response threshold)	Sensitivity ( $\Delta f/f$ )
ON	ON	10	0,01 % <b>Stage high</b> <i>Highest sensitivity</i>
		20	0,02 %
		30	0,03 %
OFF	ON	40	0,04 % <b>Stage medium-high</b>
		50	0,05 %
		:	
		150	0,15 %
ON	OFF	160	0,16 % <b>Stage medium-low</b>
		170	0,17 %
		:	
		630	0,63 %
OFF	OFF	640	0,64 % <b>Stage low</b> (factory setting)
		650	0,65 %
		:	
		1000	1,00 %
		:	
		2550	2,55 % <i>lowest sensitivity</i>

Typically, the sensitivity setting is adjusted in large steps with the response threshold selected to be no higher than 640.

In applications where it is necessary to distinguish between vehicles, values of settings higher than 640 and fine adjustments can be utilized. A large loop (e.g. 10.0 m x 2.5 m) permits selective detection of busses when the threshold value is set correspondingly high (> 1000).

## 11.2 Hysteresis, Off Threshold

To avoid the busy signal dropping out from time to time, i.e. when vehicles with a high base are utilized as articulated buses, trams, trucks with trailers, etc., it is possible to change the switching hysteresis. Uninterrupted detection of critical vehicles is then possible even at low sensitivity.

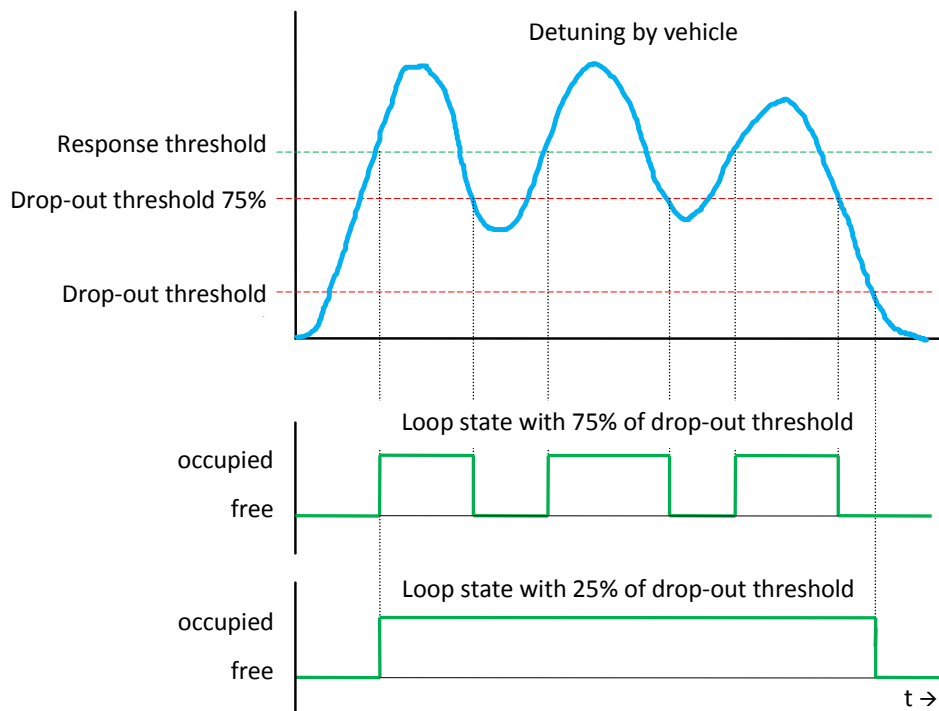

The service program displays the calculated off threshold that results based on the selected response threshold and the percentage hysteresis.

DIP	USB	Description
	20%	Lowest off threshold 20% of response threshold value (boost)
	:	
	75%	(factory setting)
	:	
	80%	Highest off threshold 80% of the response threshold

Examples: Response threshold 160 (step medium-low)

Hysteresis 75% → off threshold:  $0.75 * 160 = 120$

Hysteresis 20% → off threshold:  $0.20 * 160 = 32$



The hysteresis settings for the off threshold can only be changed in the service program!



## 11.3 Frequency

The adjustment of the operating frequency *avoids coupling effects*.

-  Couplings may be caused by other sensors on adjacent loops or loop cables. Therefore, it is important that two or more sensors with adjacent loops do not operate on the same loop frequency. In this case, the minimum frequency spacing must be 10 kHz.

DIP		Description
OFF	Low	Low frequency ( <i>factory defaults</i> )
ON	High	High frequency
	None	Loop channel turned off

A flashing sequence displays the current operating frequency of the loops in kHz or it may be read out with the service program *Detector Tool*. (see chapter 10.1)

-  It is recommended to adjust the loop of one sensor to the same frequency. The multiplexing method ensures that no coupling takes place between the loops of one sensor.
-  For loop whose inductance is outside of the recommended range (see Chapter 4), the available frequency range may be limited.
-  Loop channels without permanently connected induction loops should be disabled in the service program. Otherwise, it is automatically polled whether a valid induction loop has been connected. In the worst cases, this can lead to influence on the intact loop channel.

## 11.4 Hold Time

On the sensor, it is possible to set separate hold times between 1 and 255 minutes for each channel. 0 Minutes correspond to infinite hold time. If the loop of a sensor channel is covered longer than the selected hold time, the sensor channel performs the measurement again. The existing detuning of the loop channel is cleared.

DIP	USB	Hold time
ON	0	Infinite hold time
	1	1 Minute hold time
	:	
OFF	5	5 Minute hold time ( <i>factory defaults</i> )
	:	
	255	255 Minute hold time

-  For example, vehicles that park on the loop may automatically be removed from the calculation after the hold time has expired by adjusting the hold time.  
In addition, proper adjustment of the selected hold time can avoid permanent tripping caused by faults.



## 11.5 Output, Signal Shape

The following signal shapes may be selected for the outputs:

DIP	USB	Output, signal shape
OFF	Presence	Continuous signal output (factory defaults)
ON	Pulse	Pulse output
	On	Continuous output turned on
	Off	Continuous output turned off
	General Fault	Output for collective message

 To adjust the output modes listed above the direction logic of the VEK MNE2 may not be enabled! I.e. you must select OFF on DIP-switch Dir Mode and. in the service program.

## 11.6 Invert Output Signal Behavior

Inverted or non-inverted signal output may be selected for all output modes. This enables open-circuit or closed-circuit-principle for the relays.

DIP	USB	
OFF	Not Inverted	Not inverted signal output (open-circuit-principle)
ON	Inverted	Inverted signal output (closed-circuit-principle)

 The service tool can show a detailed representation of the currently used relay's operating principle (open-circuit or closed circuit)!

## 11.7 Loop Error Behavior (Error Mode)

When *Error mode* is selected in the settings, it specifies the behavior of the loop channel when a loop fault occurs and what condition the hardware output assumes.

DIP	USB	Output signal for a Loop Error
	Covered	same as for the covered loop (factory defaults)
	Free	same as for the free loop

**Loop Fault** Only with the check box selected in the service program (factory default), the errors associated with this loop channel are passed on. The field *Error Mode* displays *Active*. Otherwise, *Inactive* is displayed.

**Adjusting** If the check box is checked, the time during the frequency adjustment will be considered in addition as error condition of the loop. In the factory defaults, the check box is not checked.

 The settings for behavior on loop error can only be changed in the service program!

## 11.8 Loop/Output Assignment

Each output may be assigned to a loop channel or, when the direction detection is activated, a specific direction.

DIP	USB	Assignment of Hardware Output
	None	No loop channel or direction has been assigned or output inactive
	Channel 1 <sup>1</sup>	Loop channel 1 assigned (Factory default for output 1)
	Channel 2 <sup>1</sup>	Loop channel 2 assigned (Factory default for output 2)
	Direction A <sup>2</sup>	Output controlled by direction of travel A (Factory default for output 1)
	Direction B <sup>2</sup>	Output controlled by direction of travel B (Factory default for output 2)
	Direction A&B <sup>2</sup>	Output is controlled for both directions

<sup>1</sup> Valid only for presence detection with the direction detection switched off!

<sup>2</sup> Valid only when direction detection was activated!



The assignment of the loop channels to the hardware outputs can only be changed via the service program!

## 11.9 Pulse Timing Edge

The following signal shapes may be selected for the outputs if you have set the outputs to pulse output. :

DIP	USB	Pulse output
OFF	Entry	When covering the loop (factory defaults)
ON	Leave	When the loop is free



The default setting for the pulse duration is 200 ms. It can be changed in 100 ms steps in the service program *Detector Tool*.

## 11.10 Timing of Output Signals (On Delay, Off Delay, min. Duration)



The timing properties of the output signals can only be changed with the service program!

For the hardware-based output signals the on delay, minimum duration and the off delay can be adjusted over the range 0-25500 ms in 100 ms steps.

Factory defaults:

On Delay	0 ms
Off Delay	0 ms
min. Duration	200 ms

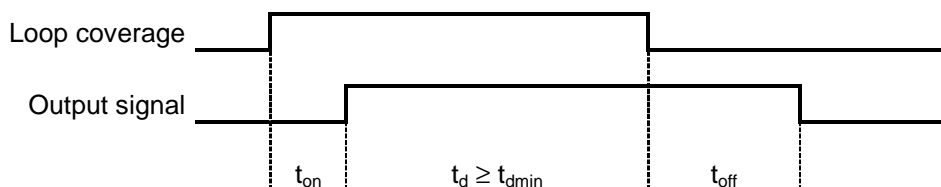

$t_{on}$ : On Delay  
 $t_{off}$ : Off Delay  
 $t_{dmin}$ : Min. Duration  
 $t_d$ : Signal duration



If the loop is free before the ON delay has expired, there is no signal output!

## 11.11 Direction Detection (Dir. Mode, Direction Mode)

**i** The settings for direction detection can only be selected for the 2-channel traffic detector VEK MNE2 .

DIP	USB	Direction detection
OFF	OFF	turned off <i>(factory defaults)</i>
ON	ON	turned on

Complex algorithms have been integrated into the 2-channel detector to provide direction-dependent detection of vehicles on double-loops. The directional logic generates logic output signals that may be output via the hardware outputs, depending on settings. Simultaneously, the detector independently counts the logic signals.

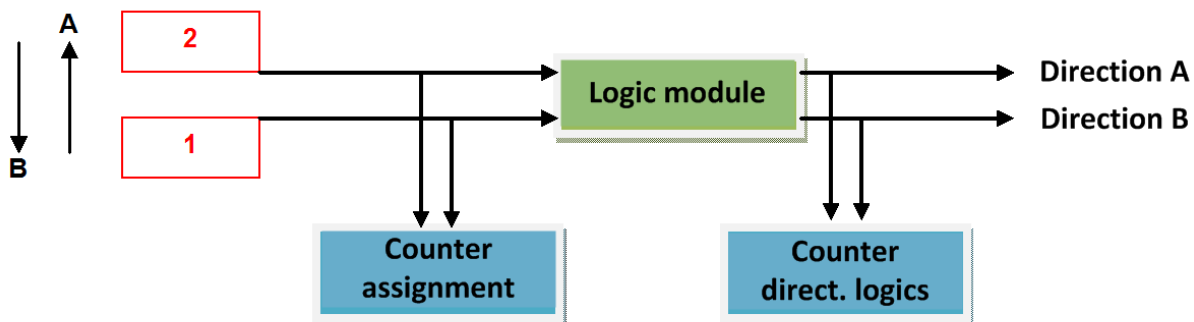

In every logic, the loop that is covered first determines the count or direction of travel. For example, if loop 1 is covered first, the output is issued and the count in direction A is performed.

The factory default setting issues the output for the direction of travel A via hardware output 1 and for direction of travel B via hardware output 2. However, the assignment of the outputs may be changed.. (see chapter 11.8)

**i** The service program *Detector Tool* displays the counters. It should be noted that the counters overflow at 65535 (2<sup>16</sup>) and are cleared automatically.

**i** *The counts in the detector are not protected against loss of power!*

## 11.12 Direction Logic

Depending on the application, different evaluation logics can be selected in the logic module.

**!** *The adjustment of the direction of logic is possible only with activated direction detection!*

DIP	USB	Direction Logic
OFF	D2	Continuous signal 2 <i>(factory defaults)</i>
	D1	Continuous signal 1
	DB	Continuous signal, both loops
ON	F1	Wrong-direction driver 1
	F2	Wrong-direction driver 2
	FE	Feig
	SF	Loop free
	BS	both loops
	PB	Parking bay
	OFF	no logic selected

The following brief description refers to the different logics for direction detection.

Direction Logic	Signal output	Signal off	Remark
D1 – continuous signal 1	Coverage 1st loop	Exit 1st. loop	Signal output in the opposite direction is active again if both loops were previously free.
DB – continuous signal both loops		Exit 2nd. loop	
D2 – continuous signal 2	Coverage 2nd loop		
F1 – wrong-direction driver 1	Coverage 2nd loop	<i>Pulse output with the selected minimum signal duration</i>  (default 200ms)	Correct behavior in slow-moving stop-start traffic and when maneuvering. Different behavior for wrong direction driver situations.
F2 – wrong-direction driver 2			Correct behavior for moving traffic maneuvering should not occur.
BS – both loops			Correct behavior in slow-moving stop-start traffic and when maneuvering.
FE – Feig	Exit 1st. loop		Detection of single vehicles and maneuvering vehicles. Stop-start traffic should not occur
SF – loop free	Exit 2nd. loop		For short entries and exits
PB – parking bay	direction dependent		

The detailed operation for various traffic situations is clearly shown by the following tables.

Explanatory Notes on the table:.



marked direction logic xx = logic with miscounting for this traffic situation

Imp on Pulsed signal traveling dir. A  
continuous signal on

Imp off Pulsed signal traveling dir. B  
continuous signal off



Loop free



Loop covered

11.12.1 Single vehicle

	D2	D1	DB	F1	F2	FE	SF	BS	PB	
									Ri1	Ri2
		on	on							
	an	---	---	Imp	Imp			Imp		
	---	off	---			Imp				Imp
	off		off				Imp		Imp	

11.12.2 Stop-start traffic

	D2	D1	DB	F1	F2	FE	SF	BS	PB	
									Ri1	Ri2
		on	on							
	on	---	---	Imp	Imp			Imp		
	---	off	---			Imp				Imp
	---	on	---							
	off	---	---						Imp	
	on	---	---	Imp	Imp			Imp		
	---	off	---			Imp				Imp
	off		off				Imp		Imp	

11.12.3 Wrong-direction driver 1

	D2	D1	DB	F1	F2	FE	SF	BS	PB	
									Ri1	Ri2
		on	on							
	on	---	---	Imp	Imp			Imp		
	off	---	---							
		off	off	Imp	Imp					

11.12.4 Wrong-direction driver 2

	D2	D1	DB	F1	F2	FE	SF	BS	PB	
									Ri1	Ri2
		on	on							
	on	---	---	Imp	Imp			Imp		
	---	off	---			Imp				Imp
	---	on	---							
	off	---	---						Imp	
		off	off		Imp					

11.12.5 Maneuvering 1

	D2	D1	DB	F1	F2	FE	SF	BS	PB	
									Ri1	Ri2
		on	on							
	on	---	---	Imp	Imp			Imp		
	off	---	---							
	on	---	---							
	---	off	---			Imp				Imp
	off		off				Imp		Imp	

11.12.6 Maneuvering 2

	D2	D1	DB	F1	F2	FE	SF	BS	PB	
									Ri1	Ri2
		on	on							
	on	---	---	Imp	Imp			Imp		
	---	off	---			Imp				Imp
	---	on	---							
	off	---	---							Imp
	on	---	---	Imp	Imp			Imp		
	---	off	---			Imp				Imp
	off		off				Imp		Imp	

11.12.7 Wrong direction driver in start-stop traffic

	D2	D1	DB	F1	F2	FE	SF	BS	PB	
									Ri1	Ri2
		on	on							
	on	---	---	Imp	Imp			Imp		
	---	off	---			Imp				Imp
	---	on	---							
	off	---	---							Imp
		off	off		Imp					

11.12.8 Cross traffic

	D2	D1	DB	F1	F2	FE	SF	BS	PB	
									Ri1	Ri2
		on	on							
	on	---	---	Imp	Imp			Imp		
	---	off	---			Imp				Imp
	---	on	---							
	off	---	---						Imp	
		off	off		Imp					

**!** All logics except for the logic PB in direction 1 supply in this traffic situation miscounts since they count on instead of off signals!

11.12.9 Direction Logics "Parking Bay"

This direction logic is used for short entries and exits. The impairment of the counting process by cross traffic on loop 1 is suppressed in this logic. It is irrelevant whether loop 1 is placed into the through road or in the maneuvering area.

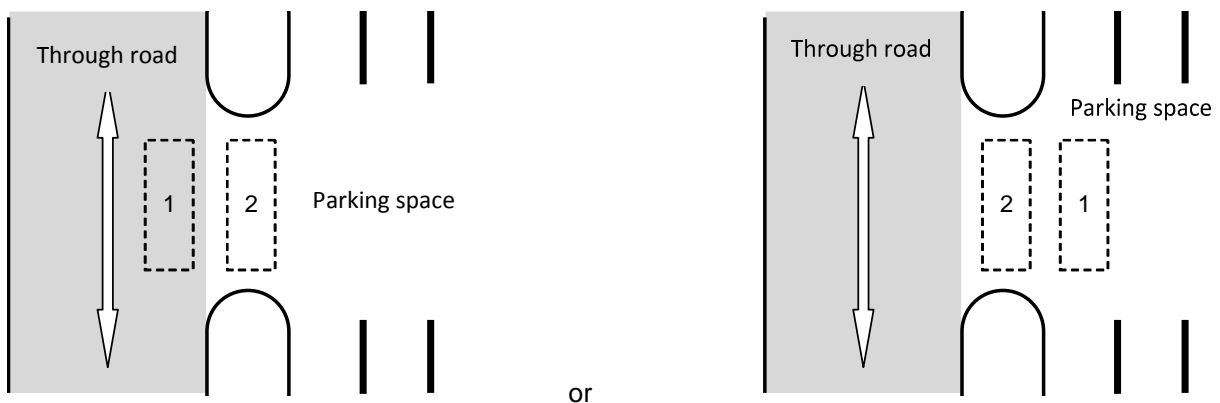

**!** The placement of loops depends on the direction to be expected for start-stop situations. In traveling direction 1 → 2 no tailback may occur! In the direction of travel 2 → 1, vehicles are also counted correctly in start-stop situations, but it is necessary that the vehicle gap release one loop respectively.



**Logics when the direction of travel is 1 → 2**

- The counting pulse occurs once both loops were completely crossed
- correct counting of single vehicles
- correct counting also when maneuvering
- Traffic jams and start-stop situations may not occur when the direction of travel is 1 -> 2 !

**Logics when the direction of travel is 2 → 1**

- The counting pulse occurs as soon as loop 2 is left in the direction of loop 1.
- Correct counting even with cross-traffic
- proper counting in start-stop traffic
- Correct counting also when maneuvering a single vehicle
- Maneuvering within a column must not occur!

